



MILLWORK CATALOG

MOULDING, MILLWORK
& STAIRS

2026 EDITION



TABLE OF CONTENTS

MOULDING

CEILING

CROWN	6
BED, COVE	8

DOOR & WINDOW

BACK BAND, BRICK MOULD	10
CASING	12
DOOR STOP	16
GLASS BEAD, MULL COVER, T-ASTRAGAL	17
WATER TABLE, WINDOW STOOL	18

WALL & CABINET

BATTEN STRIP, LIP MOULD	19
PANEL MOULD	20
PANEL STRIP, PICTURE MOULD, CHAIR RAIL ...	21
HAND RAIL	22

PATTERN STOCK

NICKEL GAP, BEADED CEILING	23
----------------------------------	----

FLOOR

BASE	24
BASE, BASE CAP, BASE SHOE	28

GENERAL PURPOSE

CHAMFER STRIP, INSIDE & OUTSIDE CORNERS ...	29
LATTICE, NOSING, SCREEN MOULD	30
ROUNDS	31

S4S

RAW PINE, PRIMED PINE	33
RADIATA C+PINE, OAK, KNOTTY ALDER, POPLAR, MAPLE ...	34
SCREEN STOCK, MDF BOARDS, PARTICLE BOARDS ...	35
PRIME FINGER-JOINTED BOARDS	36

PREFINISHING MOULDING

CEILING, DOOR & WINDOW, FLOOR	38
-------------------------------------	----

ACCESSORIES

CORNER BLOCKS, POLE SOCKETS, SHELF BRACKETS ...	39
---	----

SIMPLE CLEAN MOULDING

SIMPLE CLEAN MOULDING	40
-----------------------------	----

FIBERGLASS COLUMNS

PERMACAST COLUMNS, CAPS & BASE	43
--------------------------------------	----

BEAMS & MANTELS

WOOD-GRAINED, SMOOTH	44
WOOD-GRAINED STRAPS	45

DECORATIVE MILLWORK

BRACKET	46
CORBEL, KNEE BRACE, RAFTER TAIL	47
LOUVER, BOARD AND BATTEN SHUTTER	48

COFFMAN® STAIR PARTS

COFFMAN® STAIR PARTS

EASY STEPS TO CREATE A STAIRCASE	50
WOOD SPECIES	51
BALUSTERS	52
IRON NEWELS	58
IRON NEWELS, IRON SHOE & KNUCKLE	60
BOX NEWELS, POST SYSTEMS	61
RAIL SERIES	62
RAIL FITTINGS	66
ROSETTES, STARTING STEPS	70
SWAGELESS FITTINGS, HOLLOW TUBES, CABLE KNIT ...	71
STAIR ANATOMY	72

ATTIC STAIRS

AMERICAN STAIRWAYS, INC.

HUSKY DISAPPEARING STAIRWAY	74
-----------------------------------	----

LOUISVILLE LADDER

ELITE ALUMINUM LADDER	76
ENERGY EFFICIENT ALUMINUM LADDER	78

MARWIN

THE TITAN	80
-----------------	----

FAKRO® ATTIC STAIRS

FAKRO ATTIC STAIRS®

LMF-R FIRE RETARDANT METAL LADDER	82
LMP-R 12' FIRE RETARDANT METAL LADDER	83
LWB BASIC WOODEN FOLDING LADDER	84
LMB BASIC METAL FOLDING LADDER	85
LST METAL SCISSOR LADDER	86





DOOR & MILLWORK

MOULDING

CEILING CROWN

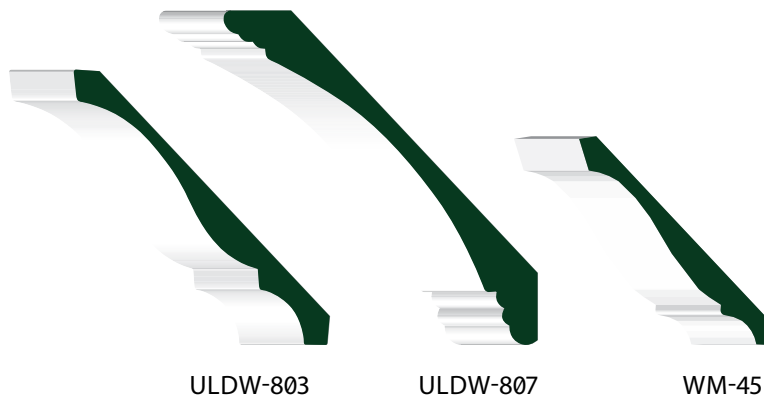
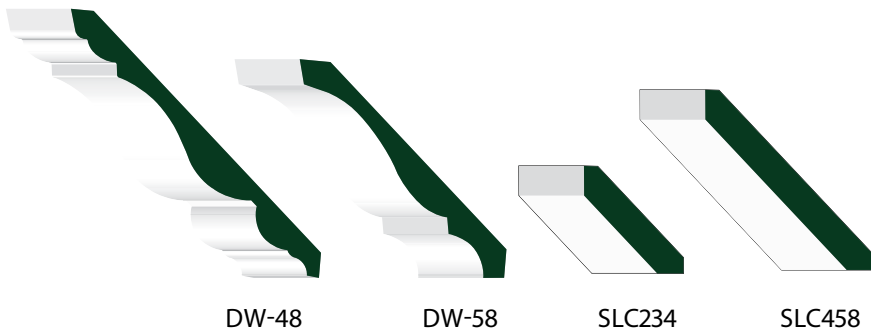
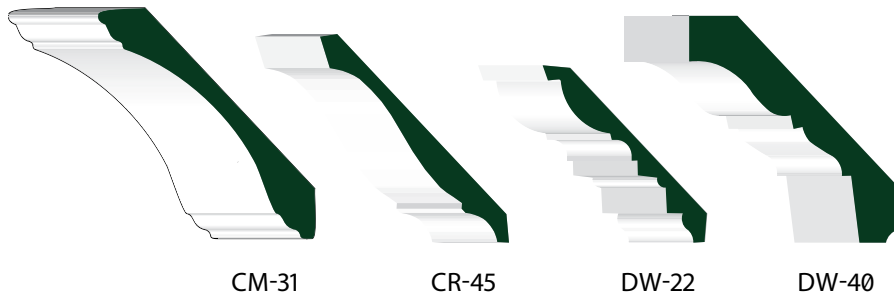
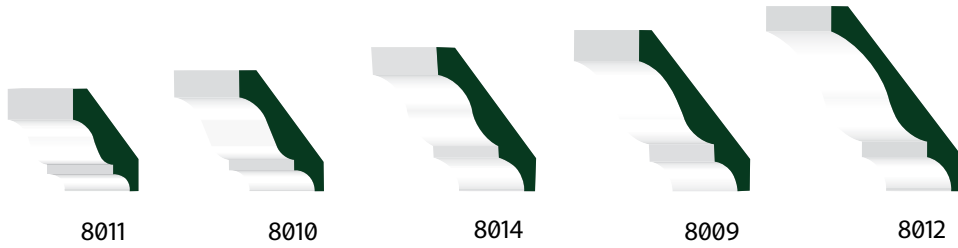

ITEM	SIZE	L	SOLID PINE	FJ	PRIMED FJ	MDF	FLEX	KNOTTY ALDER
8009	9/16" x 3-5/8"	12'	-	-	Z24	-	9C8	-
8009	9/16" x 3-5/8"	16'	-	6IB	6S9	Z80	-	-
8009	9/16" x 3-5/8"	RL	6B9	-	-	-	-	-
8010	9/16" x 2-3/4"	12'	-	-	Z23	-	9C9	-
8010	9/16" x 2-3/4"	16'	-	6IC	80P	-	-	-
8010	9/16" x 2-3/4"	8'	S76	-	-	-	-	-
8010	9/16" x 2-3/4"	RL	6BA	-	-	-	-	-
8011	9/16" x 2-1/4"	RL	6BB	-	-	-	-	-
8012	13mm x 4-1/4"	16'	-	-	-	35D	-	-
8012	9/16" x 4-1/4"	12'	-	-	12X	-	MD5	-
8012	9/16" x 4-1/4"	16'	-	6DZ	9G7	-	-	-
8012	9/16" x 4-1/4"	RL	6BC	-	-	-	-	EAA
8014	9/16" x 3-1/4"	RL	6BD	-	-	-	-	-
8012 (48"ISR)	9/16" x 4-1/4"	12'	-	-	-	-	6GB	-
8012 (96"ISR)	9/16" x 4-1/4"	12'	-	-	-	-	COZ	-
8012 (96"OSR)	9/16" x 4-1/4"	12'	-	-	-	-	CP5	-
CM-31	5/8" x 4-1/4"	16'	-	DDF	-	-	-	-
CR-45	9/16" x 5-1/4"	16'	-	-	Z97	-	-	-
DW-22	9/16" x 4-1/2"	16'	-	6LU	-	-	-	-
DW-22	9/16" x 4-1/2"	RL	6MB	-	-	-	-	-
DW-22 (96"ISR)	9/16" x 4-1/2"	12'	-	-	-	-	CP3	-
DW-40	1-1/4" x 5-5/8"	RL	6B6	-	-	-	-	-
DW-48	11/16" x 6-7/8"	16'	-	6M6	-	-	-	-
DW-48	11/16" x 6-7/8"	RL	6HM	-	-	-	-	-
DW-58	11/16" x 5-5/8"	16'	-	-	15Y	-	-	-
DW-58	11/16" x 5-5/8"	RL	6G5	-	-	-	-	-
DW-58	18mm x 5-5/8"	16'	-	-	-	1AH	-	-
SLC234	9/16" x 2-3/4"	12'	-	-	SC5	-	-	-
SLC234	9/16" x 2-3/4"	16'	-	-	SC3	-	-	-
SLC458	9/16" x 4-5/8"	12'	-	-	SC6	-	-	-
SLC458	9/16" x 4-5/8"	16'	-	-	SC4	-	-	-
ULDW-803	18mm x 7"	16'	-	-	-	4AB	-	-
ULDW-807	30mm x 8-1/2"	16'	-	-	-	4AD	-	-
WM-45	15mm x 5-1/4"	16'	-	-	-	MD9	-	-

BED



COVE

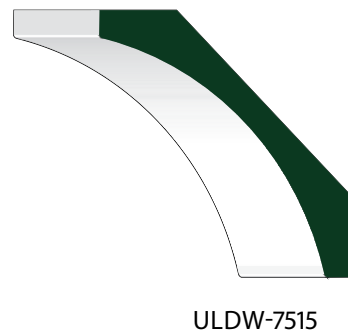
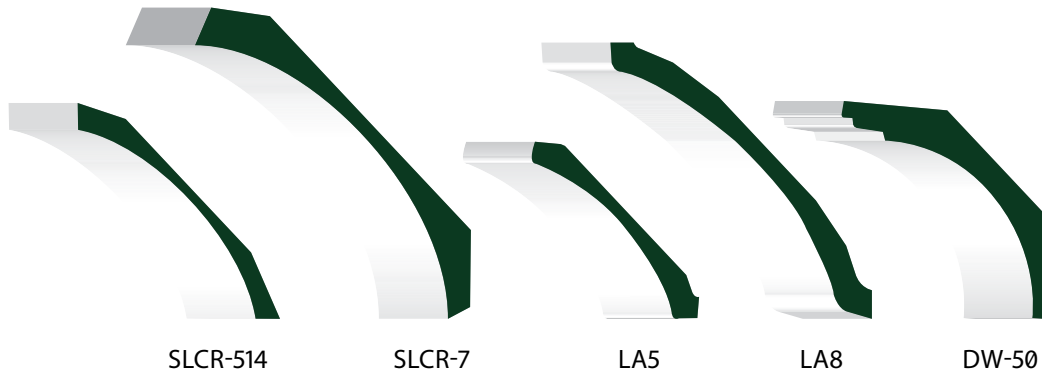
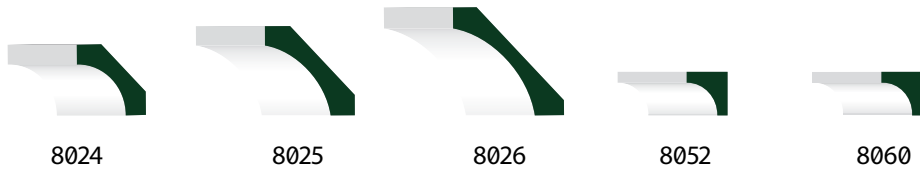

BED

ITEM	SIZE	L	SOLID PINE	FJ
8016	9/16" x 1-3/4"	8'	6E6	-
8016	9/16" x 1-3/4"	16'	-	9C1
8016	9/16" x 1-3/4"	RL	6BE	-
8018	9/16" x 2-1/4"	RL	6BF	-
8019	9/16" x 2-3/4"	RL	6BG	-
8020	9/16" x 3-1/4"	RL	6BH	-

COVE

ITEM	SIZE	L	SOLID PINE	FJ	PRIMED FJ	MDF	FLEX
8024	9/16" x 1-3/4"	8'	6E7	-	-	-	-
8024	9/16" x 1-3/4"	RL	6BI	-	-	-	-
8025	9/16" x 2-1/4"	RL	6BJ	-	-	-	-
8026	9/16" x 2-3/4"	RL	6BK	-	-	-	-
8052	3/4" x 3/4"	8'	6E9	-	-	-	-
8052	3/4" x 3/4"	RL	6BL	-	-	-	-
8052 (Oak Grain)	3/4" x 3/4"	12'	-	-	-	-	OD6
8060	3/4" x 7/8"	8'	6EA	-	-	-	-
8060	3/4" x 7/8"	RL	6BN	-	-	-	-
DW Cradle	1-1/2" x 2-1/2"	16'	-	-	16T	-	-
DW Cradle	1-1/2" x 2-1/2"	RL	MAI	-	-	-	-
DW-50	1-7/16" x 5-1/4"	16'	-	MAJ	-	-	-
DW-50	1-7/16" x 5-1/4"	RL	MAH	-	-	-	-
ULDW-50	35mm x 5-1/4"	16'	-	-	-	ZW3	-
LA5 Cove	17mm x 4-1/4"	16'	-	-	-	LA5	-
LA8 Cove	25mm x 6-3/4"	16'	-	-	-	LA8	-
SLCR-514	19mm x 5-1/4"	16'	-	-	-	4AX	-
SLCR-7	25mm x 7"	16'	-	-	-	4AW	-
ULDW-7515	27mm x 5-1/4"	16'	-	-	-	751	-

DOOR & WINDOW

BACK BAND, BRICK MOULD

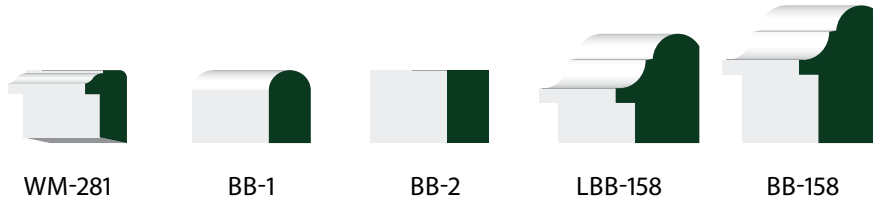

BACK BAND

ITEM	SIZE	L	SOLID PINE	PRIMED FJ	MATCHES CASING THICKNESS OF
BB-1	11/16" x 1-1/4"	16'	-	6SF	<1"
BB-158	1-3/8" x 2 1/8"	16'	-	6SH	1-1/6"
BB-2	11/16" x 1-1/4"	16'	-	6SG	<1"
LBB-158	1-3/8" x 1-11/16"	16'	-	6SI	5/8"
LWM-281	11/16" x 1"	17'	-	19X	9/16"
WM-281	11/16" x 1-1/8"	RL	6CI	-	9/16"

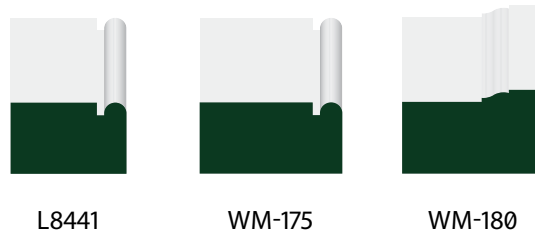

L8441 WM-175 WM-180

BRICK MOULD

ITEM	SIZE	L	SOLID PINE	FJ	PRIMED FJ	FLEX	FRAME SAVER	COMP	PVC	KNOTTY ALDER	MOHAG
L8441	1-1/16" x 1-5/8"	14'	-	6IN	Z29	-	-	-	-	-	-
WM-175	1-1/16" x 2"	7'	6EN	6L7	Z30	-	-	-	-	-	-
WM-175	1-1/16" x 2"	14'	-	6E3	-	-	-	-	-	-	-
WM-175	1-1/16" x 2"	RL	6CM	-	-	-	-	-	-	-	-
WM-180	1-1/4" x 2"	7'	-	6L9	T31	-	11C	11J	-	-	3CJ
WM-180	1-1/4" x 2"	8'	-	-	-	-	11D	11M	P26	EAJ	3CM
WM-180	1-1/4" x 2"	8'6"	-	-	T03	-	-	-	-	-	-
WM-180	1-1/4" x 2"	10'	-	-	-	-	-	-	-	EAK	-
WM-180	1-1/4" x 2"	12'	-	-	-	OCA	-	-	-	-	-
WM-180	1-1/4" x 2"	17'	-	-	6NN	-	-	-	-	-	-
WM-180	1-1/4" x 2"	RL	6GU	-	-	-	-	-	-	-	-
WM-180 (Set)	1-1/4" x 2"	3-0	-	-	Z31	-	-	-	-	-	-
WM-180 (Head)	1-1/4" x 2"	3-0	-	-	-	-	17A	-	-	-	-
WM-180 (Head)	1-1/4" x 2"	6-0	-	-	-	-	17B	-	-	-	-



DOOR & WINDOW CASING

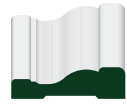

A COLONIAL
2-1/8"

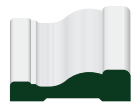

A COLONIAL
2-1/4"



A COLONIAL
2-1/2"

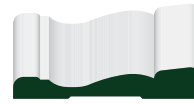

A COLONIAL
3-1/2"



C-11

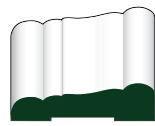

C-100



C-195



C-196



C-211



C-22



C-295



C-322



C-329



C-346



C-347



C-522



COVE
CASING



E CASING



FLUTED 3-3/8"



FLUTED 5-1/4"



H WEDGE



LC-11



MIXON



SLC



SLC DADO



STEP



ULDW-107



WM-306



WM-329



WM-356



WM-473

ITEM	SIZE	L	SOLID PINE	FJ	PRIMED FJ	MDF	FLEX	KNOTTY ALDER
A Colonial	5/8" x 2"	7'	-	Z56	-	-	-	-
A Colonial	5/8" x 2-1/8"	7'	-	1S2	Z33	-	-	-
A Colonial	5/8" x 2-1/8"	14'	-	6MF	Z98	-	-	-
A Colonial	5/8" x 2-1/8"	RL	11G	-	-	-	-	-
A Colonial	5/8" x 2-1/4"	7'	6FN	6FX	6GV	Z52	-	-
A Colonial	5/8" x 2-1/4"	10'	-	-	Z36	-	-	-
A Colonial	5/8" x 2-1/4"	9'	-	-	-	-	XRC	-
A Colonial	5/8" x 2-1/4"	14'	-	6GF	6GK	-	-	-
A Colonial	5/8" x 2-1/4"	RL	6DN	-	-	-	-	-
A Colonial (Set)	5/8" x 2-1/4"	3-0	Z17	-	Z37	-	-	-
A Colonial	5/8" x 2-1/2"	7'1"	6FO	6FY	6NU	-	-	-
A Colonial	5/8" x 2-1/2"	9'	-	-	-	-	OAE	-
A Colonial	5/8" x 2-1/2"	14'2"	-	6GH	9G9	-	-	-
A Colonial	5/8" x 2-1/2"	RL	6DQ	-	-	-	-	-
A Colonial	5/8" x 3-1/2"	7'6"	-	-	Z51	-	-	-
A Colonial	5/8" x 3-1/2"	8'6"	-	KKD	-	-	-	-
A Colonial	5/8" x 3-1/2"	9'	-	-	-	-	1T5	-
A Colonial	5/8" x 3-1/2"	10'	-	-	-	-	-	EAH
A Colonial	5/8" x 3-1/2"	17'	-	7JH	6NG	-	-	-
A Colonial	5/8" x 3-1/2"	RL	6J9	-	-	-	-	-
C-11	1-1/16" x 3-1/2"	17'	-	7GM	-	-	-	-
C-11	1-1/16" x 3-1/2"	RL	6D4	-	-	-	-	-
C-100	5/8" x 2-1/4"	7'	-	-	CP9	-	-	-
C-100	5/8" x 2-1/4"	14'	-	-	C10	-	-	-
C-100 (Set)	5/8" x 2-1/4"	3-0	-	-	Z40	-	-	-
C-195	9/16" x 2-1/2"	7'	-	-	C7P	-	-	-
C-195	9/16" x 2-1/2"	14'2"	-	-	6S6	-	-	-
C-195	9/16" x 2-1/2"	16'	-	113	-	-	-	-
C-195	9/16" x 2-1/2"	RL	ZW2	-	-	-	-	-
C-196	1-1/8" x 3-9/16"	17'	-	9C3	-	-	-	-
C-196	1-1/8" x 3-9/16"	RL	9H5	-	-	-	-	-
C-211	5/8" x 2-1/2"	14'2"	-	6LQ	Z95	-	-	-
C-211	5/8" x 2-1/2"	7'1"	-	13M	CFP	-	-	-
C-211	5/8" x 2-1/2"	8'6"	-	13Q	-	-	-	-
C-211	5/8" x 2-1/2"	RL	6M7	-	-	-	-	-
C-22	1-1/16" x 4"	17'	-	-	15T	-	-	-
C-295	9/16" x 3-1/2"	8'6"	-	C29	-	-	-	-
C-295	9/16" x 3-1/2"	17'	-	214	6S4	-	-	-

DOOR & WINDOW CASING



ITEM	SIZE	L	SOLID PINE	FJ	PRIMED FJ	MDF	FLEX	KNOTTY ALDER
C-295	9/16" x 3-1/2"	RL	ZW1	-	-	-	-	-
C-322	5/8" x 2-1/2"	14'2"	-	6KY	6NE	-	-	-
C-322	5/8" x 2-1/2"	7'1"	-	1S3	6SR	-	-	-
C-322	5/8" x 2-1/2"	9'	-	-	-	-	OAG	-
C-322	5/8" x 2-1/2"	RL	6KX	-	-	-	-	-
C-329	5/8" x 2-1/4"	7'	-	-	Z41	-	-	-
C-329 (Set)	5/8" x 2-1/4"	3-0	-	-	Z42	-	-	-
C-346	5/8" x 2-1/4"	7'	-	-	C24	-	-	-
C-346	5/8" x 2-1/4"	8'6"	-	-	C20	-	-	-
C-346	5/8" x 2-1/4"	12'	-	-	-	-	C15	-
C-346	5/8" x 2-1/4"	17'	-	-	C11	-	-	-
C-347	5/8" x 3-1/2"	8'6"	-	-	CFZ	-	-	-
C-347	5/8" x 3-1/2"	17'	-	2GB	6S5	-	-	-
C-522	9/16" x 3-1/2"	17'	-	8LS	6S3	-	-	-
C-522	9/16" x 3-1/2"	8'6"	-	OCX	6SS	-	-	-
C-522	9/16" x 3-1/2"	9'	-	-	-	-	OAH	-
C-522	9/16" x 3-1/2"	RL	6M9	-	-	-	-	-
Cove Casing	5/8" x 2-1/4"	14'	-	9WA	-	-	-	-
E Casing	5/8" x 2-1/2"	7'	-	-	Z38	-	-	-
E Casing	5/8" x 2-1/4"	14'	-	UIG	-	-	-	-
E Casing	5/8" x 2-1/4"	RL	UIF	-	-	-	-	-
E Casing	9/16" x 2-1/2"	14'2"	-	6JI	-	-	-	-
E Casing	9/16" x 2-1/2"	7'1"	T07	-	Z43	-	-	-
	T06	-	-	-	-	-	-	-
E Casing	9/16" x 2-1/2"	RL	6DS	-	-	-	-	-
Fluted	11/16" x 3-3/8"	15'	-	6JY	-	-	-	-
Fluted	11/16" x 3-3/8"	RL	6J3	-	-	-	-	-
Fluted	5/8" x 5-1/4"	16'	-	6JZ	-	-	-	-
H Wedge	5/8" x 2-1/8"	7'	6FJ	6FW	6GQ	-	-	-
H Wedge	5/8" x 2-1/8"	14'	-	6GO	-	-	-	-
H Wedge	5/8" x 2-1/8"	RL	14G	-	-	-	-	-
H Wedge (Set)	5/8" x 2-1/8"	3-0	Z16	-	Z35	-	-	-
LA314	13/16" x 3-1/4"	17'	-	-	LA3	-	-	-
LC-11	5/8" x 3-1/2"	7'6"	-	-	Z43	-	-	-
LC-11	5/8" x 3-1/2"	8'6"	-	OCY	-	-	-	-
LC-11	5/8" x 3-1/2"	9'	-	-	-	-	OAI	-
LC-11	5/8" x 3-1/2"	17'	-	7GL	6NO	Z22	-	-
LC-11	5/8" x 3-1/2"	RL	6D6	-	-	-	-	-

ITEM	SIZE	L	SOLID PINE	FJ	PRIMED FJ	MDF	FLEX	KNOTTY ALDER
Mixon	5/8" x 2-1/8"	RL	6DB	-	-	-	-	-
SLC-312	17mm x 3-1/2"	17'	-	-	-	4AT	-	-
SLC-312	9/16" x 3-1/2"	8'6"	-	-	Z61	-	-	-
SLC-312	9/16" x 3-1/2"	17'	-	-	6S0	-	-	-
SLCD-312 w/ Dado	17mm x 3-1/2"	17'	-	-	-	4AS	-	-
SLCD-312 w/ Dado	9/16" x 3-1/2"	17'	-	-	DDG	-	-	-
Step	5/8" x 2-1/4"	RL	6DM	-	-	-	-	-
ULDW-107	20mm x 3-1/2"	16'	-	-	-	4AL	-	-
WM-306	11/16" x 2-1/4"	14'	-	13Y	-	-	-	-
WM-306	11/16" x 2-1/4"	RL	13W	-	-	-	-	-
WM-329	11/16" x 2-1/4"	RL	6J8	-	-	-	-	-
WM-356	15mm x 2-1/4"	16'	-	-	-	Z81	-	-
WM-356	5/8" x 2-1/4"	14'2"	-	6Jg	9H4	-	-	-
WM-356	5/8" x 2-1/4"	7'	6FP	6FZ	6SV	-	-	-
WM-356	5/8" x 2-1/4"	RL	6J7	-	-	-	-	-
WM-356 (Set)	5/8" x 2-1/4"	3-0	Z15	-	Z34	-	-	-
WM-473	5/8" x 2-1/4"	7'1"	-	-	Z59	-	-	-
WM-473	5/8" x 2-1/4"	14'2"	-	-	Z60	-	-	-



L8540



8540



8541

DOOR STOP

ITEM	SIZE	L	SOLID PINE	FJ	PRIMED FJ
8540	7/16" x 1-1/8"	7'	6ER	-	-
8540	7/16" x 1-1/8"	RL	6CN	-	-
8541	7/16" x 1-3/8"	7'	6EP	6G8	7PU
8541	7/16" x 1-3/8"	8'	KKB	KKA	7PT
8541	7/16" x 1-3/8"	10'	6EQ	-	-
8541	7/16" x 1-3/8"	14'	-	6E4	-
8541	7/16" x 1-3/8"	RL	6CO	-	-
L8540 (R2E)	3/8" x 1-1/8"	7'	-	6EO	-
L8540	7/16" x 1-1/8"	7'	-	-	6SN



0238 WEATHERSTRIP

GARAGE STOP

ITEM	SIZE	L	PVC
0238 WEATHERSTRIP	7/8" X 2"	7'	P27



8096



OG

OG STOP

ITEM	SIZE	L	SOLID PINE	FJ	PRIMED FJ
8096	7/16" x 1-3/8"	7'	6EE	6G9	Z27
8096	7/16" x 1-3/8"	14'	-	6II	-
8096	7/16" x 1-3/8"	RL	6BX	-	-
OG	3/8" x 1-3/8"	8'	1BE	-	-



SIDELITE STOP

SIDELITE STOP

ITEM	SIZE	L	FJ
Sidelite Stop	7/16" x 7/16"	9'	12C



8570

GLASS BEAD

ITEM	SIZE	L	SOLID PINE
8570	1/2" X 9/16"	RL	6CP



1/2 MULL



O/S MULL

MULL COVER

ITEM	SIZE	L	SOLID PINE
1/2 MULL COVER	3/8" X 1-1/4"	8'	6MG
O/S MULL COVER	1/2" X 2"	9'	6MH



EXTERIOR KERF



WM-1310



WM-1315

T-ASTRAGAL

ITEM	SIZE	L	SOLID PINE	KA	MAHOG
Exterior Kerf (Ext Prep)	1-3/4" x 3-1/4"	8'	GOE	-	-
Exterior Kerf (Ext Prep)	2-7/8" x 1-3/4"	6'8"	-	-	OK1
Exterior Kerf (Ext Prep)	2-7/8" X 1-3/4"	8'	-	-	OK2
Exterior Kerf	1-3/4" x 3-1/4"	6'8"	7Y9	-	-
Exterior Kerf	1-3/4" x 3-1/4"	8'	1F3	-	-
WM-1310	1-1/4" x 2-1/4"	7'	6KJ	-	-
WM-1310	1-1/4" x 2-1/4"	8'	6KK	EAN	-
WM-1315	1-1/4" x 2"	7'	6KH	-	-
WM-1315	1-1/4" x 2"	8'	6KI	-	-

DOOR & WINDOW

WATER TABLE, WINDOW STOOL



8284

WATER TABLE

ITEM	SIZE	L	SOLID PINE
8284	1-1/16" X 2"	RL	6CH



WM-1021



WM-1163

WINDOW STOOL

ITEM	SIZE	L	SOLID PINE	FJ	PRIMED FJ	MDF
WM-1021	11/16" x 5-1/4"	8'	-	-	Z32	-
WM-1021	11/16" x 5-1/4"	16'	-	6GR	S99	-
WM-1021	11/16" x 5-1/4"	RL	6DW	-	-	-
WM-1021	18mm x 5-1/4"	16'	-	-	-	MCE
WM-1021	11/16" x 6-1/4"	16'	-	6GS	19Y	-
WM-1021	11/16" x 6-1/4"	RL	6DX	-	-	-
WM-1021	18mm x 6-1/4"	16'	-	-	-	6LN
WM-1021	11/16" x 7-1/4"	16'	-	6GT	Z96	-
WM-1021	11/16" x 7-1/4"	RL	6DY	-	-	-
WM-1021	11/16" x 8-1/4"	16'	-	DDE	19Z	-
WM-1163	1-1/16" x 3-1/4"	RL	6CC	-	-	-



8667

BATTEN STRIP

ITEM	SIZE	L	SOLID PINE
8667	9/16" X 2-1/4"	RL	6CY



CM-12

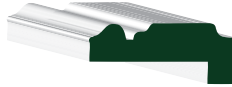

CM-20

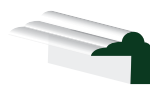

DECOR 2

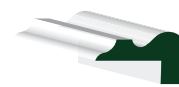

DECOR 3

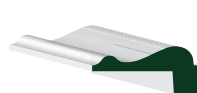

DECOR 4



DECOR 6



SHAKER LIP

LIP MOULD

ITEM	SIZE	L	SOLID PINE	FJ	PRIMED FJ
CM-12	11/16" x 2"	16'	-	6G2	-
CM-12	11/16" x 2"	RL	6F5	-	-
CM-20	7/8" x 2-1/4"	RL	SPY	-	-
Decor-2	3/4" x 1"	8'	6F7	-	-
Decor-2	3/4" x 1"	RL	6H6	-	-
Decor-3	3/4" x 1-3/8"	8'	6F8	-	-
Decor-3	3/4" x 1-3/8"	RL	6H7	-	-
Decor-4	11/16" x 1-5/8"	8'	6F9	-	-
Decor-4	11/16" x 1-5/8"	RL	6H8	-	-
Decor-6	1" x 1-5/8"	16'	-	-	17C
Decor-6	1" x 1-5/8"	RL	6H9	-	-
Shaker Lip	3/4" x 2"	16'	SPR	SPE	-

WALL & CABINET

PANEL MOULD



8174



F MOULD



K MOULD



LWM-134



PM-1



PM-7



PM-2



PM-6



PM-3



PM-5

PANEL MOULD

ITEM	SIZE	L	SOLID PINE	FJ	PRIMED FJ	FLEX
8174	11/16" X 1-5/8"	RL	6C6	-	-	-
F MOULD	5/8" X 1-1/2"	16'	-	-	6SE	-
K-MOULD	11/16" X 1-1/4"	8'	6F6	-	-	-
K-MOULD	11/16" X 1-1/4"	12'	-	-	-	OCD
K-MOULD	11/16" X 1-1/4"	16'	-	6LY	-	-
K-MOULD	11/16" X 1-1/4"	RL	6GZ	-	-	-
LWM-134	11/16" X 1-1/2"	16'	-	6LV	-	-
LWM-134	11/16" X 1-1/2"	RL	6HK	-	-	-
PM-1	11/16" X 1-5/16"	16'	-	6M4	-	-
PM-1	11/16" X 1-5/16"	RL	6DC	-	-	-
PM-2	11/16" X 1-3/4"	RL	6DD	-	-	-
PM-3	7/8" X 1-7/8"	RL	6DE	-	-	-
PM-5	11/16" X 1-1/8"	12'	-	-	-	MDW
PM-5	11/16" X 1-1/8"	16'	-	6LX	-	-
PM-5	11/16" X 1-1/8"	RL	6MC	-	-	-
PM-6	11/16" X 2"	12'	-	-	-	MDX
PM-6	11/16" X 2"	16'	-	6DG	-	-
PM-6	11/16" X 2"	RL	6DF	-	-	-
PM-7	11/16" X 1-5/16"	8'	6F3	-	-	-
PM-7	11/16" X 1-5/16"	12'	-	-	-	MDY
PM-7	11/16" X 1-5/16"	16'	-	6DI	-	-
PM-7	11/16" X 1-5/16"	RL	6DH	-	-	-



8656

PANEL STRIP

ITEM	SIZE	L	SOLID PINE
8656	3/8" X 2-1/4"	8'	6EW
8656	3/8" X 2-1/4"	RL	6CX



8263



8264

PICTURE MOULD

ITEM	SIZE	L	SOLID PINE
8263	9/16" X 1-3/4"	RL	6CA
8264	9/16" X 1-3/4"	RL	6CB



CR-5



CR-6



CR-7



WM-390

CHAIR RAIL

ITEM	SIZE	L	SOLID PINE	FJ	PRIMED FJ	FLEX
CR-5	11/16" X 2-1/2"	16'	-	6IT	-	-
CR-5	11/16" X 2-1/2"	RL	6HE	-	-	-
CR-6	1-1/4" X 3-1/4"	12'	-	-	-	OEQ
CR-6	1-1/4" X 3-1/4"	RL	6HD	-	15Z	-
CR-7	1-3/16" X 2-1/2"	16'	-	-	16F	-
CR-7	1-3/16" X 2-1/2"	RL	6HC	-	-	-
WM-390	11/16" X 2-5/8"	RL	6HG	-	-	-

WALL & CABINET

HAND RAIL



6010



6040



N-6210



WM-230

HAND RAIL

ITEM	SIZE	L	SOLID PINE	POPLAR	OAK
6010	2-1/4" x 2-3/8"	16'	-	-	Z90
6040	1-3/4" x 1-5/8"	16'	-	Z92	Z91
N-6210 (Non-Plowed)	2-5/8" x 2-3/8"	16'	-	-	Z93
WM-230	1-1/2" x 1-11/16"	16'	C12	-	-
WM-230	1-1/2" x 1-11/16"	RL	6B3	-	-

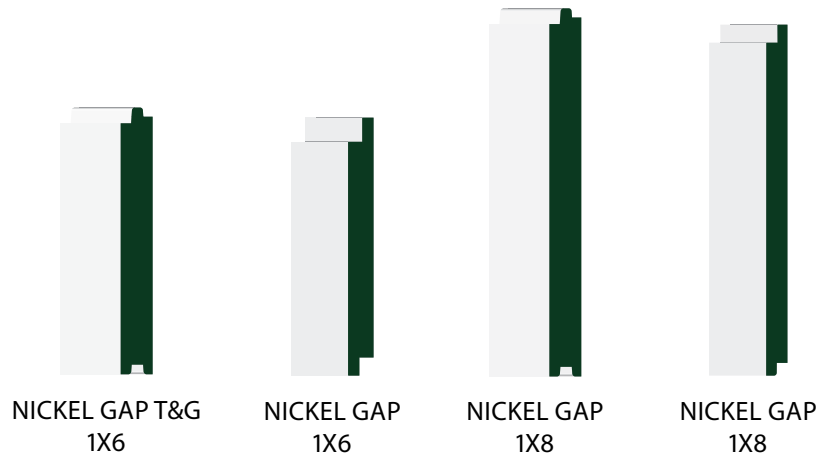

NICKEL GAP - SIMPLE & CLEAN

ITEM	SIZE	REVEAL	L	PRIMED FJ	MDF
1x6x16 Nickel Gap	9/16" x 5-3/8"	5"	16'	SPT	-
1x8x16 Nickel Gap	9/16" x 7-3/8"	7"	16'	SPO	-
1x8x12 Nickel Gap	12mm x 7-5/16" (Drywall Application)	7"	12'	-	AZN
1x6x16 Nickel Gap T&G	17mm x 5-1/4" (Stud Application)	5"	16'	-	PL8
1x8x16 Nickel Gap T&G	17mm x 7-1/4" (Stud Application)	7"	16'	-	AZM
1x6x8 Shiplap Nickel Gap	9/16" x 5-3/8"	5"	8'	SH6	-
1x8x8 Shiplap Nickel Gap	5/8" x 7-5/16"	7"	8'	SH8	-



BC/122

BEADED CEILING

ITEM	SIZE	L	PRIMED FJ
BC122FJP	3/4" X 5-3/8"	16'	SPK

FLOOR BASE

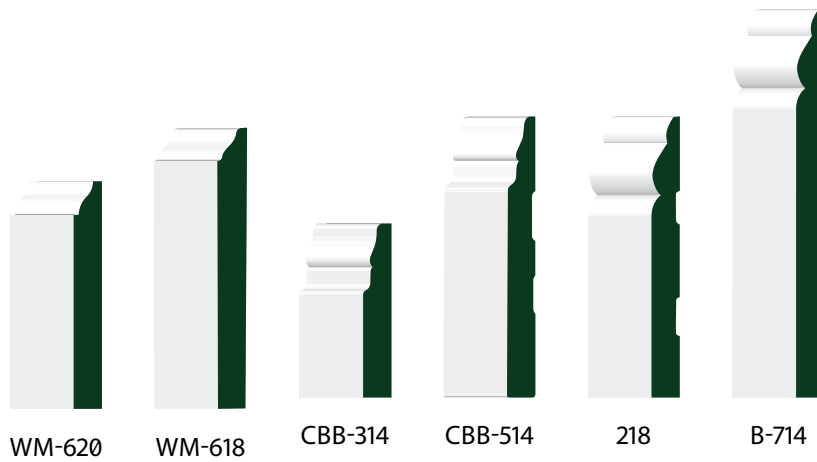
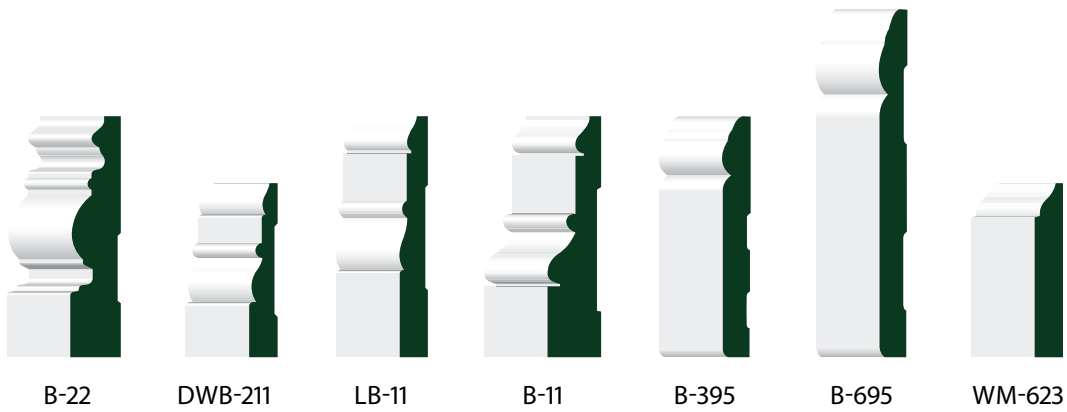
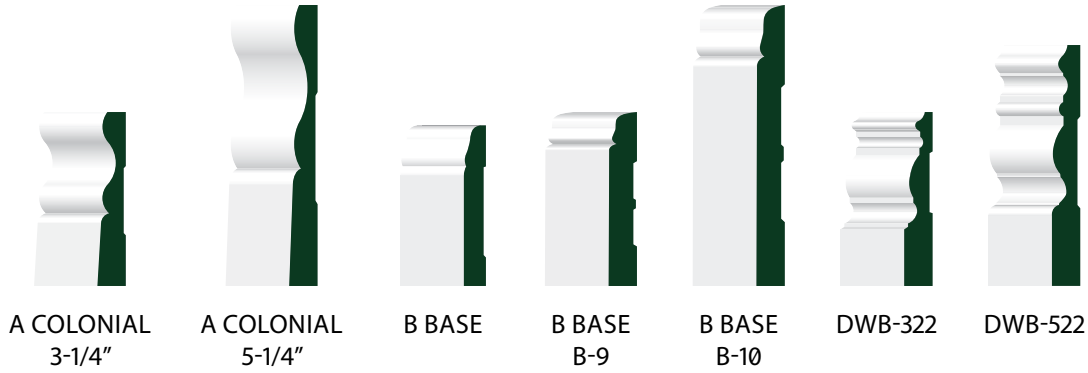

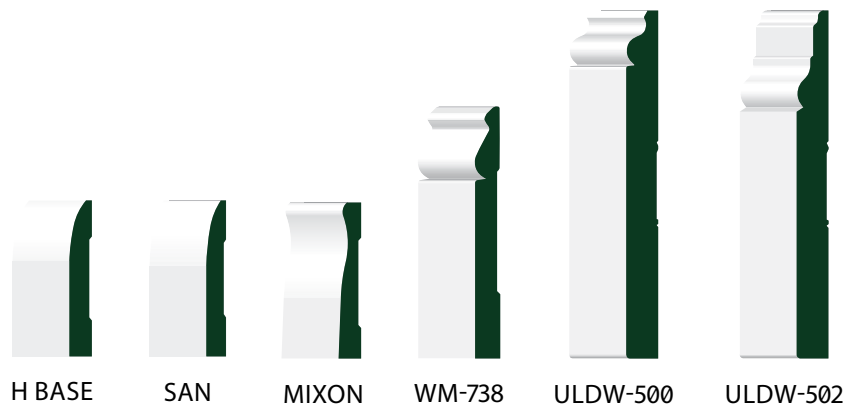
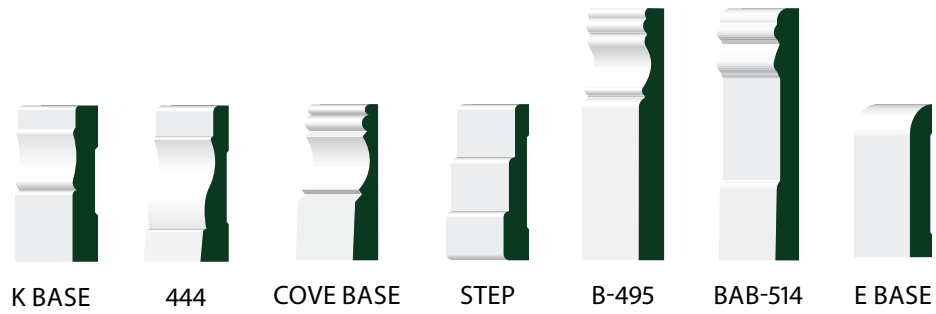
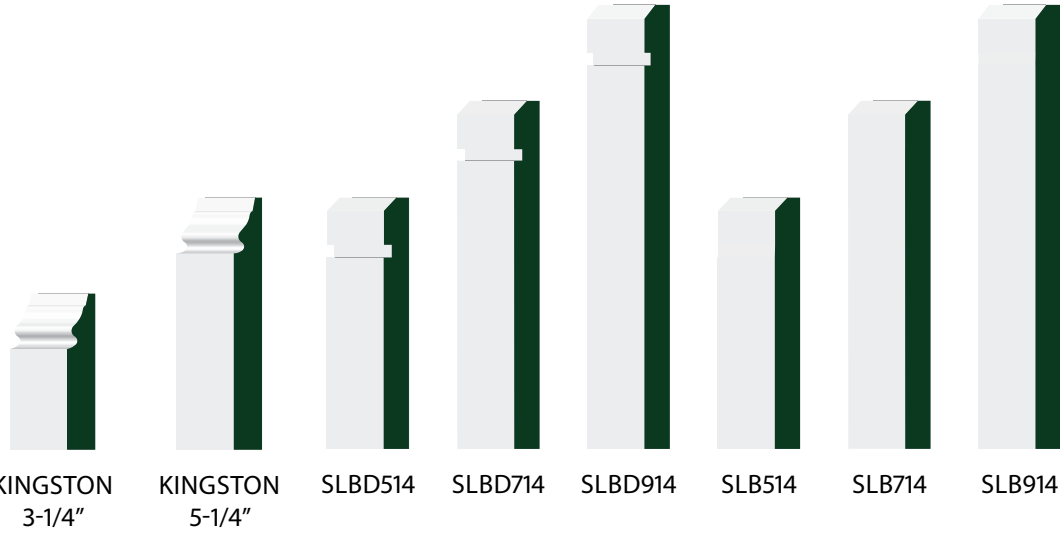

BASE

ITEM	SIZE	L	SOLID PINE	FJ	PRIMED FJ	MDF	FLEX
218	15mm x 5-1/4"	16'	-	-	-	11I	-
218	9/16" x 5-1/4"	16'	-	YA4	6S1	Z54	-
444	5/8" x 3-1/4"	16'	-	-	6JV	-	-
444	5/8" x 3-1/4"	RL	6JN	-	-	-	-
218	12mm x 5-1/4"	16'	-	-	-	KAP	-
A Colonial	14mm x 3-1/4"	16'	-	-	-	35F	-
A Colonial	9/16" x 3-1/4"	8'	S87	-	Z44	-	-
A Colonial	9/16" x 3-1/4"	12'	-	-	Z45	-	MDO
A Colonial	9/16" x 3-1/4"	16'	-	6GC	6GE	-	-
A Colonial	9/16" x 3-1/4"	RL	6DP	-	-	-	-
A Colonial	1/2" x 5-1/4"	16'	-	-	ZAX	-	-
A Colonial	9/16" x 5-1/4"	12'	-	-	-	-	C57
A Colonial	9/16" x 5-1/4"	16'	-	1ZP	-	-	-
B Base	7/16" x 3"	8'	-	-	14E	-	-
B Base	7/16" x 3"	12'	-	-	14F	-	-
B Base	7/16" x 3"	16'	-	6JT	15Q	-	-
B Base (B-10)	1/2" x 5-1/4"	12'	-	-	-	-	OEP
B Base (B-10)	1/2" x 5-1/4"	16'	-	6JX	9H2	-	-
B Base (B-10)	1/2" x 5-1/4"	RL	6JP	-	-	-	-
B Base (B-10)	12mm x 5-1/4"	16'	-	-	-	U10	-
B Base (B-9)	9/16" x 3-1/4"	12'	-	-	-	-	1T4
B Base (B-9)	9/16" x 3-1/4"	16'	-	6JW	9H1	MD2	-
B Base (B-9)	9/16" x 3-1/4"	RL	6JO	-	-	-	-
B-11	1-1/16" x 4-1/2"	12'	-	-	-	-	MDU
B-11	1-1/16" x 4-1/2"	16'	-	6GJ	-	-	-
B-11	1-1/16" x 4-1/2"	RL	6CZ	-	-	-	-
B-214	9/16" x 2-1/4"	12'	-	-	-	-	C17
B-214	9/16" x 2-1/4"	16'	-	-	C14	-	-
B-22	1" x 4-7/8"	12'	-	-	-	-	MDT
B-22	1" x 4-7/8"	16'	-	6ML	-	-	-
B-395	9/16" x 4-1/2"	12'	-	-	Z67	-	-
B-395	9/16" x 4-1/2"	16'	-	115	Z20	-	-
B-395	9/16" x 4-1/2"	RL	ZW5	-	-	-	-
B-495	9/16" x 5-1/4"	12'	-	-	Z68	-	-
B-495	9/16" x 5-1/4"	16'	-	118	Z21	-	-
B-618	9/16" x 5-1/4"	12'	-	-	-	-	C18
B-623	9/16" x 3-1/4"	12'	-	-	-	-	C16
B-695	9/16" x 6-1/2"	16'	-	-	14X	-	-

BASE

ITEM	SIZE	L	SOLID PINE	FJ	PRIMED FJ	MDF	FLEX
B-714	16mm x 7-1/4"	16'	-	-	-	9G1	-
BAB-514	9/16" x 5-1/4"	16'	-	SPQ	14Y	-	-
CBB-314	9/16" x 3-1/4"	16'	-	9C4	Z94	-	-
CBB-514	9/16" x 5-1/4"	16'	-	CA2	ZYY	-	KL4
Cove Base	5/8" x 3-1/4"	16'	-	9WB	-	-	-
Cove Base	5/8" x 3-1/4"	RL	6B2	-	-	-	-
DWB-211	9/16" x 3-1/4"	16'	-	6LR	-	-	-
DWB-211	9/16" x 3-1/4"	RL	6M8	-	-	-	-
DWB-322	16mm x 3-1/4"	16'	-	-	-	9G2	-
DWB-322	9/16" x 3-1/4"	12'	-	-	Z49	Z53	MDQ
DWB-322	9/16" x 3-1/4"	16'	-	6L3	6S2	-	-
DWB-322	9/16" x 3-1/4"	RL	6KZ	-	-	-	-
DWB-522	9/16" x 4-1/2"	12'	-	-	-	-	MDR
DWB-522	9/16" x 4-1/2"	16'	-	6LT	-	-	-
DWB-522	9/16" x 4-1/2"	RL	6MA	-	-	-	-
E Base	1/2" x 3-1/2"	RL	6DR	-	-	-	-
E Base	5/8" x 3-1/2"	16'	-	9C6	-	-	-
H Base	1/2" x 3-1/4"	16'	-	6GN	-	-	-
H Base	1/2" x 3-1/4"	RL	6DT	-	-	-	-
K Base	9/16" x 3-1/4"	16'	-	6JU	-	-	-
K Base	9/16" x 3-1/4"	RL	6JM	-	-	-	-
Kingston	5/8" x 3-1/4"	16'	-	W13	-	-	-
Kingston	5/8" x 5-1/4"	16'	-	W15	-	-	-
LB-11	5/8" x 4-1/2"	16'	-	-	-	Z57	-
LB-11	9/16" x 4-1/2"	12'	-	-	Z48	-	MDS
LB-11	9/16" x 4-1/2"	16'	-	6GG	9H3	-	-
LB-11	9/16" x 4-1/2"	RL	6D3	-	-	-	-
LWM-444	5/8" x 3-1/4"	16'	-	-	-	444	-
Mixon	1/2" x 3-1/4"	RL	6DA	-	-	-	-
San	7/16" x 3"	8'	6FQ	-	6JB	-	-
San	7/16" x 3"	12'	-	-	Z46	-	-
San	7/16" x 3"	16'	-	6JR	-	-	-
San	7/16" x 3"	RL	6JJ	-	-	-	-
San	7/16" x 3-1/4"	16'	-	6JS	-	-	-

BASE

ITEM	SIZE	L	SOLID PINE	FJ	PRIMED FJ	MDF	FLEX
San	7/16" x 3-1/4"	RL	6JK	-	-	-	-
SLB-514	15mm x 5-1/4"	16'	-	-	-	4AV	-
SLB-514	9/16" x 5-1/4"	12'	-	-	Z62	-	-
SLB-514	9/16" x 5-1/4"	16'	-	-	6SA	-	-
SLB-714	9/16" x 7-1/4"	12'	-	-	Z63	-	-
SLB-714	9/16" x 7-1/4"	16'	-	-	6SB	-	-
SLB-914	9/16" x 9-1/4"	16'	-	-	6SC	-	-
SLBD-514 w/ Dado	15mm x 5-1/4"	16'	-	-	-	4AU	-
SLBD-514 w/ Dado	9/16" x 5-1/4"	16'	-	-	SP1	-	-
SLBD-714 w/ Dado	9/16" x 7-1/4"	16'	-	-	SPC	-	-
SLBD-914 w/ Dado	9/16" x 9-1/4"	16'	-	-	SPD	-	-
Step	9/16" x 3-1/4"	16'	-	9C7	-	-	-
Step	9/16" x 3-1/4"	RL	6DL	-	-	-	-
ULDW-500	18mm x 7-1/4"	16'	-	-	-	4AE	-
ULDW-502	18mm x 7-1/4"	16'	-	-	-	4AF	-
WM-618	15mm x 5-1/4"	16'	-	-	-	9G5	-
WM-618	9/16" x 5-1/4"	16'	-	-	6S8	-	-
WM-620	9/16" x 4-1/4"	16'	-	-	14R	-	-
WM-623	15mm x 3-1/4"	16'	-	-	-	9G6	-
WM-623	9/16" x 3/4"	8'	-	-	Z47	-	-
WM-623	9/16" x 3-1/4"	16'	-	-	6S7	-	-
WM-738	9/16" x 5-1/4"	16'	-	-	11O	-	-



WM-163

BASE CAP

ITEM	SIZE	L	SOLID PINE	PRIMED FJ
WM-163	11/16" X 1-3/8"	8'	-	Z69
WM-163	11/16" X 1-3/8"	16'	-	6SD
WM-163	11/16" X 1-3/8"	RL	6GX	-



8422

BASE SHOE

ITEM	SIZE	L	SOLID PINE	FJ	PRIMED FJ	FLEX	OAK	KA
8422	7/16" X 3/4"	8'	6EL	-	6IP	-	69S	-
8422	7/16" X 3/4"	12'	Z12	-	Z26	OAA	-	-
8422 (OAK GRAIN)	7/16" X 3/4"	12'	-	-	-	2A7	-	-
8422	7/16" X 3/4"	16'	Z13	6IM	6IO	-	-	-
8422	7/16" X 3/4"	RL	6CJ	-	-	-	68W	KB2

GENERAL PURPOSE

CHAMFER STRIP, INSIDE & OUTSIDE CORNERS



WM-995

CHAMFER STRIP

ITEM	SIZE	L	SOLID PINE
WM-995	3/4" X 3/4"	8'	S75
WM-995	3/4" X 3/4"	RL	6D7



LWM-999



WM-999



8200



8238



820034



DW-203

INSIDE & OUTSIDE CORNERS

ITEM	SIZE	L	SOLID PINE	FLEX
8200	1" X 1"	8'	6EG	-
8200	1" X 1"	12'	-	2A6
8200	1" X 1"	RL	6C8	-
8238	1-1/4" X 1-1/4"	8'	6EH	-
8238	1-1/4" X 1-1/4"	RL	6C9	-
820034	3/4" X 3/4"	8'	6EF	-
DW-203	1-3/8" X 1-3/8"	RL	OPJ	-
LWM-999	3/4" X 3/4"	8'	6EX	-
WM-999	5/16" X 1"	8'	6EY	-

GENERAL PURPOSE

LATTICE, NOSING, SCREEN MOULD

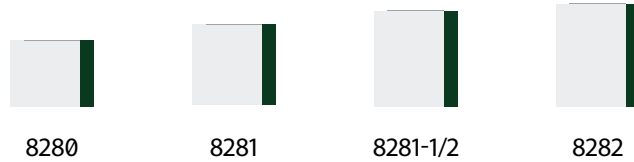

LATTICE

ITEM	SIZE	L	SOLID PINE
8280	1/4" X 1-1/8"	8'	6EI
8280	1/4" X 1-1/8"	RL	6CD
8281	1/4" X 1-3/8"	8'	6EJ
8281	1/4" X 1-3/8"	RL	6CE
8282	1/4" X 1-3/4"	8'	6EK
8282	1/4" X 1-3/4"	RL	6CG
8281-1/2	1/4" X 1-5/8"	RL	6CF



NOSING

ITEM	SIZE	L	SOLID PINE
8132	9/16" X 7/8"	RL	6BZ
8619	1/2" X 3/4"	RL	6CV

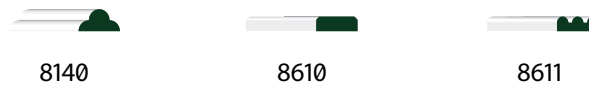

SCREEN MOULD

ITEM	SIZE	L	SOLID PINE	OAK	KA
8140	3/8" X 3/4"	8'	6LB	-	-
8140	3/8" X 3/4"	RL	6C3	-	-
8610	1/4" X 3/4"	8'	6ET	KB4	KB5
8610	1/4" X 3/4"	RL	6CQ	-	KB3
8611	1/4" X 3/4"	8'	6LC	-	-
8611	1/4" X 3/4"	RL	6CR	-	-



8912

ROUND - FULL

ITEM	SIZE	L	YELLOW PINE	FIR	LVL
89128	1-5/16"	8'	-	6FF	-
89128	1-1/4"	8'	-	6FF	Z14
8912	1-5/16"	RL	6K9	-	-
8912	1-1/4"	12'	-	-	Z19
8912	1-1/4"	16'	-	-	6K7



8078

8080

ROUND - HALF

ITEM	SIZE	L	SOLID PINE
8078	1/2" X 1"	RL	6BU
8080	11/16" X 1-1/2"	RL	6BW



8057

8063

8065

ROUND - QUARTER

ITEM	SIZE	L	SOLID PINE	PRIMED FJ	OAK	PVC
8057	1/4" X 1/4"	8'	6E8	-	-	-
8063	1/2" X 1/2"	8'	6EB	-	-	-
8063	1/2" X 1/2"	RL	6BP	-	-	-
8065	3/4" X 3/4"	8'	T5R	6NP	KB8	P25
8065	3/4" X 3/4"	12'	Z11	Z25	-	-
8065	3/4" X 3/4"	16'	Z18	6NA	-	-
8065	3/4" X 3/4"	RL	6BQ	-	67W	-

PRIMED FINGER-JOINT BOARDS



10
YEAR

WARRANTY

* Warranty subject to terms, conditions, and limitations.

The Advantages of Choosing SBP Primed Finger-Joint Boards

- ✓ **Unmatched Availability, Reliable Consistency, and Exceptional Value.**
- ✓ **Industry's Preferred Pine Substrate.**
94% of industry experts favor Pine over alternatives.
- ✓ **Built to Last.**
Exterior grade glue in both primer and substrate joints for durability.
- ✓ **Premium Finish.**
Exceeds industry standards with a multi-layer primer coat for durability and aesthetics.
- ✓ **Precision Primer.**
Avoids chip-out and minimizes installation defects.



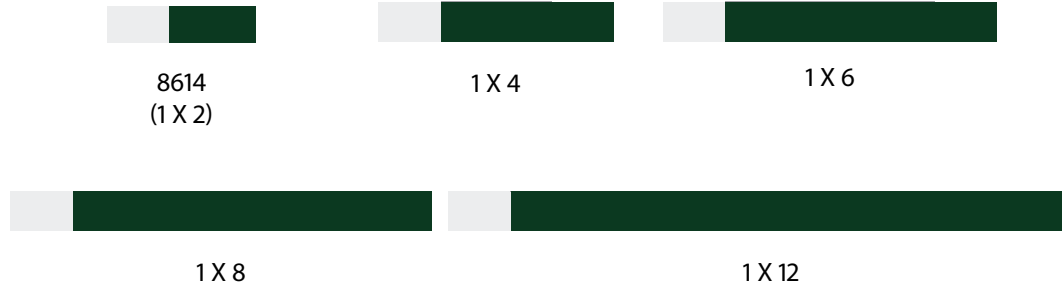

S4S

ITEM	SIZE	L	SOLID PINE	FJ	PRIMED FJ	FLEX	FRAME SAVER
8614	11/16" x 1-3/4"	8'	6EU	T5S	Z28	-	-
8614	11/16" x 1-3/4"	12'	-	-	-	OAD	-
8614	11/16" x 1-3/4"	16'	-	6IQ	9G8	-	-
1 x 2	11/16" x 1-1/2"	16'	-	-	SS2	-	-
1 x 3	9/16" x 2-1/2"	17'	-	-	33h	-	-
1 x 3	11/16" x 2-1/2"	17'	-	-	16G	-	-
1 x 4	9/16" x 3-1/2"	17'	-	-	16H	-	-
1 x 4	11/16" x 3-1/2"	7'	-	-	-	-	11E
1 x 4	11/16" x 3-1/2"	7'1"	-	-	DF7	-	-
1 x 4	11/16" x 3-1/2"	8'6"	-	-	DF8	-	-
1 x 4	11/16" x 3-1/2"	10'	-	-	-	OAC	-
1 x 4	11/16" x 3-1/2"	17'	-	1NY	1NZ	-	-
1 x 4	11/16" x 3-1/2"	RL	6DK	-	-	-	-
1 x 6	9/16" x 5-1/2"	16'	-	-	16J	-	-
1 x 6	11/16" x 5-1/2"	16'	-	6I8	16J	-	-
1 x 6	11/16" x 5-1/2"	8'	-	-	6NY	-	-
1 x 6	11/16" x 5-1/2"	12'	-	-	-	1AP	-
1 x 6	11/16" x 5-1/2"	16'	-	-	6NK	-	-
1 x 8	11/16" x 7-1/4"	8'	-	-	ZYX	-	-
1 x 8	11/16" x 7-1/4"	16'	-	6I9	6KC	-	-
1 x 12	11/16" x 11-1/4"	16'	-	43K	S12	-	-

S4S RADIATA C+ PINE

ITEM	SIZE	L	RADIATA C+
1 X 4	3/4" X 3-1/2"	8'	RPA
1 X 4	3/4" X 3-1/2"	10'	RPB
1 X 4	3/4" X 3-1/2"	12'	RPC
1 X 4	3/4" X 3-1/2"	14'	RPF
1 X 4	3/4" X 3-1/2"	16'	RPG
1 X 6	3/4" X 5-1/2"	8'	RPI
1 X 6	3/4" X 5-1/2"	10'	RPJ
1 X 6	3/4" X 5-1/2"	12'	RPK
1 X 6	3/4" X 5-1/2"	14'	RPL
1 X 6	3/4" X 5-1/2"	16'	RPM
1 X 8	3/4" X 7-1/4"	8'	RPN
1 X 8	3/4" X 7-1/4"	10'	RPP
1 X 8	3/4" X 7-1/4"	12'	RPQ
1 X 8	3/4" X 7-1/4"	14'	RPR
1 X 8	3/4" X 7-1/4"	16'	RPS
1 X 12	3/4" X 11-1/4"	8'	RPT
1 X 12	3/4" X 11-1/4"	10'	RPU
1 X 12	3/4" X 11-1/4"	12'	RPV
1 X 12	3/4" X 11-1/4"	14'	RPW
1 X 12	3/4" X 11-1/4"	16'	RPX

S4S KNOTTY ALDER, MAPLE, OAK, POPLAR

ITEM	SIZE	L	POPLAR	OAK	KNOTTY ALDER	MAPLE
1 X 2	3/4" X 1-1/2"	8'	-	KA6	KA5	-
1 X 2	3/4" X 2"	8'6"	KB9	-	-	-
1 X 2	3/4" X 2"	RL	Z86	Z82	KB6	-
1 X 3	3/4" X 2-1/2"	8'	8CY	-	-	-
1 X 4	3/4" X 3-1/2"	RL	-	-	EAC	-
1 X 4	3/4" X 3-1/2"	8'	-	KA7	KA1	-
1 X 4	3/4" X 3-1/2"	8'6"	KC1	-	-	-
1 X 4	3/4" X 3-1/2"	RL	Z87	Z83	-	-
1 X 6	3/4" X 5-1/2"	RL	-	-	EAD	-
1 X 6	3/4" X 5-1/2"	8'	-	KA8	KA2	-
1 X 6	3/4" X 5-1/2"	8'6"	KC2	-	-	-
1 X 6	3/4" X 5-1/2"	RL	Z88	Z84	-	-
1 X 8	3/4" X 7-1/4"	8'	-	KA9	KA3	-
1 X 8	3/4" X 7-1/4"	RL	Z89	Z85	KB7	-
1 X 12	3/4" X 11-1/4"	8'	-	KB1	KA4	-
1 X 12	3/4" X 11-1/4"	RL	-	-	-	DA5

SCREEN STOCK, MDF BOARDS, PARTICLE BOARDS



S4S SCREEN STOCK

ITEM	SIZE	L	SOLID PINE
8432	1/2" X 3/4"	8'	6EM
8432	1/2" X 3/4"	RL	6CL
8614	11/16" X 1-3/4"	RL	6CS
8615	11/16" X 2-3/4"	RL	6CU
8614-1/2	11/16" X 2"	RL	6CT
S4S	1/2" X 2-1/2"	8'	6FD
S4S	1/2" X 2-1/2"	RL	6DJ

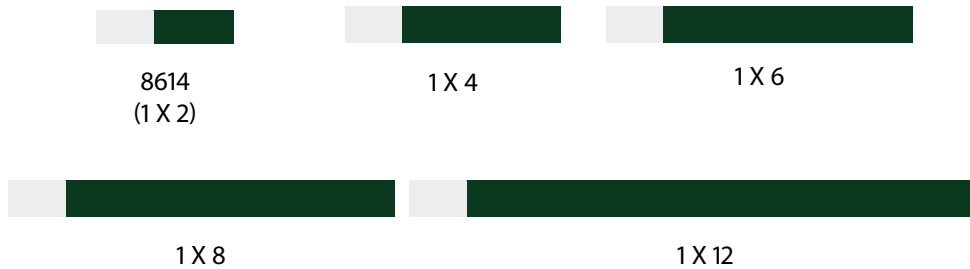

MDF BOARDS

ITEM	L	PRIMED	RAW
1 X 2	16'	Z99	DF1
1 X 4	16'	Z78	-
1 X 4	17'	-	104
1 X 6	16'	Z79	DF3
1 X 8	16'	AH4	DF4
1 X 12	16'	6PE	DF5
1 X 16	16'	6PF	-
1 X 24	16'	6PH	-



BULLNOSE PARTICLE BOARD

BULLNOSE PARTICLE BOARDS

ITEM	L	RAW
1 X 12	16'	A2H0
1 X 16	16'	A1H9



1 X 2



1 X 4



1 X 6



1 X 8



1 X 12

PRECUT S4S PRIMED FJ

ITEM	SIZE	L
1 X 2	11/16" X 1-1/2	8'
1 X 3	11/16" X 2-1/2	8'
1 X 4	11/16" X 3-1/2	8'
1 X 4	11/16" X 3-1/2	10'
1 X 6	11/16" X 5-1/2	8'
1 X 6	11/16" X 5-1/2	10'
1 X 8	11/16" X 7-1/4	10'
1 X 12	11/16" X 11-1/4	8'
1 X 12	11/16" X 11-1/4	10'



100 COVE

COVE

ITEM	SIZE	L	CRYSTAL WHITE	RIVER GREY
100	11/16" X 11/16"	8"	P08	P20



327
RANCH

350 OG



356

CASING

ITEM	SIZE	L	CRYSTAL WHITE	RIVER GREY	RUSSET
327 Ranch	5/8" x 2-1/4"	8'	-	-	ZE4
350 OG	9/16" x 2-1/8"	7'	-	P19	P14
356	11/16" x 2-3/8"	7'	P04	-	-



888

946 OG

STOP

ITEM	SIZE	L	CRYSTAL WHITE	RUSSET
888	3/8" x 1-1/8"	7'	P10	-
946 OG	3/8" x 1-5/16"	7'	ZE5	P17



633 OG

713
RANCH

BASE

ITEM	SIZE	L	CRYSTAL WHITE	RIVER GREY	RUSSET
633 OG	3/8" x 3-3/16"	8'	P03	P18	P13
713 Ranch	7/16" x 3-3/16"	8'	-	-	ZE3



292 OG

BASE CAP

ITEM	SIZE	L	CRYSTAL WHITE
292 OG	7/16" x 1-1/8"	8'	P09



109

BASE SHOE

ITEM	SIZE	L	CRYSTAL WHITE
109	9/16" x 1/4"	8'	P02

PREFINISHED MOULDING

CEILING, DOOR & WINDOW, FLOOR



INSIDE & OUTSIDE CORNERS

ITEM	SIZE	L	CRYSTAL WHITE	RIVER GREY	RUSSET
093 Inside Corner	1/4" x 7/8"	8'	P06	-	P15
205 Lg. Outside Corner	15/16" x 15/16"	8'	P07	P21	P16



093 INSIDE



205 LG OUTSIDE

QUARTER ROUND

ITEM	SIZE	L	CRYSTAL WHITE	RIVER GREY	RUSSET
107	9/16" x 9/16"	8'	P01	P22	P12



107

SCREEN TRIM

ITEM	SIZE	L	CRYSTAL WHITE	RUSSET
142	1/4" x 3/4"	8'	P05	P11



142

S4S

ITEM	SIZE	L	RIVER GREY
025 Craftsman 2-1/2"	1/2" x 2-1/2"	8'	P23
040 Craftsman 4"	1/2" x 4"	8'	P24



025



040

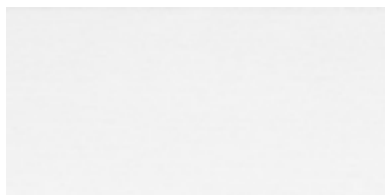

CRYSTAL WHITE



RIVER GREY
WOODGRAIN FINISH



RUSSET
WOODGRAIN FINISH

ACCESSORIES

CORNER BLOCKS, POLE SOCKETS, SHELF BRACKETS

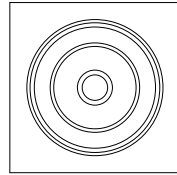

BULLSEYE



STAR

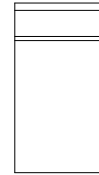

PLINTH BLOCK

CORNER BLOCKS

ITEM	SIZE	SOLID PINE	FLEX
BULLSEYE	27/32" X 3-1/2"	4G9	-
PLINTH BLOCKS	7/8" X 3-1/2" X 6-1/2"	4G4	-
STAR	3-1/2"	-	1AL



WOOD
POLE SOCKETS

POLE SOCKETS

SKU	DESCRIPTION	ITEM #
28390046	1-3/8" CLOSET POLE SOCKET WOOD	N262-972



SHELF/ROD
BRACKET FLAT
WHT

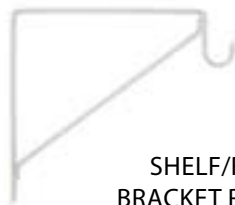

SHELF/ROD
BRACKET ROUND
HD WHT



10X12" SHELF
BRACKET WHITE



12X14" SHELF
BRACKET WHITE

SHELF BRACKETS

SKU	DESCRIPTION	ITEM #
28378152	SHELF/ROD BRACKET FLAT WHT	N224-501
28390046	SHELF/ROD BRACKET ROUND HD WHT	N224-428
28480106	10X12" SHELF BRACKET WHITE	N218-958
28480112	12X14" SHELF BRACKET WHITE	N245-779



DREAMING OF THAT NEW LOOK?

We have you covered with our new
Simple & Clean Moulding line

PATTERN STOCK

- Superior Finish
- Faster to Install
- Self Spacing
- Consistent Look

MOULDING

- Pine Substrate
- Double Pass
Premium Primer Finish
- Harvested from Sustainable
Forest
- Traditional and Trending
Profile Selection

SIMPLE & CLEAN MOULDING



SLCD-312
3-1/2"
CASING

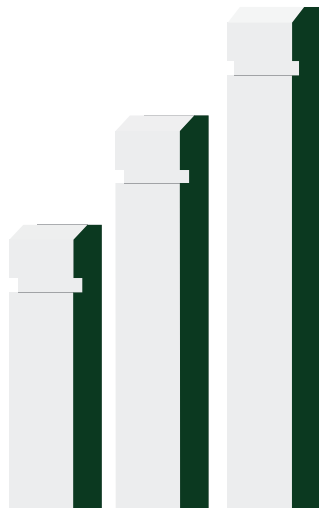

SLBD-514 SLBD-714 SLBD-914
5-1/4" 7-1/4" 9-1/4"
BASE



SLC-312
3-1/2"
CASING

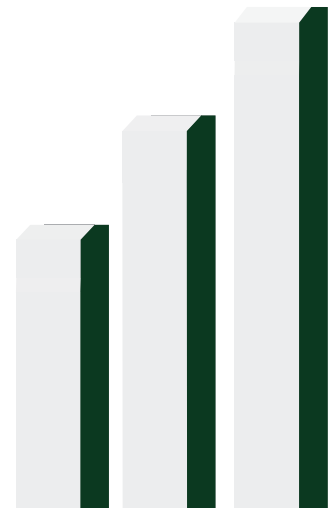

SLB-514 SLB-714 SLB-914
5-1/4" 7-1/4" 9-1/4"
BASE

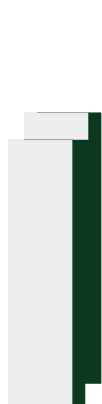

1X6
NICKEL GAP
5" REVEAL

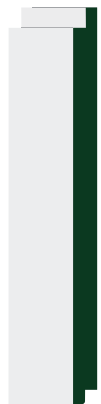

1X8
NICKEL GAP
7" REVEAL



BEADED
CEILING / 122
REVERSIBLE

PATTERN BOARDS

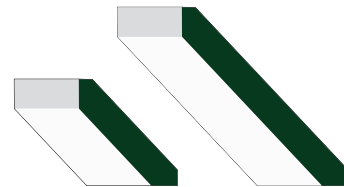

SLC234 2-3/4" SLC458 4-5/8"

CROWN

FITS IN WITH THE HOTTEST TRENDS

MODERN FARMHOUSE • TRADITIONAL • MODERN CONTEMPORARY



Round Column

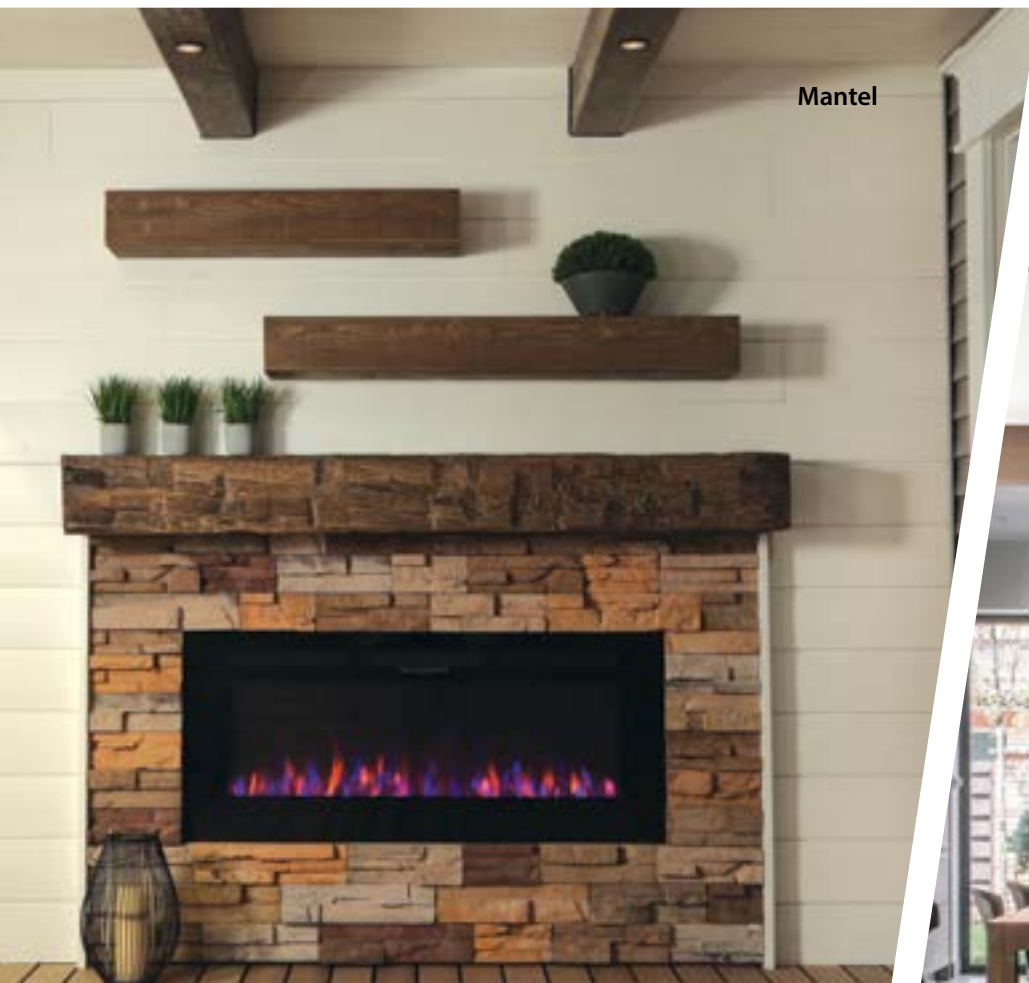

Mantel



Beams

FIBERGLASS COLUMNS

PERMACAST COLUMNS, CAPS & BASES



ROUND
SMOOTH

ROUND
NON-TAPERED

CAST PLAIN
SQUARE

PERMACAST COLUMNS

SIZE	CAST PLAIN SQUARE	ROUND NON-TAPERED	ROUND SMOOTH	TAPERED SQUARE
8 X 8	R44	R10	HG3	-
8 X 9	R51	-	HG4	-
8 X 10	R45	-	HG1	-
10 X 8	R46	-	HF3	-
10 X 9	R52	-	-	-
10 X 10	R47	-	HF1	-
12 X 10	R62	R40	HF5	-
16 X 9 X 58	-	-	-	R53

LOAD BEARING CAPACITY

SIZE	ROUND	SQUARE
6"	8,000 LBS	8,000 LBS
8"	10,500 LBS	10,500 LBS
10"	13,990 LBS	13,990 LBS
12"	18,000 LBS	18,000 LBS

FIBERGLASS CAPS & BASES

SIZE	TUSCAN POLY	TUSCAN NON-TAPERED	SQUARE CAST
8"	HG8	R13	1XD
10"	HG5	-	-
12"	HG6	R66	R71



TUSCAN
CAP & BASE

Tuscan Poly Cap & Base includes
Flashing Cap
& Column Installation Kit

DISTRIBUTED THROUGH **DW DISTRIBUTION**

BEAMS & MANTELS

WOOD-GRAINED, SMOOTH



HAND HEWN MESA ROUGH SAWN SMOOTH TAHOE



HAND HEWN
BEAM



MESA
BEAM



SMOOTH
BEAM



TAHOE
BEAM

WOOD-GRAINED BEAMS

GRAIN	SIZE	8'	12'	16'	20'
HAND HEWN	6 x 8	F12	F13	F14	-
HAND HEWN	8 x 10	F17	F18	F19	FZ1
HAND HEWN	10 x 12	-	-	FZ6	-
MESA	6 x 8	-	F02	F03	FZ3
MESA	8 x 10	-	F07	F08	-
SMOOTH	6 x 8	-	-	F34	FZ4
SMOOTH	10 x 12	-	-	FZ5	FZ8
TAHOE	6 x 8	-	F23	F24	-
TAHOE	8 x 10	-	F28	F29	FZ2
TAHOE	10 x 12	-	-	FZ7	-

INSTALLER NOTE:

6X8 BEAMS MOUNT TO 2X4 | 8X10 BEAMS MOUNT TO 2X6

DISTRIBUTED THROUGH **DW DISTRIBUTION**



HAND HEWN



ROUGH SAWN

WOOD-GRAINED BEAMS

GRAIN	SIZE	5'	6'
HAND HEWN	8 x 10	F38	F39
ROUGH SAWN	6 x 8	F36	-



HAMMERED BEAM STRAP

HAMMERED BEAM STRAPS

DESCRIPTION	SIZE	BEAM STRAPS
HAMMERED BEAM STRAP (SET OF 2)	6 x 8	F98

DISTRIBUTED THROUGH **DW DISTRIBUTION**

DECORATIVE MILLWORK

BRACKET



F82



F74



FY1



F75



FY0



F77

BRACKET

GRAIN	SIZE (H X W X L)	FYPON CODE	DW CODE
SMOOTH	7-1/4 X 12 X 4	BKT7X12X4	F82
SMOOTH	16 X 3 X 11-1/2	BKT12X16	F74
SMOOTH	18 X 10-1/8 X 7-1/4	BKT18X10	FY1
SMOOTH	18 X 18 X 3-1/2	BKT18X18X4	F75
SMOOTH	25 X 27-1/2 X 3-1/2	BKT25X27	FY0
WOOD GRAIN	14 X 16 X 3-1/2	BKT14X16X35S	F77

DISTRIBUTED THROUGH **DW DISTRIBUTION**



F95



F88
F89



FY3



FY2

CORBELS

GRAIN	SIZE (H X W X L)	FYPON CODE	DW CODE
WOOD GRAIN	5-1/2 X 5-1/2 X 3-1/2	COR5X5X3S	F95
WOOD GRAIN	8 X 8 X 6	COR8X8X6S	F88
WOOD GRAIN	11 X 11 X 5	COR11X11X5S	FY3
WOOD GRAIN	11-3/8 X 7 X 7-3/8	COR7X11S	F89
WOOD GRAIN	18 X 8 X 6	COR18X8X6S	FY2



FY4

KNEE BRACE

GRAIN	SIZE (H X W X L)	FYPON CODE	DW CODE
WOOD GRAIN	21 X 30 X 5	BKTCV21X30X6S	FY4



FZ0

RAFTER TAIL

GRAIN	SIZE (H X W X L)	FYPON CODE	DW CODE
WOOD GRAIN	3-1/2 X 5-1/2 X 18	BMRTSC4X6X18RS-4	FZ0

DISTRIBUTED THROUGH **DW DISTRIBUTION**

DECORATIVE MILLWORK

LOUVER, BOARD AND BATTEN SHUTTER



ROUND
BRICKMOULD
STYLE



VERTICAL
BRICKMOULD
STYLE

DECORATIVE & FUNCTIONAL LOUVERS

GRAIN	DESCRIPTION	SIZE (H X W X L)	FYPON CODE	DW CODE
SMOOTH	Decorative Round Brickmould Style	22 X 1-5/8	RLV22	FY7
SMOOTH	Decorative Vertical Brickmould Style	12 X 24	LV12X24	FY5
SMOOTH	Decorative Vertical Brickmould Style	18 X 36 X 1-5/8	LV18X36	FY6
SMOOTH	Decorative Vertical Brickmould Style	12 X 18	LV12X18	FY8
SMOOTH	Functional Vertical Brickmould Style	12 X 18 X 2	FLV12X18	FY9



BOARD AND BATTEN SHUTTER

GRAIN	SIZE (H X W X L)	FYPON CODE	DW CODE
WOOD GRAIN	14 X 36 X 1-1/2	SH3PC14X36RS	F09
WOOD GRAIN	14 X 48 X 1-1/2	SH3PC14X48RS	F05
WOOD GRAIN	14 X 60 X 1-1/2	SH3PC14X60RS	FZ9
WOOD GRAIN	14 X 72 X 1-1/2	SH3PC14X72RS	F04

DISTRIBUTED THROUGH **DW DISTRIBUTION**

Coffman
STAIR PARTS[®]

**STAIR
PARTS**

EASY STEPS TO CREATE A STAIRCASE

STEP BY STEP GUIDE

Designing your dream staircase is now simpler and more enjoyable with Coffman Stair Parts. No matter your personal taste or the style of your home, we make it easy to transform your vision into a stunning reality. Follow our straightforward, step-by-step guide to craft a staircase that's not just a structure, but a centerpiece of your home.

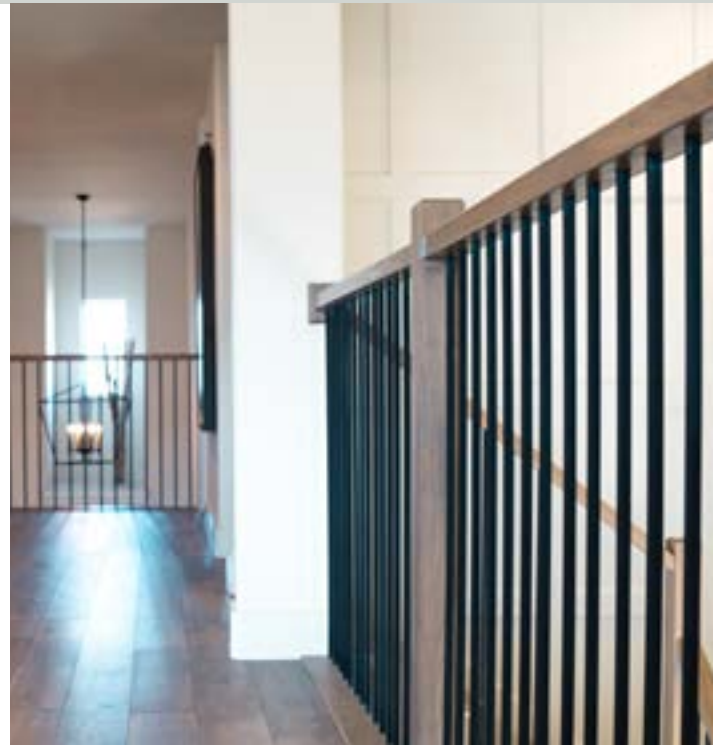

Pick Your Newel

In Over-The-Post stair designs, the handrail flows continuously over the newels and balusters, spanning the entire length of the stairway. This style allows for the incorporation of various decorative elements, enhancing the aesthetic appeal. Post-to-Post stairways are characterized by handrails that connect to the upper square block of the newel, creating a distinct, structured look.

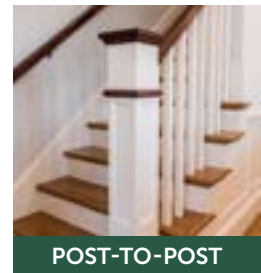

Pick Your Wood Species

Personalize your staircase with our exquisite selection of wood species, including Red Oak, White Oak, Poplar, Hard Maple, Mahogany, and Primed. For those seeking a unique flair, we also provide a broad array of custom wood species to align with your specific taste and style. From our standard offerings to your personalized selections, we are committed to creating a staircase that perfectly accentuates your home.



DISTRIBUTED THROUGH **DW DISTRIBUTION**

STOCKING



RED OAK



WHITE OAK



POPLAR

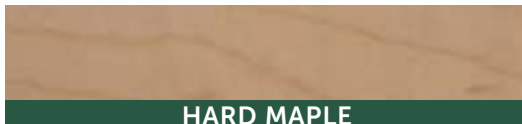

HARD MAPLE



MAHOGANY



PRIMED

WOOD SPECIES ABBREVIATIONS

RED OAK _____	RO
WHITE OAK _____	WO
POPLAR _____	POP
HARD MAPLE _____	HM
MAHOGANY _____	MAH
PRIMED _____	PRM
HICKORY _____	HIC
CHERRY _____	CHR
WALNUT _____	WAL
ALDER _____	ALD
BEECH _____	BEE
WHITE PINE _____	WPN
SOUTHERN YELLOW PINE _____	SYF
SPRUCE PINE FIR _____	SPF
BRAZILIAN CHERRY _____	BCH

SPECIAL ORDER



HICKORY



CHERRY



WALNUT



ALDER



BEECH



WHITE PINE



SOUTHERN YELLOW PINE



SPRUCE PINE FIR



BRAZILIAN CHERRY

Please call for other available special order species.

DISTRIBUTED THROUGH DW DISTRIBUTION

TRADITIONAL SERIES



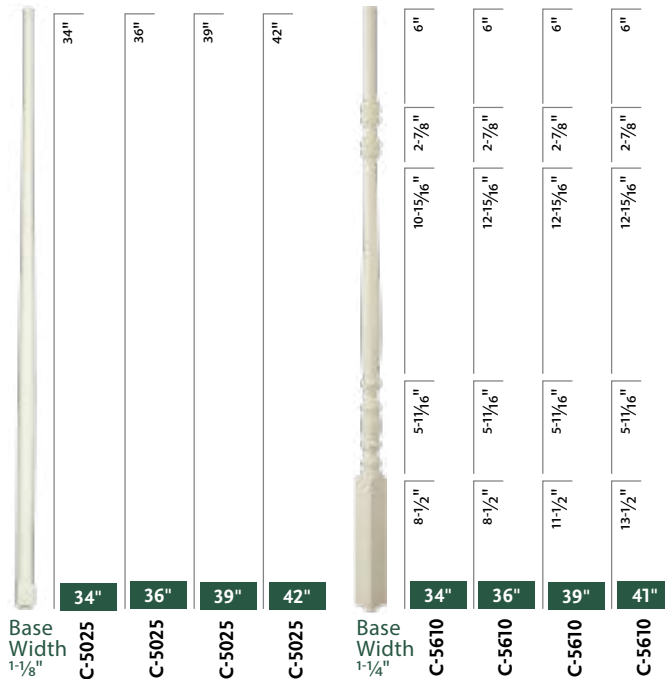
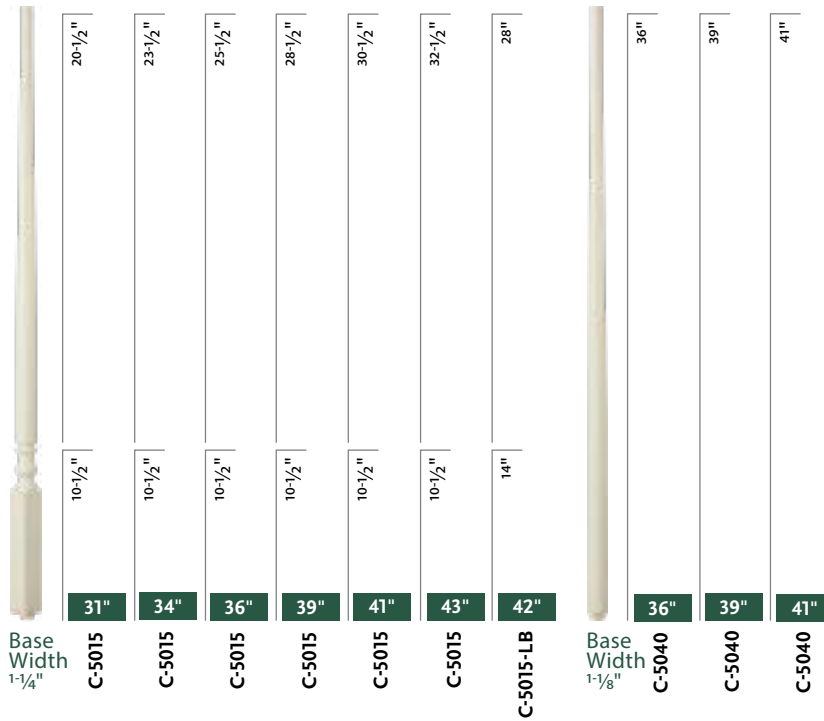



Pintop Balusters *Use with non-plowed handrail*



DISTRIBUTED THROUGH DW DISTRIBUTION

TRADITIONAL SERIES

Square Top Balusters

					
Base Width 1-1/4"	9-1/2"	9-1/2"	9-1/2"	9-1/2"	9-1/2"
	16-1/8"	19-1/8"	21-1/8"	24-1/8"	26-1/8"
	5-3/8"	5-3/8"	5-3/8"	5-3/8"	5-3/8"
	31"	34"	36"	39"	41"
	C-5070	C-5070	C-5070	C-5070	C-5070

					
Base Width 1-1/4"	6-7/8"	6-7/8"	6-7/8"	9-7/8"	11-7/8"
	19"	22"	24"	24"	24"
	5-1/8"	5-1/8"	5-1/8"	5-1/8"	5-1/8"
	31"	34"	36"	39"	41"
	C-5067	C-5067	C-5067	C-5067	C-5067



DISTRIBUTED THROUGH DW DISTRIBUTION

HAMPTON SERIES

Pintop Balusters

Use with non-plowed handrail

	6"	2-7/8"	10-15/16"	5-11/16"	8-1/2"	34"
C-5611	6"	2-7/8"	12-15/16"	5-11/16"	8-1/2"	36"
C-5611	6"	2-7/8"	12-15/16"	5-11/16"	11-1/2"	39"
C-5611	6"	2-7/8"	12-15/16"	5-11/16"	13-1/2"	41"

Base Width 1-3/4"

Square Top Balusters

Use with 1 3/4" plowed handrail

	5-3/4"	17-1/2"	12-3/4"	17-3/4"	8-1/2"	36"
C-5005	5-3/4"	17-1/2"	17-3/4"	17-3/4"	8-1/2"	41"

	6"	2-7/8"	10-15/16"	5-11/16"	8-1/2"	34"
C-5601	6"	2-7/8"	12-15/16"	5-11/16"	8-1/2"	36"
C-5601	6"	2-7/8"	12-15/16"	5-11/16"	11-1/2"	39"
C-5601	6"	2-7/8"	12-15/16"	5-11/16"	13-1/2"	41"

Base Width 1-3/4"



DISTRIBUTED THROUGH DW DISTRIBUTION

BRISTOL SERIES

Pintop Balusters

Use with non-plowed handrail

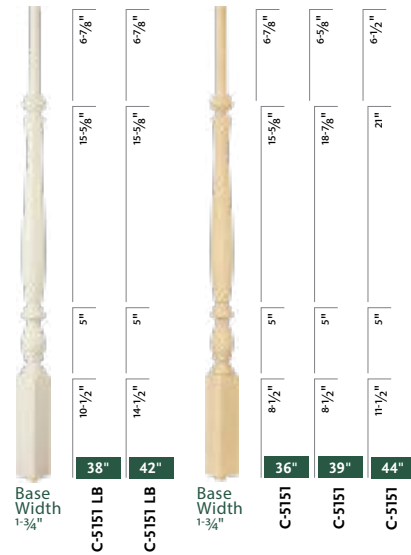

Square Top Balusters

Use with 1 3/4" plowed handrail



5151LB DETAIL



2315 DETAIL

ART DECO SERIES

Pintop Balusters

Use with non-plowed handrail



Round Base



5845 DETAIL



5151 DETAIL



5141 DETAIL

DISTRIBUTED THROUGH **DW DISTRIBUTION**

CHIPPENDALE SERIES

Pintop Balusters

Use with non-plowed handrail

	10-1/2"	9-1/2"	5-1/2"	8-1/2"	34"
C-5211	12-1/2"	9-1/2"	5-1/2"	8-1/2"	36"
C-5211	15-1/2"	9-1/2"	5-1/2"	8-1/2"	39"
C-5211	17-1/2"	9-1/2"	5-1/2"	8-1/2"	41"
Base Width 1-3/4"					

Square Top Balusters

Use with 1 3/4" plowed handrail

	6"	4-1/2"	9-1/2"	8-1/2"	34"
C-5201	6"	6-1/2"	9-1/2"	8-1/2"	36"
C-5201	6"	9-1/2"	9-1/2"	8-1/2"	39"
C-5201	6"	11-1/2"	9-1/2"	8-1/2"	41"
Base Width 1-3/4"					



MARION SERIES

Pintop Balusters

Use with non-plowed handrail

	25-1/2"	8-1/2"	8-1/2"	8-1/2"	34"
C-5251	27-1/2"	8-1/2"	8-1/2"	8-1/2"	36"
C-5251	30-1/2"	8-1/2"	8-1/2"	8-1/2"	39"
C-5251	32-1/2"	8-1/2"	8-1/2"	8-1/2"	41"
Base Width 1-3/4"					

Square Top Balusters

Use with 1 3/4" plowed handrail

	6"	19-1/2"	8-1/2"	8-1/2"	34"
C-5241	6"	21-1/2"	8-1/2"	8-1/2"	36"
C-5241	6"	24-1/2"	8-1/2"	8-1/2"	39"
C-5241	6"	26-1/2"	8-1/2"	8-1/2"	41"
Base Width 1-3/4"					



DISTRIBUTED THROUGH DW DISTRIBUTION

GATLIN SERIES

Pintop Balusters

Use with non-plowed handrail

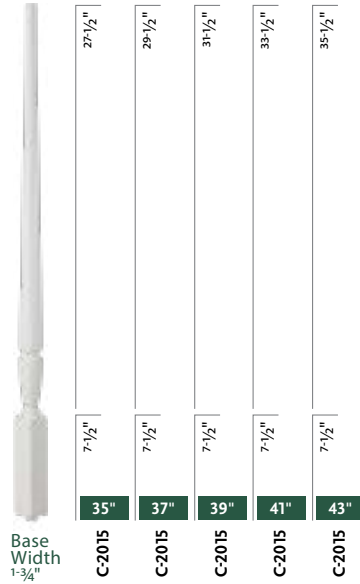

Square Top Balusters

Use with 1 3/4" plowed handrail



CRAFTSMAN SERIES

Square Top Balusters

Use with plowed handrail

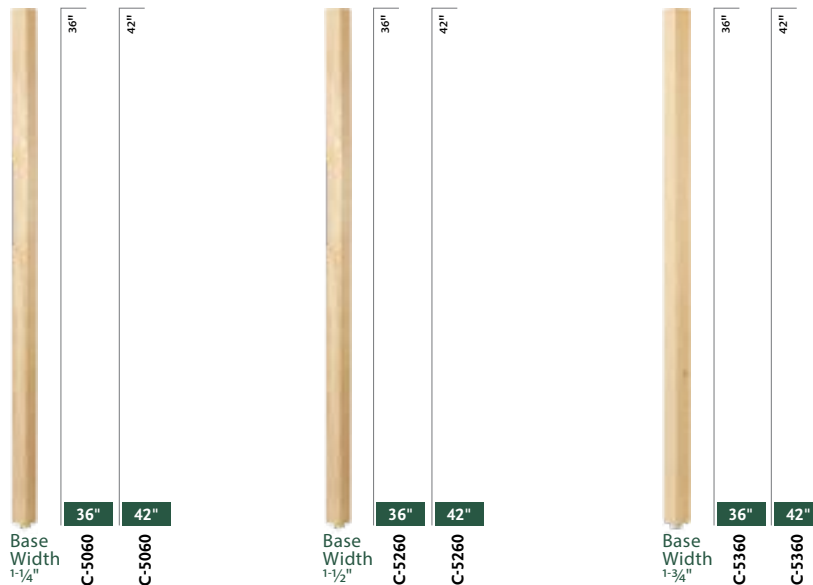

DISTRIBUTED THROUGH **DW DISTRIBUTION**

1/2" Iron Baluster Options

TWIST & BASKET SERIES

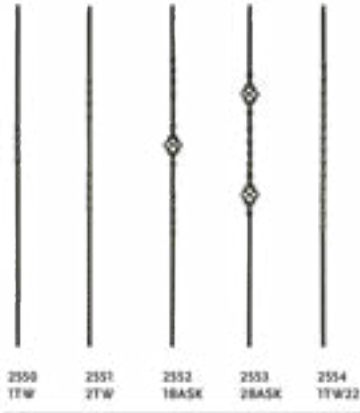

VERSATILE SERIES



RIBBON SERIES



KNEE WALL SERIES

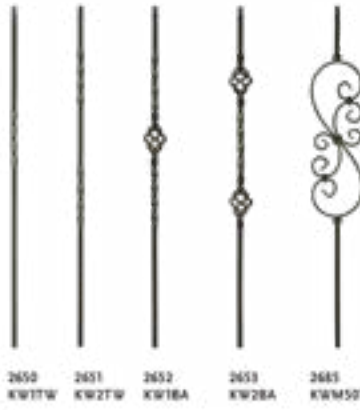

SCROLL SERIES

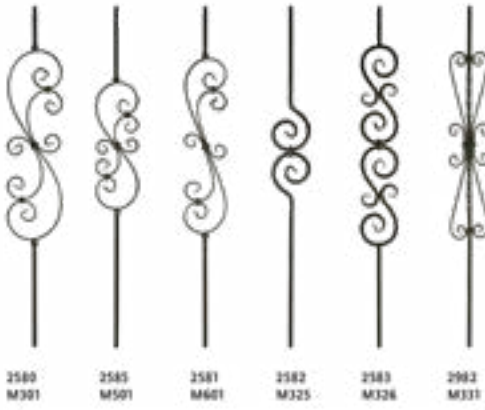

MEDALLION SERIES

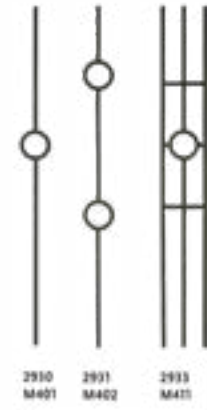

BELLY SERIES



ROUND SERIES



LIBERTY SERIES

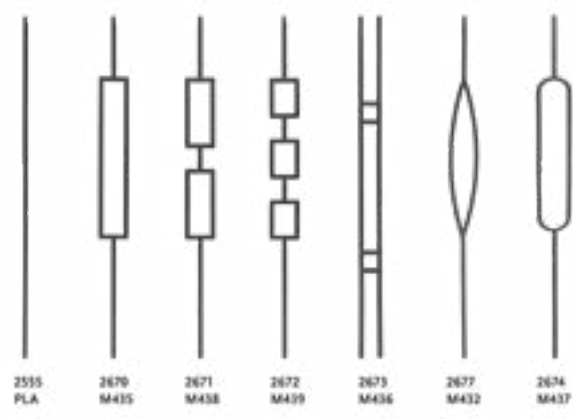

DISTRIBUTED THROUGH DW DISTRIBUTION

9/16" Iron Baluster Options

MEDITERRANEAN

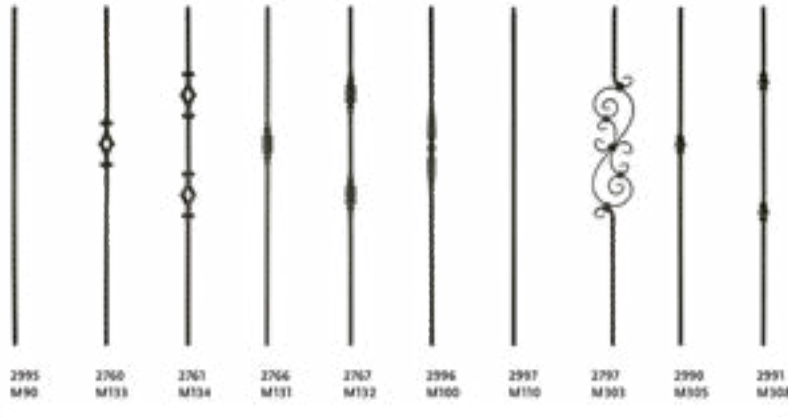

GOTHIC



5/8" Iron Baluster Options

5/16" ROUND SERIES



VENETIAN SERIES



MODERN VENETIAN SERIES



3/4" Iron Baluster Options

MEGA BALUSTER SERIES

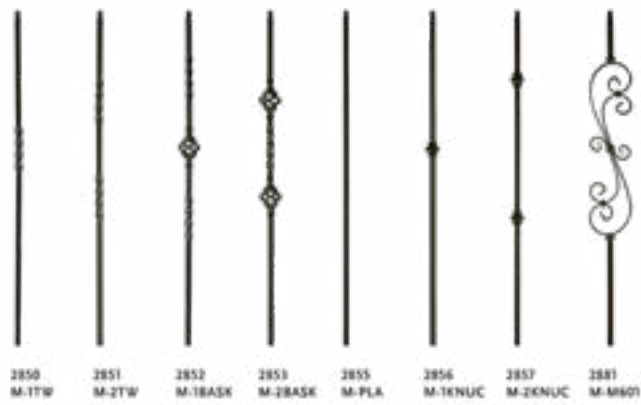

DISTRIBUTED THROUGH DW DISTRIBUTION

COFFMAN® STAIR PARTS

IRON NEWELS, IRON SHOE & KNUCKLE OPTIONS



Iron Newels



DECORATIVE PANELS

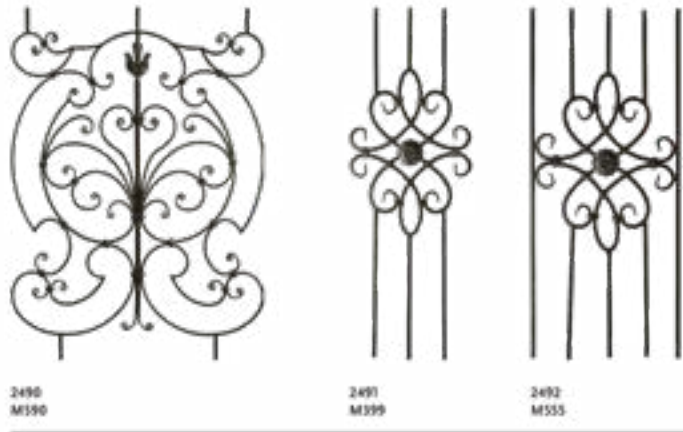

Shoe & Knuckle Options

1/2" SHOES



1/2" ROUND SHOES



1/4" SHOES



1/4" SHOES



1/4" ROUND SHOES



1/4" SHOES

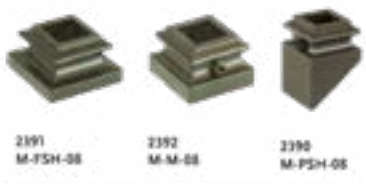

UNIVERSAL (1/2" OR 1/4") SHOES



NEWEL KIT



DISTRIBUTED THROUGH DW DISTRIBUTION

Box Newels



Post-to-Post Systems



Over-the-Post Systems



DISTRIBUTED THROUGH **DW DISTRIBUTION**

TRADITIONAL SERIES

Lengths Available: 8', 10', 12', 14', 16', 18', and 20'



C-6010
Non-Plowed
2-1/4" x 2-3/8"
Avail: FJ· SC· ENG· SS

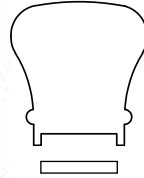

C-6010P
Plowed 1-1/4"
2-1/4" x 2-3/8"
(Not available in 20')

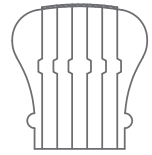

C-6016
Bending Rail
2-1/4" x 2-3/8"

CLASSIC SERIES

Lengths Available: 8', 10', 12', 14', 16', 18', and 20'

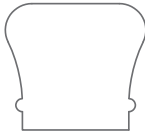

C-6210
Non-Plowed
2-5/8" x 2-3/8"
Avail: FJ· SC· ENG

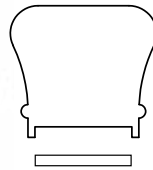

C-6210P1
Plowed 1-3/4"
2-5/8" x 2-3/8"

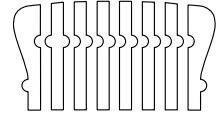

C-6216
Bending Rail
2-5/8" x 2-3/8"
Avail: 12', 16', 18', 20'

BRISTOL SERIES

Lengths Available: 8', 12', and 16'



C-6110
Non-Plowed
2-3/4" x 2-3/4"
Avail: SC

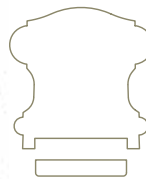

C-6110P1
Plowed 1-3/4"
2-3/4" x 2-3/4"

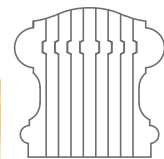

C-6116
Bending Rail
2-3/4" x 2-3/4"
(Comes in 20')

DISTRIBUTED THROUGH **DW DISTRIBUTION**

RICHMOND SERIES

Lengths Available: 8', 12', and 16'

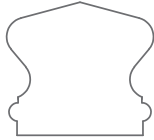

C-6410
Non-Plowed
2-5/8" x 2-3/8"
Avail: SC, ENG



C-6410P1
Plowed 1-3/4"
2-5/8" x 2-3/8"

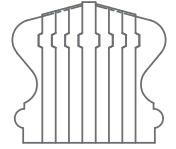

C-6416
Bending Rail
2-5/8" x 2-3/8"

GEORGIAN SERIES

Lengths Available: 8', 12', and 16'



C-6310
Non-Plowed
2-5/8" x 2-1/4"
Avail: SC

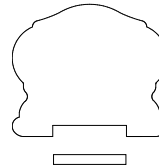

C-6310P1
Plowed 1-3/4"
2-5/8" x 2-1/4"

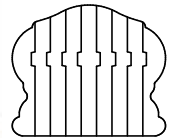

C-6316
Bending Rail
2-5/8" x 2-1/4"

FILLET

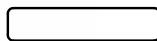
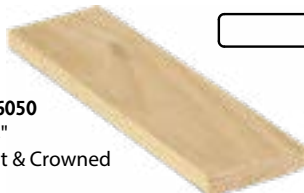

C-6050
1-1/4"
Flat & Crowned

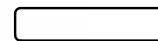

C-6007
1-3/4"
Flat

DISTRIBUTED THROUGH **DW DISTRIBUTION**

COFFMAN® STAIR PARTS

RAIL SERIES



CHATHAM SERIES

Lengths Available: 16'

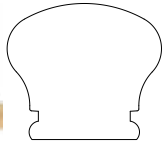

C-6009
Non-Plowed
2-5/8" x 2-5/16"
Avail: SC

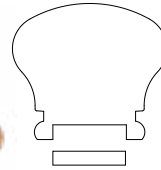

C-6009P
Plowed 1-1/4"
2-5/8" x 2-5/16"

CRAFTSMAN SERIES

Lengths Available: 8', 12', and 16'
(Varies from 8' - 20' by profile)



C-6700
Non-Plowed
2-1/2" x 1-5/8"
Avail: FJ·SC



C-6700P
Plowed 1-1/4"
2-1/2" x 1-5/8"

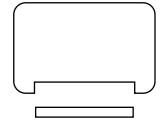

C-6700P1
Plowed 1-3/4"
2-1/2" x 1-5/8"



C-6100
Non-Plowed
2-1/4" x 1-5/8"
Avail: SC

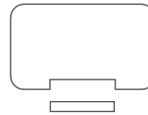

C-6100P
Plowed 1-1/4"
2-1/4" x 1-5/8"

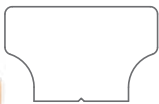

C-6840
Non-Plowed
2-5/8" x 1-5/8"
Avail: FJ·SC

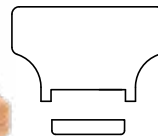

C-6840P
Plowed 1-1/4"
2-5/8" x 1-5/8"

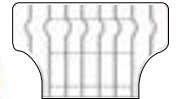

C-6816
Bending Rail
2-5/8" x 1-5/8"

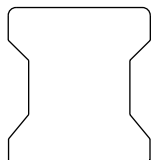

C-6600
Non-Plowed
2-7/16" x 2-1/4"

DISTRIBUTED THROUGH DW DISTRIBUTION

SHOE RAIL

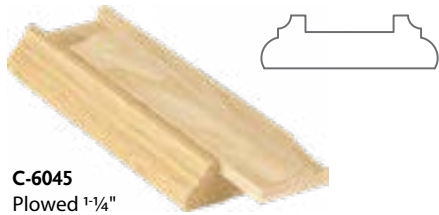

C-6045
Plowed 1-1/4"
2-1/2" x 3/4"
Avail: FJ



C-6006
Plowed 1-3/4"
2-5/8" x 2-1/4"
Avail: FJ

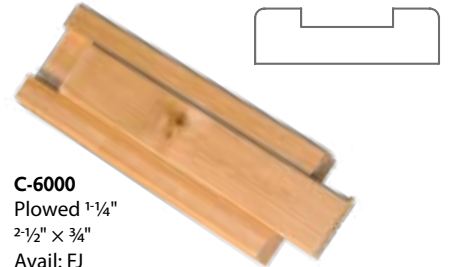

C-6000
Plowed 1-1/4"
2-1/2" x 3/4"
Avail: FJ

WALL RAIL



C-6040
1-11/16" x 1-1/2"
Avail: FJ



C-7023
Quarterturn
Use with C-6040



C-7024
Starting Easing
Use with C-6040



C-6042
2-1/4" x 1-9/32"
Avail: FJ



C-7025
Starting Easing
Use with C-6040



C-7005
Quarterturn
Use with C-6042

DISTRIBUTED THROUGH **DW DISTRIBUTION**

COFFMAN® STAIR PARTS

RAIL FITTINGS



TRADITIONAL	BRISTOL	CLASSIC	GEORGIAN	RICHMOND	CRAFTSMAN	CHATHAM
C-6010	C-6110	C-6210	C-6310	C-6410	C-6840	C-6009

STARTING FITTINGS SHOULD BE USED WITH PINTOP NEWELS AT THE BASE OF THE STAIRCASE.



	TRADITIONAL	BRISTOL	CLASSIC	GEORGIAN	RICHMOND	CRAFTSMAN	CHATHAM
VERTICAL VOLUTE	C-7031						
LEFT HAND VOLUTE USE WITH PIN TOP NEWELS	C-7030	C-7130	C-7230	C-7330	C-7430		
RIGHT HAND VOLUTE USE WITH PIN TOP NEWELS	C-7035	C-7135	C-7235	C-7335	C-7435		
STARTING EASING WITH CAP	C-7010	C-7110	C-7210	C-7310	C-7410	C-7810	
LEFT HAND TURNOUT	C-7040	C-7140	C-7240	C-7340	C-7440		
RIGHT HAND TURNOUT	C-7045	C-7145	C-7245	C-7345	C-7445		

STARTING FITTINGS

DISTRIBUTED THROUGH **DW DISTRIBUTION**



TRADITIONAL C-6010	BRISTOL C-6110	CLASSIC C-6210	GEORGIAN C-6310	RICHMOND C-6410	CRAFTSMAN C-6840	CHATHAM C-6009
-----------------------	-------------------	-------------------	--------------------	--------------------	---------------------	-------------------

TRANSITION FITTINGS ARE USED TO CREATE A CONTINUAL RAILING WITH ALL APPLICATIONS.



	TRADITIONAL C-6010	BRISTOL C-6110	CLASSIC C-6210	GEORGIAN C-6310	RICHMOND C-6410	CRAFTSMAN C-6840	CHATHAM C-6009
COPEd END	C-7007		C-7207				
RETURNED END	C-7009	C-7109	C-7209				
LEVEL QUARTERTURN 90°	C-7011	C-7111	C-7211	C-7311	C-7411	C-7811	C-7C11
UP EASING	C-7012S	C-7112S	C-7212S	C-7312S	C-7412S	C-7812S	C-7C12S
OVEREASING	C-7013	C-7113	C-7213	C-7313	C-7413	C-7813	C-7C13
UP EASING 90°	C-7014S	C-7114S	C-7214S	C-7314S	C-7414S		C-7C14
OVER EASING RETURNED END	C-7016		C-7216				
OPENING CAP USE WITH PIN TOP NEWELS	C-7019	C-7119	C-7219	C-7319	C-7419		
TANDEM CAP USE WITH PIN NEWELS	C-7020	C-7120	C-7220	C-7320	C-7420		
QUARTERTURN CAP 90° USE WITH PIN NEWELS	C-7021	C-7121	C-7221	C-7321	C-7421		
LEVEL TURN 135° USE WITH PIN TOP NEWELS	C-7022	C-7122	C-7222		C-7422		
LEVEL TURN 135°	C-7026	C-7126	C-7226				
5" CENTER TO CENTER LEFT LH S TURN	C-7047LH	C-7147LH	C-7247LH		C-7447LH		
5" CENTER TO CENTER RIGHT RH S TURN	C-7047RH	C-7147RH	C-7247RH		C-7447RH		

TRANSITIONAL FITTINGS

DISTRIBUTED THROUGH DW DISTRIBUTION

COFFMAN® STAIR PARTS

RAIL FITTINGS



TRADITIONAL C-6010	BRISTOL C-6110	CLASSIC C-6210	GEORGIAN C-6310	RICHMOND C-6410	CRAFTSMAN C-6840	CHATHAM C-6009
-----------------------	-------------------	-------------------	--------------------	--------------------	---------------------	-------------------

GOOSENECK FITTINGS ARE USED TO JOIN A HANDRAIL THAT RUNS PARALLEL WITH THE STRINGER TO A HIGHER HANDRAIL ON A LANDING OR BALCONY



	TRADITIONAL C-6010	BRISTOL C-6110	CLASSIC C-6210	GEORGIAN C-6310	RICHMOND C-6410	CRAFTSMAN C-6840	CHATHAM C-6009
LEFT HAND 2 RISER NO CAP 90°	C-7071			C-7371			
RIGHT HAND 2 RISER NO CAP 90°	C-7076			C-7376			
2 RISER WITH TANDEM CAP USE WITH PIN NEWELS	C-7089		C-7289	C-7389	C-7389		
2 RISER NO CAP	C-7099	C-7199	C-7299	C-7399	C-7499	C-7899	C-7C99
LEFT HAND 90° 2 RISER WITH CAP USE WITH PIN TOP NEWELS	C-7060		C-7260				
RIGHT HAND 90° 2 RISER WITH CAP USE WITH PIN TOP NEWELS	C-7065		C-7265				

GOOSENECK FITTINGS

DISTRIBUTED THROUGH DW DISTRIBUTION



TRADITIONAL C-6010	BRISTOL C-6110	CLASSIC C-6210	GEORGIAN C-6310	RICHMOND C-6410
-----------------------	-------------------	-------------------	--------------------	--------------------

GOOSENECK FITTINGS ARE USED TO JOIN A HANDRAIL THAT RUNS PARALLEL WITH THE STRINGER TO A HIGHER HANDRAIL ON A LANDING OR BALCONY



LEFT HAND 2 RISER WITH CAP 135° USE WITH PIN TOP NEWELS	C-7061		C-7261		GOOSENECK FITTINGS CONT.
RIGHT HAND 2 RISER WITH CAP 135° USE WITH PIN TOP NEWELS	C-7066		C-7266		
LEFT HAND 2 RISER WITH CAP USE WITH PIN TOP NEWELS	C-7081		C-7281		
RIGHT HAND 2 RISER WITH CAP USE WITH PIN TOP NEWELS	C-7086		C-7286		
2 RISER WITH CAP USE WITH PIN TOP NEWELS	C-7097		C-7297		

DISTRIBUTED THROUGH **DW DISTRIBUTION**

COFFMAN® STAIR PARTS

ROSETTES, STARTING STEPS



ROSETTES

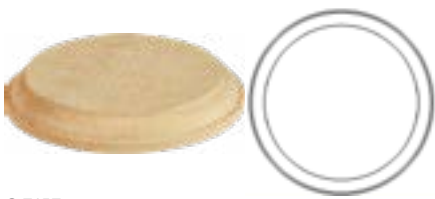

C-7217
 $5\frac{3}{8}'' \times 5\frac{3}{8}'' \times \frac{3}{4}''$
 Top panel width $4\frac{1}{2}''$

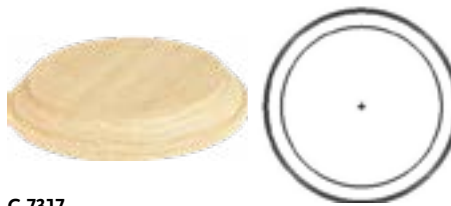

C-7317
 $4\frac{5}{8}'' \times 4\frac{5}{8}'' \times \frac{3}{4}''$
 Top panel width $3\frac{3}{4}''$



C-7337
 $4'' \times 5\frac{1}{2}'' \times \frac{3}{4}''$
 Top panel width $3\frac{1}{8}''$



C-7237
 $4\frac{5}{16}'' \times 6\frac{3}{16}'' \times \frac{3}{4}''$
 Top panel width $3\frac{1}{2}''$



C-7318
 $4\frac{3}{16}'' \times 5\frac{3}{8}'' \times \frac{3}{4}''$
 Top panel width $3\frac{5}{16}''$



C-7227
 $4\frac{3}{16}'' \times 4\frac{3}{16}'' \times \frac{3}{4}''$

STARTING STEPS

All Coffman Starting Steps are shipped with the necessary cove and shoe moulding.
 Single Bullnose Steps are Reversible and can be trimmed to length.



C-8010
 Usable with all Standard Turnouts and Volutes
 Avail: 48", 54", 60", and 72"



C-8015
 Usable with all Standard Turnouts and Volutes
 Avail: 48", 54", and 60"

C-8016
 Usable with all Standard Turnouts and Volutes as well as adjustable sizes for exact finishing fit
 Avail:
 48" (trim from 43" to 48")
 53" (trim from 48" to 53")
 58" (trim from 53" to 58")



C-8030
 Usable for Post-to-Post systems and works well with Box Newels
 Avail: 48" and 60"

DISTRIBUTED THROUGH **DW DISTRIBUTION**

SWAGELESS FITTINGS



803973
Tensioning Level Fitting



803972
Non-Tensioning Level Fitting



803975
Tensioning Rake Fittings



803974
Non-Tensioning Rake Fittings

HOLLOW TUBES



Tube-065
5/8" X 96" — SAT, SS, BLK, AG
5/8" X 60" — SAT



Tube-050
1/2" X 96" — SAT, SS, AG
1/2" X 240" — SS

CABLE KIT SERIES - 102



SL-10205	5' KIT	SILVER LININGS CABLE RAIL KIT - 5'	803964
SL-10210	10' KIT	SILVER LININGS CABLE RAIL KIT - 10'	803965
SL-10215	15' KIT	SILVER LININGS CABLE RAIL KIT - 15'	803966
SL-10220	20' KIT	SILVER LININGS CABLE RAIL KIT - 20'	803967
SL-10225	25' KIT	SILVER LININGS CABLE RAIL KIT - 25'	803968
SL-10230	30' KIT	SILVER LININGS CABLE RAIL KIT - 30'	803969
SL-10240	40' KIT	SILVER LININGS CABLE RAIL KIT - 40'	803970
SL-10250	50' KIT	SILVER LININGS CABLE RAIL KIT - 50'	803971



C-6700
Non-Plowed
2-1/2" X 1-5/8"



C-6840
Non-Plowed
2-5/8" X 1-5/8"

DISTRIBUTED THROUGH **DW DISTRIBUTION**

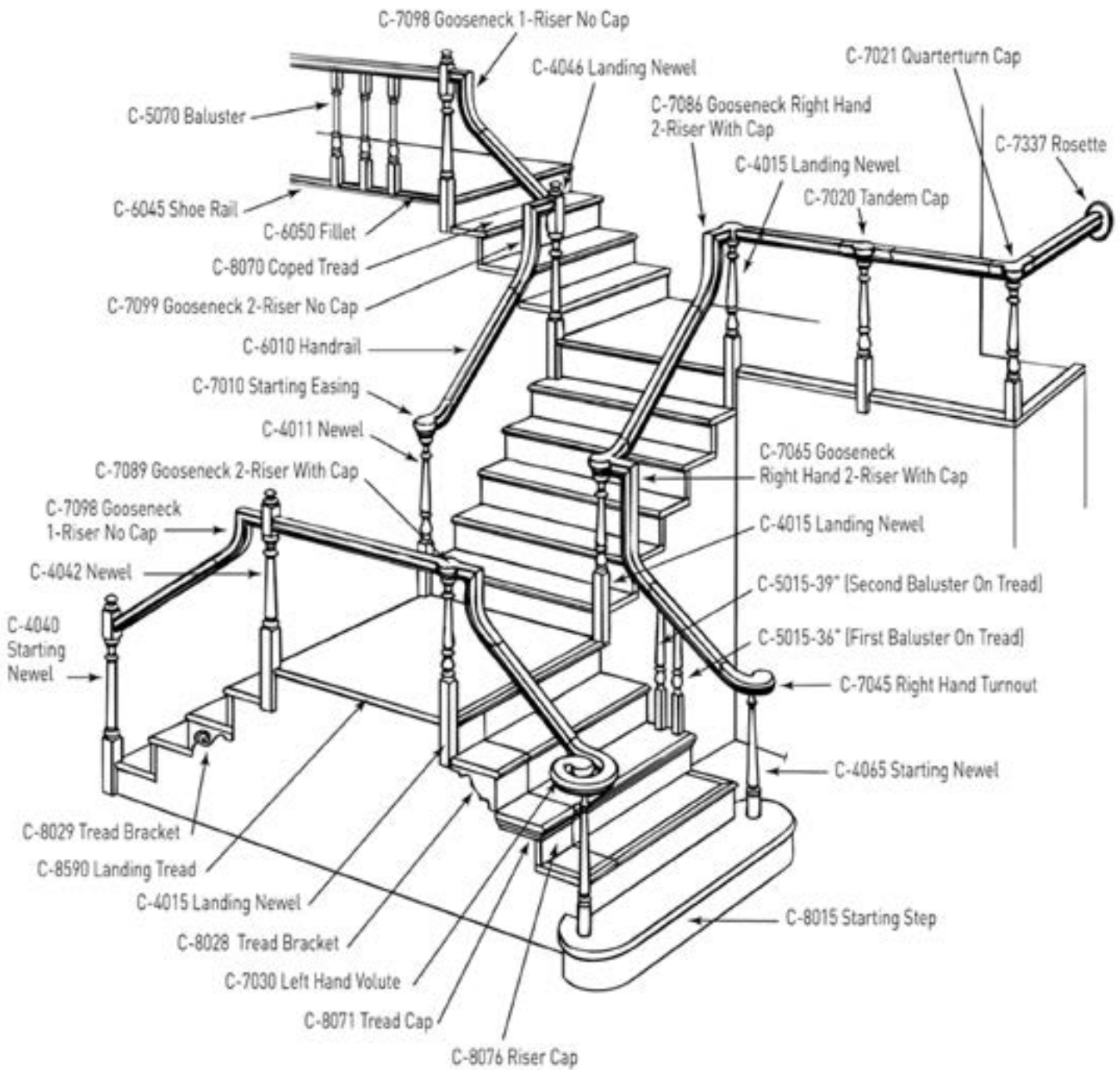

WWW.WM-COFFMAN.COM FOR STAIR BUILDING GUIDE



DOOR & MILLWORK

ATTIC STAIRS

444 SERIES

350 lb Duty Rating



OVERVIEW

- ★ 1x4 solid wood frame and stringer
- ★ 1x4 tread with safety grooves
- ★ Fits ceiling heights from 7'6" to 10'4"

FEATURES

- ★ Meets or exceeds **ANSI 14-9 Standards for attic stairs**
- ★ Adjustable spring tension
- ★ High grade, kiln-dried, yellow pine lumber
- ★ Full-width continuous hinge
- ★ Galvanized steel hardware with safety edge
- ★ 3/16" **steel rod under treads**
- ★ Safety grooved treads
- ★ Securely bolted wooden handrail
- ★ Clear plywood panel

OPTIONS

- ★ Fire Retardant Treated panels compliant with ASTM E84
- ★ Energy Saving Packages
- ★ Pull down rod with eye hook

STANDARD OPENING SIZES

- ★ 22-1/2" wide x 54" long
- ★ 25-1/2" wide x 54" long



Residential use only



655+ SERIES

375 lb Duty Rating



OVERVIEW

- ★ 1x5 solid wood frame and stringer
- ★ 1x6 solid wood treads with safety grooves
- ★ Fits ceiling heights from 7'6" to 10'4"

FEATURES

- ★ Fully assembled and **ready to install**
- ★ Meets or exceeds ANSI 14-9 Standards for attic stairs
- ★ Heavy duty galvanized steel hardware with "Safety Edge"
- ★ Adjustable spring tension
- ★ Full-width continuous hinge
- ★ Complete easy-to-follow installation instructions
- ★ High grade, kiln-dried, yellow pine lumber
- ★ CARB certified clear plywood panel
- ★ **Lifetime Spring Warranty**
- ★ Durable Wooden Handrail

OPTIONS

- ★ Fire Retardant Treated panel compliant with ASTM E84
- ★ Energy Saving Packages
- ★ 10'9" Model Available
- ★ Pull down rod with eye hook

STANDARD OPENING SIZES

- ★ 22-1/2" wide x 54" long
- ★ 25-1/2" wide x 54" long
- ★ 30" wide x 54" long



Residential use only



LOUISVILLE LADDER

ELITE ALUMINUM ATTIC LADDER



ELITE



MODEL AL2240MG

ALUMINUM ATTIC LADDER

TYPE IAA

375 LBS
LOAD CAPACITY

(Includes weight of user plus materials)

**NEW
PRODUCT**



T-HANDLE
FOR EASY
ACCESS

WITH
INSULATION
PACKAGE AND
WIDER
CLEARANCE

**22" WIDE
OPENING**

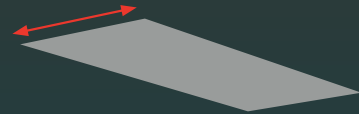

WEATHER STRIPPING
THAT **REDUCES
ENERGY LOSS**



**BUILT TO
BE
ABOVE**



ELITE

MODEL AL2240MG

1 Lighter Aluminum Frame
 Pre-drilled holes for easier installation.



2 Smooth Operation
 Easier to open and close. Door with gas piston system.



3 Energy Efficiency
 Weather stripping that reduces energy loss.



4 Adjustable Shoes
 Fits heights 7-ft 8 in to 10-ft 3-in.



5 Safety
 Aluminum handrail for a comfortable transition.

AL2240MG FLYER 2023 © Louisville Ladder, Inc. All rights reserved.

MODEL	FITS CEILING HEIGHTS		ROUGH OPENING	APPROX. LANDING SPACE	SWING CLEARANCE	STEP DEPTH	APPROX. WEIGHT (LBS)	APPROX. CUBES (FT)
	MIN	MAX						
AL2240MG	7' 8"	10' 3"	22.5" X 54"	67"	74"	3"	40.8	6.6

LOUISVILLE LADDER

ENERGY EFFICIENT ALUMINUM ATTIC LADDER



**ENERGY
EFFICIENT**



MODEL
AL2540MG-R10

ALUMINUM ATTIC LADDER

TYPE IAA

375 LBS
LOAD CAPACITY

(Includes weight of user plus materials)

WITH
INSULATION
PACKAGE AND
WIDER
CLEARANCE

25" WIDE
OPENING



**R10
INSULATED
DOOR**



WEATHER STRIPPING
THAT **REDUCES
ENERGY LOSS**

**NEW
PRODUCT**



T-HANDLE
FOR EASY
ACCESS

LOUISVILLE
LADDER
**BUILT TO BE
ABOVE**

ANSI
Meets or exceeds requirements
of American National Standards
ANSI A14.9



ENERGY EFFICIENT

 MODEL
AL2540MG-R10

1 Lighter Aluminum Frame
 Pre-drilled holes for easier installation.



2 Smooth Operation
 Easier to open and close. Door with gas piston system.



3 Superior Energy Efficiency
 R10 insulated door with weather stripping that reduces energy loss.



4 Adjustable Shoes
 Fits heights 7-ft 8 in to 10-ft 3-in.



5 Safety
 Aluminum handrail for a comfortable transition.



AL2540MG-R10 FLYER 2023 © Louisville Ladder, Inc. All rights reserved.

MODEL	FITS CEILING HEIGHTS		ROUGH OPENING	APPROX. LANDING SPACE	SWING CLEARANCE	STEP DEPTH	APPROX. WEIGHT (LBS)	APPROX. CUBES (FT)
	MIN	MAX						
AL2540MG-R10	7' 8"	10' 3"	25.5" X 54"	67"	74"	3"	62.4	8.9

THE TITAN

Strong and Durable 375 lb Load Capacity



These heavy duty aluminum attic stairs are made with high quality aluminum and offer a limited lifetime warranty on the springs and aluminum sections. The TITAN gives extra utility to what is already the best value component in a home: valuable attic storage.

OVERVIEW

- ✓ 375 lb duty rating
- ✓ Heavy duty aluminum sections
- ✓ Standard Energy-Saver R-3 Door Panel
- ✓ Adjustable Foot Support with rubberized foot pads
- ✓ Meets or exceeds **ANSI 14-9 Standards for Attic Stairs**

FEATURES

- ✓ Fully assembled and **ready to install**
- ✓ Adjustable spring tension
- ✓ Full-width continuous hinge
- ✓ Heavy duty galvanized steel hardware
- ✓ Pull-down rod with eye hook
- ✓ Secure easy grip handrail
- ✓ CARB certified plywood
- ✓ **Lifetime Spring Warranty**

OPTIONS

- ✓ Optional 12' Ceiling height
- ✓ Optional Fire Retardant treated panels compliant with ASTM E84

Dimensions & Available Sizes



Residential use only

 **FAKRO[®]**

ATTIC STAIRS

LMF-R BASIC FIRE RETARDANT METAL FOLDING LADDER

BASIC FIRE RETARDANT METAL FOLDING ATTIC LADDER

LMF-R

**FIRE-RETARDANT
INSULATED**

5.6
R-value

max
375
lbs

The **LMF-R** is a fire-retardant metal attic ladder with an insulated door and folding sections. It's ideal for residential or light commercial use where added fire protection is needed. A built-in gasket reduces air leakage, and the handrail improves safety.

- insulated, fire-retardant plywood door, ready to paint
- weather seal gasket
- handrail
- adjustable ends with rubber caps
- non-slip steps
- ladder length adjustment after cutting
- additional accessories available – page 11
- 1 year warranty



ATTIC LADDER DIMENSIONS

LMF-R		22½"x54"	25"x54"
Manufacturer's part number		869539	869540
Ceiling height	H	8' – 10'3"	
Rough opening	WxL	22½"x54"	25"x54"
Outside frame dimensions		22"x53½"	24½"x53½"
Inside frame dimensions		20½"x51¾"	23" x 51¾"
Projection	R	66 ½"	
Landing space	C	51"	
Folded ladder height	K	10"	
Board movement after opening	P	1 ½"	
Frame height		5 ½"	
Approx. Weight (lbs)		77	79,5
Step width	E	13 ⅜"	
Step depth		3 ⅝"	
Step thickness		1 ¼"	
Distance between steps		9 ⅞"	

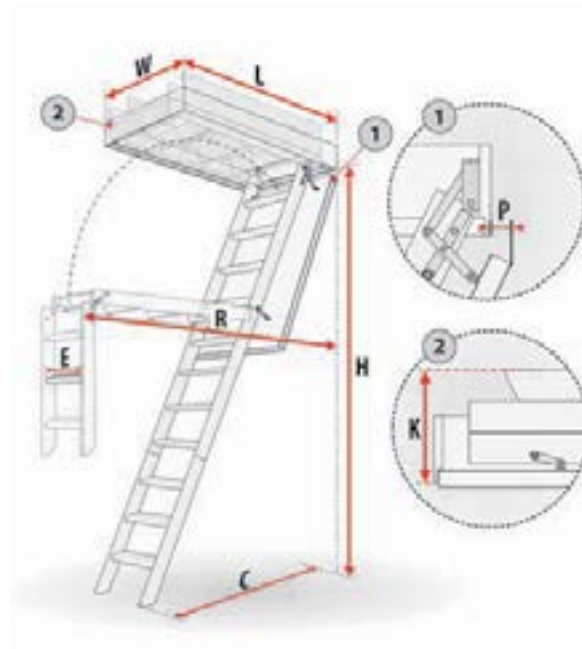

Available only in sizes given above.

BASIC FIRE RETARDANT METAL FOLDING ATTIC LADDER 12'



Installation brackets included.



insulated, fire-retardant plywood door, ready to paint



weather seal gasket



ladder length adjustment after cutting



plastic ends



non-slip steps



1 year warranty



The last step of the ladder placed high in the box.



2 x steel crossbar for increased strength of the entire structure.



The unloading mechanism is integrated into the handrail, assisting with folding and unfolding the ladder.



Special lock prevents accidental folding.

LMP-R 12'

FIRE-RETARDANT INSULATED

5.6 R-value

max 375 lbs

The LMP-R is a fire-retardant metal attic ladder designed for high ceilings, reaching up to 12 feet. It features an insulated door, durable metal construction, and is ideal for residential use.



increased distance between step and lid improves safety and comfort

ATTIC LADDER DIMENSIONS

		22½"x56½"	25"x56½"	30"x56½"
LMP-R 12'		22½"x56½"	25"x56½"	30"x56½"
Manufacturer's part number		869519	869520	869521
Ceiling height	H	9'5" – 12'		
Rough opening	WxL	22½"x 56½"	25"x 56½"	30"x 56½"
Outside frame dimensions		22" x 56"	24½" x 56"	29½" x 56"
Inside frame dimensions		20½" x 54¾"	22¾" x 54¾"	28" x 54¾"
Projection	R	78"		
Landing space	C	58"		
Folded ladder height	K	12 5/8"		
Board movement after opening	P	3/8"		
Frame height		7 3/32"		
Approx. Weight (lbs)		104	107	114
Step width	E	13 3/8"		
Step depth		3 1/8"		
Step thickness		1 1/4"		
Distance between steps		9 1/2"		

Available only in sizes given above.

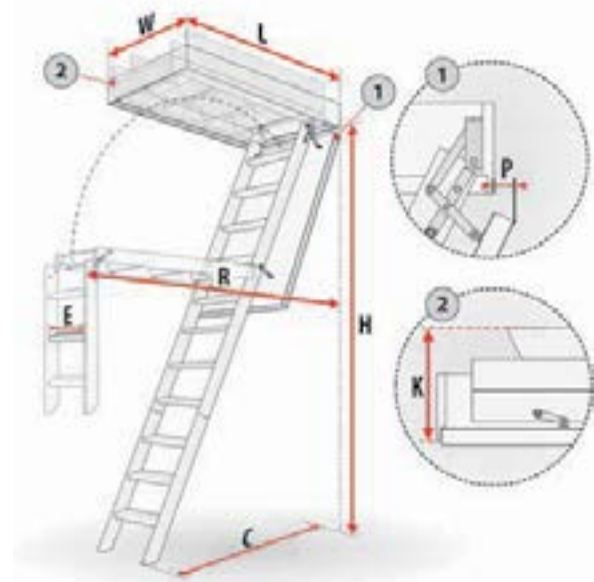

BASIC WOODEN FOLDING ATTIC LADDER

LWB
INSULATED

5.0
R-value

max
350
lbs



- insulated door ready to paint
- weather seal gasket
- non-slip steps
- handrail
- additional accessories available – page 10-11
- 1 year warranty



The **LWB** model is an insulated attic ladder built from pine wood. It provides easy access to attics without the hassle of using a big step ladder. Each ladder is equipped with a handrail, a door that keeps out the cold, and a special seal that prevents heat loss.



increased distance between step and lid improves safety and comfort

ATTIC LADDER DIMENSIONS

		22½"x54"	25"x54"	30"x54"
LWB		22½"x54"	25"x54"	30"x54"
Manufacturer's part number		869193	869194	869195
Ceiling height	H	8' – 10'4"		
Rough opening	WxL	22½"x54"	25"x54"	30"x54"
Outside frame dimensions		22"x53½"	24½"x53½"	29½"x53½"
Inside frame dimensions		20½"x51¾"	23" x 51¾"	28"x51¾"
Projection	R	67 ⅞"		
Landing space	C	50 ⅞"		
Folded ladder height	K	10 ⅞"		
Board movement after opening	P	1 ½"		
Frame height		5 ½"		
Approx. Weight (lbs)		62,5	64	67
Step width	E	13 ⅜"		
Step depth		3 ⅞"		
Step thickness		7/8"		
Distance between steps		9 7/8"		

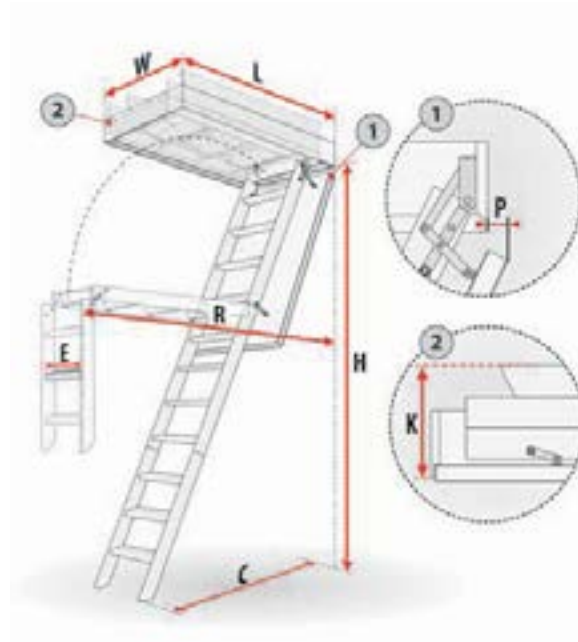

Available only in sizes given above.

BASIC METAL FOLDING ATTIC LADDER

- FEATURES
-  insulated door ready to paint
 -  weather seal gasket
 -  plastic ends
 -  non-slip steps
 -  handrail
 -  additional accessories available – page T1
 -  1 year warranty



3.7
R-value



max
375
lbs

LMB
BASIC
-INSULATED

The **LMB** model is a basic insulated metal attic ladder. This reliable ladder provides easy access to your attic space with its convenient handrail, insulated door, and weather seal gasket. Designed for functionality and energy efficiency, it ensures both safety and comfort.



increased distance between step and lid improves safety and comfort

				
LMB		22½"x54"	25"x54"	30"x54"
Manufacturer's part number		869263	869264	869265
Ceiling height	H	7' 9 7/8" – 10'3"		
Rough opening	WxL	22½"x54"	25"x54"	30"x54"
Outside frame dimensions		22"x53½"	24½"x53½"	29½"x53½"
Inside frame dimensions		20½"x51¾"	23"x51¾"	28"x51¾"
Projection	R	65 5/8"		
Landing space	C	50 ½"		
Folded ladder height	K	9½"		
Frame height		5½"		
Approx. Weight (lbs)		69	71	76
Step width	E	13 3/8"		
Step depth		3 1/8"		
Step thickness		1 1/4"		
Distance between steps		9 7/8"		



Available only in sizes given above.

LST METAL SCISSOR ATTIC LADDER

METAL SCISSOR ATTIC LADDER

LST
INSULATED

5.2
R-value

max
350
lbs

The **LST** model is a scissor style attic ladder with a white, insulated hatch. Its construction takes up less space and requires less room to unfold. Making it perfect for small spaces (the smallest ladder size is 22"x31").



Wooden box with metal trim and quick-installation brackets included.

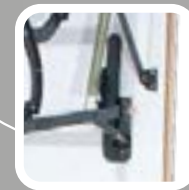









Adjustment of ladder length.



Adjustable length by adding or detaching a step.

FEATURES

-  insulated door with white finish
-  weather seal gasket
-  white metal trim
-  non-slip steps
-  can add or detach steps

-  system of adjusting the ladder length to the ceiling height
-  quick installation in the ceiling – installation brackets
-  additional accessories available – pages 35-38
-  2 year warranty

R-value
with optional upper hatch



Details p.37

fully assembled and ready for quick installation in the ceiling



LST – DIAGRAM

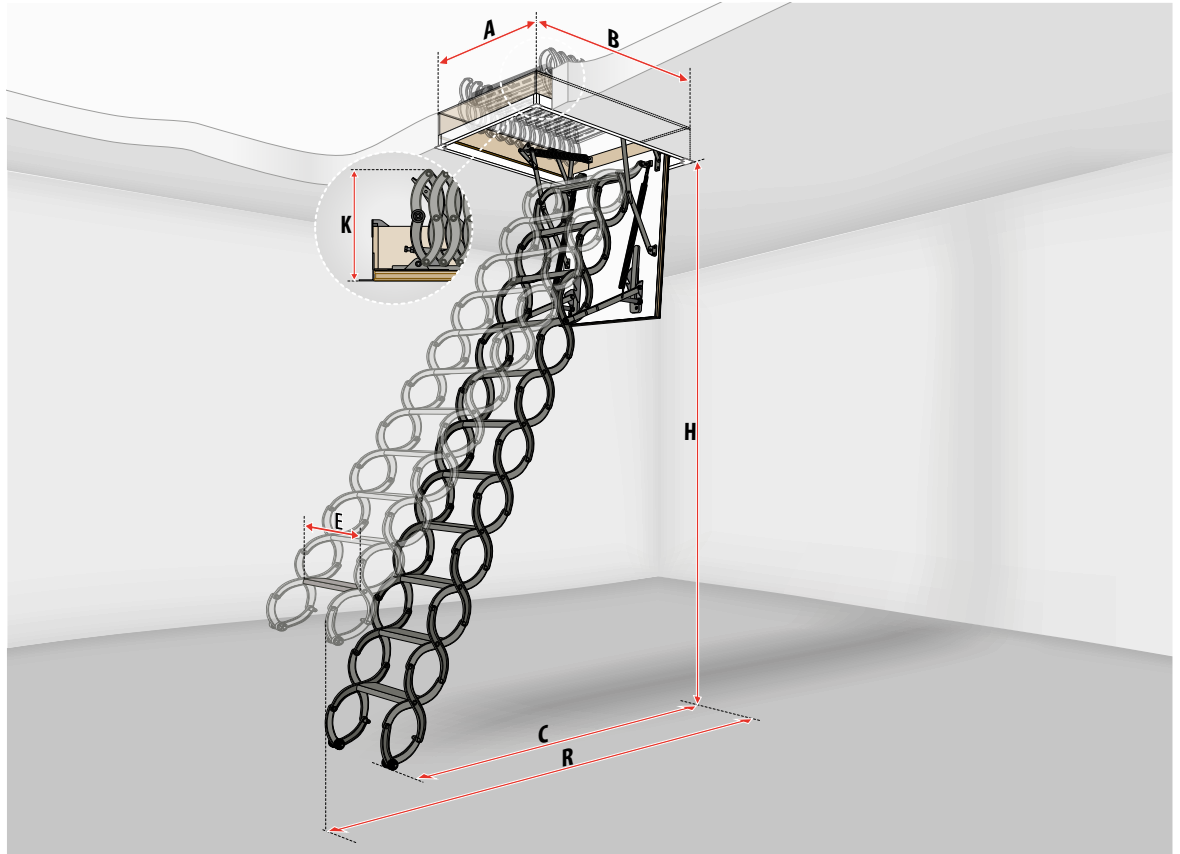

ATTIC LADDER DIMENSIONS

LST		22½"x31½"	27½"x31½"	22½"x47"	25"x47"	22½"x54"	25"x54"	30 ½" x 54"
Manufacturer's part number		66875	66876	66820	66821	66822	66823	66877
Ceiling height	H	8'2¾" – 9'2¼"						
Rough opening	AxB	22½"x31½"	27½"x31½"	22½"x47"	25"x47"	22½"x54"	25"x54"	30 ½"x54"
Outside frame dimensions		22"x31¼"	27"x31¼"	22"x46¾"	24½"x46¾"	22"x53¾"	24½"x53¾"	30"x53¾"
Outside frame dimensions including trim		24¾"x33¼"	29½"x33¼"	24¾"x49"	26¾"x49"	24¾"x55¾"	26¾"x55¾"	31¾"x55 ¾"
Inside frame dimensions		20½"x29¼"	25½"x29¼"	20½"x44¾"	22¾"x44¾"	20½"x51¾"	22¾"x51¾"	28"x51 ¾"
Projection	R	59"						
Landing space	C	57½" – 52¾"						
Folded ladder height	K	15"						
Frame height		7¾"						
Approx. Weight (lbs)		84	92	88	93	97	99	110
Step length	E	11¾"	15"	11¾"				15"
Step width		3½"						
Possibility of adding additional steps		LSS-31	LSS-38	LSS-31			LSS-38	

1 step removed	1 additional step	2 additional steps
7'6½"	8'2¾"	9'2¼"
9'10½"	9'10½"	10'10"
Ladder dimensions are equal to all sizes.		
55½"	63"	67"
53½"	51½"	59"
57½"	63"	59"

Technical specification:
maximum loading: 350 lbs
R-value: 5.2
insulation thickness: 1 ½"
hatch thickness: 1 ¾"

Available only in sizes given above.



MM040126MC