



MILLWORK CATALOG

DOORS

2026 EDITION



TABLE OF CONTENTS

INTERIOR DOORS*

CLEAR PINE	
INTERIORS	11
HOLLOW CORE	
SLABS & BI-FOLDS	6
KNOTTY PINE	
INTERIORS	12
MDF	
SLABS	10
POCKET FRAMES	
INTERIORS	13
PREMIUM POCKET DOORS	
CAVITY SLIDERS	14
SOLID CORE	
SLABS	8

EXTERIOR DOORS*

FIBERGLASS DOORS	
OPAQUE SLABS	18
1 LITE	19
BLINDS	20
EXTERNAL GRIDS	21
INTERNAL GRIDS	22
NOUVEAU	24
TEXAS STAR	25
MISC	26
FLUSH GLAZED (VISTA GRANDE)	28
METAL DOORS	
OPAQUE SLABS	29
1 LITE	30
BLINDS	31
EXTERNAL GRIDS	32
INTERNAL GRIDS	33
NOUVEAU	34
TEXAS STAR	35
MISC	36
WOOD DOORS	
MAHOGANY/KNOTTY ALDER	37

DOOR COMPONENTS*

DOOR COMPONENTS	
DOOR HINGE OPTIONS / VENTS	40
INTERIOR/EXTERIOR JAMBS	41
SILLS	42
SILLS & SILL COMPONENTS	43
PANOLOCK MULTI-POINT LOCK	44
LIGHTEN IN-FRAME LIGHT	46
WOOD DOOR ACCESSORIES / PET DOOR	48

DOOR INFORMATION

SIZES & ROUGH OPENINGS	
INTERIOR DOOR UNITS	50
DOOR HANDING GUIDE	
IN SWING	52
OUT SWING	53
MOLDED DOOR CUTDOWN RANGES	
JELD-WEN	54

PREMIUM INTERIOR DOORS

JELD-WEN	
KARONA® COLLECTIONS	60
ARCHITECTURAL CONCEPTS	
MDF DOORS	68
STILECHOICE	
MDF DOORS	80
MASONITE	
MIRAVISTA FOLDING DOOR SYSTEM	80

GLASSCRAFT®

FIBERCRAFT®	
COMPOSITE DOORS	84
WOODCRAFT®	
HARDWOOD DOORS	86

PATIO DOORS

ATRIUM	
SERIES 312 - SLIDING PATIO DOOR	90
SERIES 332 - SLIDING PATIO DOOR	91
MI WINDOWS & DOORS	
V2000 PATIO DOOR	92
V3000 MULTI-SLIDE PATIO DOOR	94
SHOWCASE	
MULTI-PANEL SLIDING PATIO DOOR	96

PREMIUM PATIO DOORS

BONELLI	
MULTI-SLIDE PATIO DOOR	109
PIVOT PATIO DOOR	107
MI WINDOWS & DOORS	
V3000 MULTI-SLIDE PATIO DOOR	101
MASONITE	
MIRAVISTA FOLDING DOOR	99
NEUMA DOORS	
PATIO DOORS	98
PGT CUSTOM DOORS	
PATIO DOORS	101
WINDOR	
3750 MULTI-SLIDE SYSTEM	100

IRON DOORS

IRON ENVY	
IRON DOORS	112

COMMERCIAL DOORS

TELL	
SPARTAN HOLLOW METAL DOORS	116

ABBREVIATION LEGEND	91
----------------------------------	----

*In stock at the McCoy's Door Shop for quick ship to the McCoy's Store.





DOOR & MILLWORK

INTERIOR DOORS

HOLLOW CORE

SLABS & BI-FOLDS



SLABS

SIZE	THICKNESS	1 PNL MADISON®	2 PNL RND TOP SANTA FE™	2 PNL SQ CARRARA®	2 PNL RND TOP CAIMAN®	2 PNL ARCH CAMDEN®	2 PNL MONROE®	3 PNL BIRKDALE™	3 PNL BEVELED CRAFTSMAN III™	5 PNL ROCKPORT™	6 PNL ROCKPORT™	6 PNL COLONIST®	HARD-BOARD	LAUAN	BIRCH
1'0 X 6'8	1-3/8"		•	•	•	◇		•	•			+	•		
1'10 X 6'8	1-3/8"			•								◇			
1'2 X 6'8	1-3/8"		•	•	•	◇		•				+	•		
1'3 X 6'8	1-3/8"		•	•	•	◇		•				+	•		•
1'4 X 6'8	1-3/8"		•	•	•	◇		•		•		+	•	•	•
1'6 X 6'8	1-3/8"	•	•	•	•	◇	•	•	•	•		+	•	•	•
1'8 X 6'8	1-3/8"		•	•	•	◇				•		+	•	•	•
2'0 X 6'8	1-3/8"	•	•	•	•	◇	•	•	•	•		+	•	•	•
2'4 X 6'8	1-3/8"	•	•	•	•	◇	•	•	•	•		+	•	•	•
2'6 X 6'8	1-3/8"	•	•	•	•	◇	•	•	•	•		+	•	•	•
2'8 X 6'8	1-3/8"	•	•	•	•	◇	•	•	•	•		+	•	•	•
2'10 X 6'8	1-3/8"		•	•		◇						◇		•	
3'0 X 6'8	1-3/8"	•	•	•	•	◇	•	•	•	•		+	•	•	•
1'3 X 8'0	1-3/8"		•												
1'4 X 8'0	1-3/8"		•	•	•						•				
1'6 X 8'0	1-3/8"	•	•	•	•		•	•			•	◇			
1'8 X 8'0	1-3/8"		•												
2'0 X 8'0	1-3/8"	•	•	•	•		•	•			•	◇			
2'4 X 8'0	1-3/8"	•	•	•	•		•	•			•	◇			
2'6 X 8'0	1-3/8"	•	•	•	•		•	•			•	◇			
2'8 X 8'0	1-3/8"	•	•	•	•		•	•			•	◇			
3'0 X 8'0	1-3/8"	•	•	•	•		•	•			•	◇			
2'6 X 6'7	1-3/4"												•		
2'8 X 6'7	1-3/4"												•		
3'0 X 6'7	1-3/4"												•		
2'6 X 7'11	1-3/4"												•		
2'8 X 7'11	1-3/4"												•		
3'0 X 7'11	1-3/4"												•		
3'6 X 7'11	1-3/4"												•		

BI-FOLDS

SIZE	THICKNESS	2 PNL SANTA FE™	2 PNL SQ CARRARA®	2 PNL RND TOP CAIMAN®	2 PNL ARCH CAMDEN®	3 PNL BEVELED CRAFTSMAN III™	6 PNL COLONIST®	HARDBOARD	LAUAN	BIRCH
2'0 X 6'8	1-3/8"	•	•	•	◇	•	+	•	•	•
2'4 X 6'8	1-3/8"						◇			
2'6 X 6'8	1-3/8"	•	•	•	◇	•	+	•	•	•
2'8 X 6'8	1-3/8"		•	•	◇		◇		•	
3'0 X 6'8	1-3/8"	•	•	•	◇	•	+	•	•	•

• SMOOTH OPTION ONLY ◇ TEXTURED OPTION ONLY + BOTH OPTIONS



1 PANEL
MADISON®



2 PANEL ROUND
TOP SANTA FE™



2 PANEL SQUARE
CARRARA®



2 PANEL ROUND
TOP CAIMAN®



2 PANEL ARCH
CAMDEN®



2 PANEL
MONROE®



3 PANEL
BIRKDALE™



3 PANEL BEVELED
CRAFTSMAN III™



5 PANEL
ROCKPORT™



6 PANEL
ROCKPORT™



6 PANEL
COLONIST®



HARDBOARD



LAUAN



BIRCH



2 PANEL BI-FOLD
SANTA FE™



2 PANEL SQUARE
BI-FOLD CARRARA®



2 PANEL ROUND TOP
BI-FOLD CAIMAN®



2 PANEL ARCH
BI-FOLD CAMDEN®



3 PANEL BI-FOLD
BIRKDALE™



3 PANEL BEVELED
BI-FOLD
CRAFTSMAN III™



6 PANEL BI-FOLD
COLONIST®



HARDBOARD
BI-FOLD



LAUAN
BI-FOLD



BIRCH
BI-FOLD

SOLID CORE SLABS



SIZE	THICKNESS	1 PNL MADISON®	2 PNL RND TOP SANTA FE™	2 PNL SQ CARRARA®	2 PNL RND TOP CAIMAN®	2 PNL ARCH CAMDEN®	2 PNL MONROE®	3 PNL BIRKDALE™	3 P FLT/BV CRAFTSMAN III™	5 PNL ROCKPORT™	6 PNL ROCKPORT™	6 PNL COLONIST®	HARD- BOARD	LAUAN	BIRCH
1'0 X 6'8	1-3/8"														
1'10 X 6'8	1-3/8"														
1'2 X 6'8	1-3/8"														
1'3 X 6'8	1-3/8"														
1'4 X 6'8	1-3/8"														
1'6 X 6'8	1-3/8"	•	•	•	•		•			•					
1'8 X 6'8	1-3/8"														
2'0 X 6'8	1-3/8"	•	•	•	•		•			•			•		•
2'4 X 6'8	1-3/8"	•	•	•	•		•			•			•		•
2'6 X 6'8	1-3/8"	•	•	•	•		•			•			•		•
2'8 X 6'7	1-3/4"	•	•	•	•	+	•	•	•	•		•	•	•	•
2'8 X 6'8	1-3/8"	•	•	•	•		•			•			•		•
2'8 X 6'8	1-3/4"													•	
3'0 X 6'7	1-3/4"	•	•	•	•	+	•	•	•	•		•	•	•	•
3'0 X 6'8	1-3/8"	•	•	•	•		•			•			•		•
3'0 X 6'8	1-3/4"													•	
1'3 X 8'0	1-3/8"														
1'4 X 8'0	1-3/8"														
1'6 X 8'0	1-3/8"	•	•	•	•		•	•			•		•		
1'8 X 8'0	1-3/8"														
2'0 X 8'0	1-3/8"	•	•	•	•		•	•			•		•		
2'4 X 8'0	1-3/8"	•	•	•	•		•	•			•		•		
2'6 X 8'0	1-3/8"	•	•	•	•		•	•			•		•		
2'8 X 7'11	1-3/4"	•	•	•	•		•	•			•	•	•		
2'8 X 8'0	1-3/8"	•	•	•	•		•	•			•	•	•		
3'0 X 7'11	1-3/4"	•	•	•	•		•	•			•	•	•		
3'0 X 8'0	1-3/8"	•	•	•	•		•	•			•	•	•		

• SMOOTH OPTION ONLY ◇ TEXTURED OPTION ONLY + BOTH OPTIONS



1 PANEL
MADISON®



2 PANEL ROUND TOP
SANTA FE™



2 PANEL SQUARE
CARRARA®



2 PANEL ROUND TOP
CAIMAN®



2 PANEL ARCH
CAMDEN®



2 PANEL
MONROE®



3 PANEL
BIRKDALE™



3 PANEL BEVELED
CRAFTSMAN III™



5 PANEL
ROCKPORT™



6 PANEL
ROCKPORT™



6 PANEL
COLONIST®

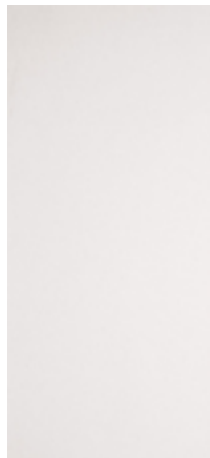

HARDBOARD



LAUAN



BIRCH

MDF SLABS



1 PANEL SHAKER
SMOOTH



2 PANEL SHAKER
SMOOTH



3 PANEL SHAKER
SMOOTH



5 PANEL SHAKER
SMOOTH



6 PANEL SHAKER
SMOOTH

SIZE	THICKNESS	1 PANEL SHAKER SMOOTH	2 PANEL SHAKER SMOOTH	3 PANEL SHAKER SMOOTH	5 PANEL SHAKER SMOOTH	6 PANEL SHAKER SMOOTH
1'0 X 6'8	1-3/8"					
1'10 X 6'8	1-3/8"					
1'2 X 6'8	1-3/8"					
1'3 X 6'8	1-3/8"					
1'4 X 6'8	1-3/8"	•	•		•	
1'6 X 6'8	1-3/8"	•	•	•	•	
1'8 X 6'8	1-3/8"	•	•		•	
2'0 X 6'8	1-3/8"	•	•	•	•	
2'4 X 6'8	1-3/8"	•	•	•	•	
2'6 X 6'8	1-3/8"	•	•	•	•	
2'8 X 6'8	1-3/4"	•	•	•	•	
2'8 X 6'8	1-3/8"	•	•	•	•	
3'0 X 6'8	1-3/4"	•	•	•	•	
3'0 X 6'8	1-3/8"	•	•	•	•	
1'3 X 8'0	1-3/8"					
1'4 X 8'0	1-3/8"	•	•			•
1'6 X 8'0	1-3/8"	•	•	•		•
1'8 X 8'0	1-3/8"					
2'0 X 8'0	1-3/8"	•	•	•		•
2'4 X 8'0	1-3/8"	•	•	•		•
2'6 X 8'0	1-3/8"	•	•	•		•
2'8 X 8'0	1-3/4"	•	•	•		•
2'8 X 8'0	1-3/8"	•	•	•		•
3'0 X 8'0	1-3/4"	•	•	•		•
3'0 X 8'0	1-3/8"	•	•	•		•



1 LITE 5 LITE 6 LITE 10 LITE 12 LITE 15 LITE 18 LITE



6 PANEL LOUVER / LOUVER PANTRY FULLVIEW PANTRY 3/4 VIEW

SIZE	THICKNESS	1 LITE	5 LITE	6 LITE	10 LITE	12 LITE	15 LITE	18 LITE	6 PANEL	LVR/LVR	PANTRY FULL	PANTRY 3/4 VIEW
1'6 X 6'8	1-3/8"		•						•			
1'8 X 6'8	1-3/8"											
2'0 X 6'8	1-3/8"	•			•				•	•	•	
2'4 X 6'8	1-3/8"						•		•	•	•	
2'6 X 6'8	1-3/8"	•					•		•	•	•	
2'8 X 6'8	1-3/8"	•					•		•	•		
3'0 X 6'8	1-3/8"	•					•		•	•	•	
1'6 X 8'0	1-3/8"			•								
1'8 X 8'0	1-3/8"											
2'0 X 8'0	1-3/8"	•				•						•
2'4 X 8'0	1-3/8"					•						
2'6 X 8'0	1-3/8"	•						•				
2'8 X 8'0	1-3/8"	•						•				
3'0 X 8'0	1-3/8"	•						•				

KNOTTY PINE & KNOTTY ALDER INTERIORS



6 PANEL



2 PANEL ROUND TOP
V-GROOVE



2 PANEL SQUARE TOP
V-GROOVE



BARN - Z



BARN - X

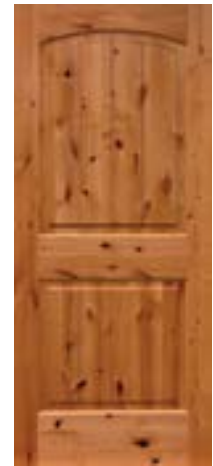

2 PANEL ROUND TOP
V-GROOVE

KNOTTY PINE							KNOTTY ALDER
SIZE	THICKNESS	6 PANEL	2 PANEL ROUND TOP V-GROOVE	2 PANEL SQUARE TOP V-GROOVE	BARN - Z	BARN - X	2 PANEL ROUND TOP V-GROOVE
1'6 X 6'8	1-3/8"						•
1'8 X 6'8	1-3/8"						
2'0 X 6'8	1-3/8"	•	•	•			•
2'4 X 6'8	1-3/8"	•	•	•			•
2'6 X 6'8	1-3/8"	•	•	•			•
2'8 X 6'8	1-3/8"	•	•	•			•
3'0 X 6'8	1-3/8"	•	•	•			•
1'6 X 8'0	1-3/8"						•
1'8 X 8'0	1-3/8"						•
2'0 X 8'0	1-3/8"						•
2'4 X 8'0	1-3/8"						•
2'6 X 8'0	1-3/8"						•
2'8 X 8'0	1-3/8"						•
3'0 X 8'0	1-3/8"						•
2'8 X 6'8	1-3/4"	•	•	•			
3'0 X 6'8	1-3/4"	•	•	•			
2'8 X 8'0	1-3/4"		•	•			
3'0 X 8'0	1-3/4"		•	•			
2'8 X 7'0	1-3/8"				•	•	
3'0 X 7'0	1-3/8"				•	•	
3'6 X 7'0	1-3/8"				•	•	



**POCKET FRAME
COMPONENT**



**POCKET FRAME
COMPONENT INSTALLED**

ROUGH OPENINGS	
2068	50-1/2 X 83-7/8
2468	58-1/2 X 83-7/8
2668	62-1/2 X 83-7/8
2868	66-1/2 X 83-7/8
3068	74-1/2 X 83-7/8
2080	50-1/2 X 99-7/8
2480	58-1/2 X 99-7/8
2680	62-1/2 X 99-7/8
2880	66-1/2 X 99-7/8
3080	74-1/2 X 99-7/8

* SOFT CLOSING HARDWARE AVAILABLE AND SOLD SEPARATELY

* SOLID PINE FRAME FOR 2X4 WALLS

* 4-9/16" FJ JAMB FOR 2X4 WALLS

* 6-9/16" FJ JAMB FOR 2X6 WALLS

CAVITY SLIDERS (SPECIAL ORDER)

PREMIUM POCKET DOOR



The Premium Pocket Door Solution



CS Track Systems and Hardware for Sliding Doors

CS TopMountTrack

Low profile track system suitable for incorporating into pocket door frame assemblies.



Design Features & Options

- Track is made from high-quality, heavy duty extruded aluminum
- Track is notched for simple carriage insertion
- Track can be configured to suit bi-parting or corner meeting door setups
- Double and triple tracks are available for custom orders
- Compatible with standard and soft close carriages



CL400® Magnetic

Patented magnetic pocket door handle that features a magnetic catch and plunger system.



Design Features & Options

- Configurations include Passage, Privacy, Key Locking, Bi-Parting
- Design ensures that the doors slides flush back into the pocket
- Suitable for doors 1-3/8" and 1-3/4" thick
- Available in five standard finishes



Bright Chrome



Satin Chrome



Oil Rubbed Bronze



Satin Nickel



Matte Black

Pocket Frame Systems

The CS Cavity Slider™ is a practical solution for those areas where there is not enough space for a swinging door.

In addition to its space saving attributes in restrooms, hallways, and laundries, it can be used with confidence for architectural feature openings around your project.

Features

- Structurally robust due to its construction from aluminum extrusions
- Easy to assemble and install
- Available for 2x4 and 2x6 framing
- Can be cut down to size on site
- Suitable for residential and commercial projects (meets Type 1 construction code without any combustible materials)

Rough Opening

DH - Door Height DW - Door Width

Dimension	Inches
RO Height	DH + 4-1/4"
RO Width Single	(DW x 2) + 2"
RO Width Bi-Parting	(DW x 4) + 2"

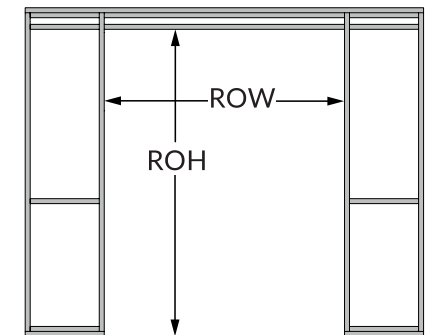

How to Order

1. Choose Framing and Door Size

Frames can be cut down on site to maximize size for each model:

Framing	Door Size	Product SKU
4" Framing (2x4 Stud)	2'0" x 6'8"	CSS4K2068
	2'6" x 6'8"	CSS4K2668
	2'8" x 6'8"	CSS4K2868
	3'0" x 6'8"	CSS4K3068
	2'6" x 8'0"	CSS4K2680
	2'8" x 8'0"	CSS4K2880
	3'0" x 8'0"	CSS4K3080
	4'0" x 8'0"	CSS4K4080
	2'6" x 8'0"	CSU6K2680
	3'0" x 8'0"	CSU6K3080
6" Framing (2x6 Stud)	4'0" x 8'0"	CSU6K4080
	3'0" x 9'0"	CSU6K3090
	4'0" x 9'0"	CSU6K4090
	3'0" x 10'0"	CSU6K30100
	4'0" x 10'0"	CSU6K40100
	5'0" x 10'0"	CSU6K50100

2. Choose a Carriage Pack (one per door)

Includes: Carriages, mounting plates, T-Guide, fixing screws, and adjusting wrench

Carriage Pack Type	Product SKU
Standard M6 (200lb/90kg)	CSDKM0611
Standard M8 (500lb/240kg)	CSDKM0811
CS SofStop Single Action Door Weight: 0-200 lb (90kg) Min Door Width 1 Stop: 26" (660mm)	CSDKS0511
CS SofStop Twin Action Door Weight: 0-200 lb (90kg) Min Door Width 1 Stop: 26" (660mm)	CSDKS0711
CS SofStop HD Twin Action Door Weight: 0-350 lb (160kg) Min Door Width 1 Stop: 29" (737mm)	CSDKS0811

CAVITY SLIDERS (SPECIAL ORDER)

PREMIUM POCKET DOOR



CS Cavity Slider™ Features



Smooth running carriages
with encased ball bearings.
Up to 500lb (240kg) capacity

SofStop Soft Close/Soft Open
also available



Corner joining brackets
ensure precise right angled
assembly



T-joining brackets
for easy assembly of
slats to split jambs &
back stud

Horizontal slats
for added
strength

**Strong aluminum
frame** complies
with Type 1
Construction

**Split Jambs
and slats** use
hollow core
technology for
superior rigidity

Door Thickness

1-3/8" to 1-3/4"
2x4 Stud

1-3/8" to 2-1/4"
2x6 Stud

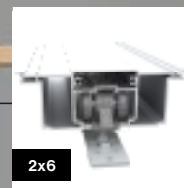

**Extruded aluminum
track** incorporated into
head unit



Trim Clips for quick
& easy trim fitting

Compatible with
4" and 6" stud
sizes

**Bottom plate
assembly**



**Adjustable
T-Guide**

Patent Pending



**Cycle tested
1 million openings**



ADA Compliant



**Available with
SofStop™**



**Single or
Bi-Parting units**



**Maximum door
weight**

Instructions/
Instrucciones





DOOR & MILLWORK

EXTERIOR DOORS

FIBERGLASS DOORS

OPAQUE SLABS

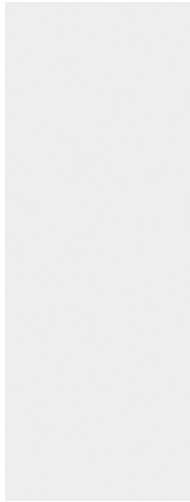

FLUSH

*SMOOTH, TEXTURED



2 PANEL SQUARE

*SMOOTH



2 PANEL CHEYENNE

*SMOOTH, TEXTURED



6 PANEL

*SMOOTH, TEXTURED

Smooth are white, ready for paint. Textured are tan oak grain, ready for finish. Mahogany grain ready for finish.

*AVAILABLE OPTIONS

MATERIAL	SIZE	FLUSH	2 PANEL SQUARE	2 PANEL CHEYENNE	6 PANEL
FIBERGLASS	2'0 X 6'8	◇			
FIBERGLASS	2'6 X 6'8	•			◇
FIBERGLASS	2'8 X 6'8	•	•	•	•
FIBERGLASS	2'10X6'5				
FIBERGLASS	3'0 X 6'8	•	•	•	•
FIBERGLASS SIDELITE	1'2 X 6'8				
FIBERGLASS SIDELITE	1'0 X 6'8				
FIBERGLASS	2'6 X 8'0	◇			
FIBERGLASS	2'8 X 8'0	•		•	•
FIBERGLASS	3'0 X 8'0	•	•	•	•
FIBERGLASS SIDELITE	1'0 X 8'0				

◇ TEXTURED OPTION ONLY

SEE PAGE 48 FOR SINGLE, DOUBLE, SIDELITE AND PATIO CONFIGURATIONS



FAN LITE
*SMOOTH, TEXTURED

1 LITE SPOTLIGHT
*SMOOTH, TEXTURED

2 LITE SQUARE SPOTLIGHT
*SMOOTH, TEXTURED

4 LITE HORIZONTAL SPOTLIGHT
*SMOOTH, TEXTURED

5 LITE HORIZONTAL SPOTLIGHT
*SMOOTH, TEXTURED

HALFVIEW
*SMOOTH, TEXTURED

HALFVIEW CHEYENNE
*SMOOTH

HALFVIEW VENT LITE
*SMOOTH, TEXTURED



HALF VIEW VENT LITE CHEYENNE
*SMOOTH

3/4 VIEW MAHOGANY
*TEXTURED

3/4 VIEW
*SMOOTH

FULLVIEW
*SMOOTH, TEXTURED

FULL OVAL
*SMOOTH, TEXTURED

SIDELITE HALFVIEW
*SMOOTH, TEXTURED

SIDELITE 3/4V
*SMOOTH, TEXTURED

SIDELITE FULLVIEW
*SMOOTH, TEXTURED

Smooth are white, ready for paint. Textured are tan oak grain, ready for finish. Mahogany grain ready for finish.

*AVAILABLE OPTIONS

MATERIAL	SIZE	GLASS	FAN LITE	1 LITE SPOT LITE	2 LITE SQ SPOT LITE	4 LITE HORIZ SPOT LITE	5 LITE HORIZ SPOT LITE	HV	HV CHEYENNE	HV VENT LITE	HV VENT LITE CHEYENNE	3/4 VIEW MAHOGANY	3/4 VIEW	FULL VIEW	FULL OVAL	SL HV	SL 3/4V	SL FV
FIBERGLASS	2'0" X 6'8"	1-3/4"												◇				
FIBERGLASS	2'6" X 6'8"	1-3/4"			◇			◇						•				
FIBERGLASS	2'8" X 6'8"	1-3/4"	◇	◇	•	•	•	•	•	•	•			•	•			
FIBERGLASS	2'10" X 6'5"	1-3/4"												•				
FIBERGLASS	3'0" X 6'8"	1-3/4"	•	•	•	•	•	•	•	•	•	◇	•	•	•			
FIBERGLASS SIDELITE	1'2" X 6'8"	1-3/4"														•	•	•
FIBERGLASS SIDELITE	1'0" X 6'8"	1-3/4"														•	•	•
FIBERGLASS	2'6" X 8'0"	1-3/4"												•				
FIBERGLASS	2'8" X 8'0"	1-3/4"		•	•	•	•	•	•					•				
FIBERGLASS	3'0" X 8'0"	1-3/4"		•	•	•	•	•	•			◇	•	•				
FIBERGLASS SIDELITE	1'0" X 8'0"	1-3/4"														◇	◇	

◇ TEXTURED OPTION ONLY

SEE PAGE 48 FOR SINGLE, DOUBLE, SIDELITE AND PATIO CONFIGURATIONS

FIBERGLASS DOORS

BLINDS



**HALFVIEW
MINIBLIND**

*SMOOTH, TEXTURED

**HALFVIEW
MINIBLIND
CHEYENNE**

*SMOOTH

**3/4 VIEW
MINIBLIND**

*SMOOTH

**3/4 VIEW
MINIBLIND
MAHOGANY**

*TEXTURED

**FULLVIEW
MINIBLIND**

*SMOOTH, TEXTURED

**15 LITE
FULLVIEW
MINIBLIND**

*SMOOTH, TEXTURED

Smooth are white, ready for paint. Textured are tan oak grain, ready for finish. Mahogany grain ready for finish.

*AVAILABLE OPTIONS

MATERIAL	SIZE	GLASS	HALFVIEW MINIBLIND	HALFVIEW MINIBLIND CHEYENNE	3/4 VIEW MINIBLIND	3/4 VIEW MINIBLIND MAHOGANY	FULLVIEW MINIBLIND	15 LITE FULLVIEW MINIBLIND
FIBERGLASS	2'0 X 6'8	1-3/4"						
FIBERGLASS	2'6 X 6'8	1-3/4"					•	•
FIBERGLASS	2'8 X 6'8	1-3/4"	•	•			•	•
FIBERGLASS	2'10X6'5	1-3/4"					•	•
FIBERGLASS	3'0 X 6'8	1-3/4"	•	•	•	◇	•	•
FIBERGLASS SIDELITE	1'2 X 6'8	1-3/4"						
FIBERGLASS SIDELITE	1'0 X 6'8	1-3/4"						
FIBERGLASS	2'6 X 8'0	1-3/4"						
FIBERGLASS	2'8 X 8'0	1-3/4"	•				•	
FIBERGLASS	3'0 X 8'0	1-3/4"	•		•	◇	•	
FIBERGLASS SIDELITE	1'0 X 8'0	1-3/4"						

◇ TEXTURED OPTION ONLY

SEE PAGE 48 FOR SINGLE, DOUBLE, SIDELITE AND PATIO CONFIGURATIONS



Smooth are white, ready for paint. Textured are tan oak grain, ready for finish. Mahogany grain ready for finish.

*AVAILABLE OPTIONS

MATERIAL	SIZE	GLASS	FAN LITE	6 LITE FLUSH GLAZED CRAFTSMAN	9 LITE HALF VIEW	9 LITE HV CHEYENNE	12 LITE HV 8'	12 LITE 3/4 VIEW	12 LITE 3/4 VIEW 8' MAHOGANY	15 LITE 3/4 VIEW 8'	15 LITE 3/4 VIEW MAHOGANY	10 LITE FV	15 LITE FV	SL 3 LITE HV	SL 4 LITE 3/4 V	SL 5 LITE FV
FIBERGLASS	2'0 X 6'8	1-3/4"										◇	◇			
FIBERGLASS	2'6 X 6'8	1-3/4"										•	•			
FIBERGLASS	2'8 X 6'8	1-3/4"	◇		•	•						•	•			
FIBERGLASS	2'10X6'5	1-3/4"										•	•			
FIBERGLASS	3'0 X 6'8	1-3/4"	•	•	•	•		•	•			•	•			
FIBERGLASS SIDELITE	1'2 X 6'8	1-3/4"												•	•	•
FIBERGLASS SIDELITE	1'0 X 6'8	1-3/4"												•	•	•
FIBERGLASS	2'6 X 8'0	1-3/4"														
FIBERGLASS	2'8 X 8'0	1-3/4"					•									
FIBERGLASS	3'0 X 8'0	1-3/4"		•			•			•	•					
FIBERGLASS SIDELITE	1'0 X 8'0	1-3/4"												+	±	

◇ TEXTURED OPTION ONLY

+ 1080 HV AVAILABLE IN 4LT

± 1080 3/4 V AVAILABLE IN 5LT

SEE PAGE 48 FOR SINGLE, DOUBLE, SIDELITE AND PATIO CONFIGURATIONS

FIBERGLASS DOORS

INTERNAL GRIDS



5 LITE FAN LITE
*SMOOTH, TEXTURED



9 LITE HALFVIEW
*SMOOTH



9 LITE HALFVIEW CHEYENNE
*SMOOTH



9 LITE (BRONZE) HALFVIEW
*SMOOTH, TEXTURED



9 LITE (BRONZE) HALFVIEW CHEYENNE
*SMOOTH



12 LITE HALFVIEW
*SMOOTH, TEXTURED



12 LITE 3/4 VIEW MAHOGANY
*TEXTURED



15 LITE 3/4 VIEW
*SMOOTH



15 LITE 3/4 VIEW MAHOGANY 8'
*TEXTURED

Smooth are white, ready for paint. Textured are tan oak grain, ready for finish. Mahogany grain ready for finish.

*AVAILABLE OPTIONS

MATERIAL	SIZE	GLASS	5 LITE FAN LITE	9 LITE HV	9 LITE HV CHEYENNE	9 LITE (BRONZE) HALFVIEW	9 LITE (BRONZE) HALFVIEW CHEYENNE	12 LITE HALFVIEW	12 LITE 3/4 VIEW MAHOGANY	12 LITE 3/4 VIEW	15 LITE 3/4 VIEW MAHOGANY
FIBERGLASS	2'0 X 6'8	1-3/4"									
FIBERGLASS	2'6 X 6'8	1-3/4"									
FIBERGLASS	2'8 X 6'8	1-3/4"	◇	•	•	•	•				
FIBERGLASS	2'10X6'5	1-3/4"									
FIBERGLASS	3'0 X 6'8	1-3/4"	•	•	•	•	•		◇	•	
FIBERGLASS SIDELITE	1'2 X 6'8	1-3/4"									
FIBERGLASS SIDELITE	1'0 X 6'8	1-3/4"									
FIBERGLASS	2'6 X 8'0	1-3/4"									
FIBERGLASS	2'8 X 8'0	1-3/4"						•			
FIBERGLASS	3'0 X 8'0	1-3/4"						•			◇
FIBERGLASS SIDELITE	1'0 X 8'0	1-3/4"									

SEE PAGE 48 FOR SINGLE, DOUBLE, SIDELITE AND PATIO CONFIGURATIONS

◇ TEXTURED OPTION ONLY

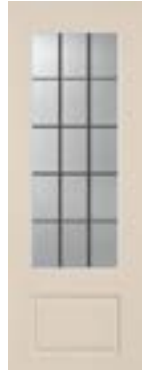

15 LITE (BRONZE) 3/4 VIEW MAHOGANY 8'
*TEXTURED



15 LITE 3/4 VIEW 8'
*SMOOTH

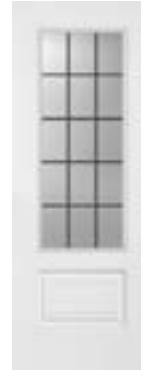

15 LITE (BRONZE) 3/4 VIEW 8'
*SMOOTH



10 LITE FULLVIEW
*SMOOTH, TEXTURED



15 LITE FULLVIEW
*SMOOTH, TEXTURED



15 LITE (BRONZE) FULLVIEW
*SMOOTH, TEXTURED



SIDELITE 3 LITE HALFVIEW
*SMOOTH, TEXTURED



SIDELITE 5 LITE FULLVIEW
*SMOOTH, TEXTURED

Smooth are white, ready for paint. Textured are tan oak grain, ready for finish. Mahogany grain ready for finish.

*AVAILABLE OPTIONS

MATERIAL	SIZE	GLASS	15 LITE (BRONZE) 3/4 VIEW MAHOGANY 8'	15 LITE 3/4 VIEW 8'	15 LITE (BRONZE) 3/4 VIEW 8'	10 LITE FULLVIEW	15 LITE FULLVIEW	15 LITE (BRONZE) FULLVIEW	SIDELITE 3 LITE HV	SIDELITE 5 LITE FV
FIBERGLASS	2'0 X 6'8	1-3/4"								
FIBERGLASS	2'6 X 6'8	1-3/4"								
FIBERGLASS	2'8 X 6'8	1-3/4"				•	•	•		
FIBERGLASS	2'10 X 6'5	1-3/4"				•	•	•		
FIBERGLASS	3'0 X 6'8	1-3/4"				•	•	•		
FIBERGLASS SIDELITE	1'2 X 6'8	1-3/4"							◇	◇
FIBERGLASS SIDELITE	1'0 X 6'8	1-3/4"							•	•
FIBERGLASS	2'6 X 8'0	1-3/4"								
FIBERGLASS	2'8 X 8'0	1-3/4"								
FIBERGLASS	3'0 X 8'0	1-3/4"	•	•	•					
FIBERGLASS SIDELITE	1'0 X 8'0	1-3/4"								

SEE PAGE 48 FOR SINGLE, DOUBLE, SIDELITE AND PATIO CONFIGURATIONS

◇ TEXTURED OPTION ONLY

FIBERGLASS DOORS

NOUVEAU



FAN LITE

*SMOOTH, TEXTURED
±NICKEL, PATINA



HALFVIEW

*SMOOTH, TEXTURED
±NICKEL, PATINA, BRASS



**HALFVIEW
CHEYENNE**

*SMOOTH
±NICKEL, PATINA, BRASS



HALFVIEW 8'

*SMOOTH, TEXTURED
±NICKEL, PATINA, BRASS



3/4 VIEW

*SMOOTH
±NICKEL, PATINA, BRASS



**3/4 VIEW
MAHOGANY**

*TEXTURED
±NICKEL, PATINA, BRASS



**3/4 OVAL
MAHOGANY**

*TEXTURED
±NICKEL, PATINA



FULL OVAL

*SMOOTH
±BRASS

*AVAILABLE OPTIONS
± AVAILABLE FINISHES

Smooth are white, ready for paint. Textured are tan oak grain, ready for finish. Mahogany grain ready for finish.

MATERIAL	SIZE	GLASS	FAN LITE	HALF VIEW	HALFVIEW CHEYENNE	3/4 VIEW	3/4 VIEW MAHOGANY	3/4 OVAL MAHOGANY	FULL OVAL
FIBERGLASS	2'0 X 6'8	1-3/4"							
FIBERGLASS	2'6 X 6'8	1-3/4"							
FIBERGLASS	2'8 X 6'8	1-3/4"	◊	•	•				•
FIBERGLASS	2'10 X 6'5	1-3/4"							
FIBERGLASS	3'0 X 6'8	1-3/4"	•	•	•	•	◊	◊	•
FIBERGLASS SIDELITE	1'2 X 6'8	1-3/4"							
FIBERGLASS SIDELITE	1'0 X 6'8	1-3/4"							
FIBERGLASS	2'6 X 8'0	1-3/4"							
FIBERGLASS	2'8 X 8'0	1-3/4"		•					
FIBERGLASS	3'0 X 8'0	1-3/4"		•					
FIBERGLASS SIDELITE	1'0 X 8'0	1-3/4"							

◊ TEXTURED OPTION ONLY

+ NICKEL OPTION ONLY

SEE PAGE 48 FOR SINGLE, DOUBLE, SIDELITE AND PATIO CONFIGURATIONS



HALFVIEW
*SMOOTH, TEXTURED
±NICKEL, PATINA, IRON



HALFVIEW CHEYENNE
*SMOOTH
±NICKEL, PATINA, IRON



3/4 OVAL MAHOGANY
*TEXTURED
±NICKEL, PATINA



3/4 VIEW
*SMOOTH
±NICKEL, PATINA, IRON



3/4 VIEW MAHOGANY
*TEXTURED
±NICKEL, PATINA, IRON



FULLVIEW
*SMOOTH, TEXTURED
±NICKEL, PATINA, IRON



SIDELITE HALFVIEW
*SMOOTH, TEXTURED
±IRON
8'0 OPTION INCLUDES PATINA



SIDELITE 3/4 VIEW
*SMOOTH, TEXTURED
±NICKEL, PATINA, IRON



SIDELITE FULLVIEW
*SMOOTH, TEXTURED
±PATINA, IRON

*AVAILABLE OPTIONS
± AVAILABLE FINISHES

Smooth are white, ready for paint. Textured are tan oak grain, ready for finish. Mahogany grain ready for finish.

MATERIAL	SIZE	GLASS	HALF VIEW	HALFVIEW CHEYENNE	3/4 OVAL MAHOGANY	3/4 VIEW	3/4 VIEW MAHOGANY	FULL VIEW	SIDELITE HALF VIEW	SIDELITE 3/4 VIEW	SIDELITE FULL VIEW
FIBERGLASS	2'0 X 6'8	1-3/4"									
FIBERGLASS	2'6 X 6'8	1-3/4"									
FIBERGLASS	2'8 X 6'8	1-3/4"	•	•				•			
FIBERGLASS	2'10X6'5	1-3/4"						•			
FIBERGLASS	3'0 X 6'8	1-3/4"	•	•	•	•	•	•			
FIBERGLASS SIDELITE	1'2 X 6'8	1-3/4"							•	•	•
FIBERGLASS SIDELITE	1'0 X 6'8	1-3/4"							•	•	•
FIBERGLASS	2'6 X 8'0	1-3/4"									
FIBERGLASS	2'8 X 8'0	1-3/4"	•								
FIBERGLASS	3'0 X 8'0	1-3/4"	•			•	◊				
FIBERGLASS SIDELITE	1'0 X 8'0	1-3/4"							•	•	

◊ TEXTURED OPTION ONLY

SEE PAGE 48 FOR SINGLE, DOUBLE, SIDELITE AND PATIO CONFIGURATIONS

FIBERGLASS DOORS

MISC



**HALFVIEW
COURTYARD 8'**
*SMOOTH, TEXTURED
±IRON



**3/4 VIEW
COURTYARD**
*SMOOTH
±IRON



**3/4 VIEW COURTYARD
MAHOGANY**
*TEXTURED
±IRON



**HALFVIEW
GRACE 8'**
*SMOOTH, TEXTURED
±NICKEL



3/4 VIEW GRACE
*SMOOTH
±NICKEL



**3/4 VIEW GRACE
MAHOGANY**
*TEXTURED
±NICKEL



**HALFVIEW
JACINTO 8'**
*SMOOTH, TEXTURED
±IRON



**3/4 VIEW
JACINTO**
*SMOOTH
±IRON



**3/4 VIEW
JACINTO MAHOGANY**
*TEXTURED
±IRON



**HALFVIEW
ELEMENT**
*SMOOTH, TEXTURED
±PATINA

Smooth are white, ready for paint. Textured are tan oak grain, ready for finish. Mahogany grain ready for finish.

MATERIAL	SIZE	GLASS	HALFVIEW COURTYARD 8'	3/4 VIEW COURTYARD MAHOGANY	3/4 VIEW COURTYARD	HALF VIEW GRACE 8'	3/4 VIEW GRACE MAHOGANY	3/4 VIEW GRACE	HALF VIEW JACINTO	3/4 VIEW JACINTO	3/4 VIEW JACINTO MAHOGANY	HALF VIEW ELEMENT
FIBERGLASS	2'0 X 6'8	1-3/4"										
FIBERGLASS	2'6 X 6'8	1-3/4"										
FIBERGLASS	2'8 X 6'8	1-3/4"										•
FIBERGLASS	2'10X6'5	1-3/4"										
FIBERGLASS	3'0 X 6'8	1-3/4"		•	•		•	•		•	•	•
FIBERGLASS SIDELITE	1'2 X 6'8	1-3/4"										
FIBERGLASS SIDELITE	1'0 X 6'8	1-3/4"										
FIBERGLASS	2'6 X 8'0	1-3/4"										
FIBERGLASS	2'8 X 8'0	1-3/4"	•			•			•			
FIBERGLASS	3'0 X 8'0	1-3/4"	•			•			•			
FIBERGLASS SIDELITE	1'0 X 8'0	1-3/4"										

SEE PAGE 48 FOR SINGLE, DOUBLE, SIDELITE AND PATIO CONFIGURATIONS



**HALFVIEW
ELEMENT CHEYENNE**
*SMOOTH
±PATINA



**HALFVIEW
GEORGIAN**
*SMOOTH, TEXTURED
±NICKEL



**HALFVIEW GEORGIAN
CHEYENNE**
*SMOOTH
±NICKEL



**HALFVIEW
MAJESTIC**
*SMOOTH, TEXTURED
±NICKEL



**HALFVIEW MAJESTIC
CHEYENNE**
*SMOOTH
±NICKEL



**FULL OVAL
HEIRLOOM**
*SMOOTH, TEXTURED
±NICKEL



**FULLVIEW
HEIRLOOM**
*SMOOTH, TEXTURED
±NICKEL



**3/4 VIEW
HEIRLOOM 8'**
*SMOOTH
±NICKEL



**3/4 VIEW HEIRLOOM
MAHOGANY 8'**
*TEXTURED
±NICKEL

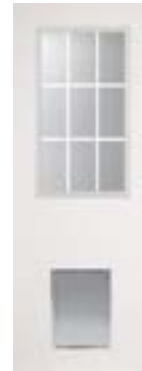

**9 LITE HALFVIEW
PET DOOR°**
*SMOOTH
±NICKEL

° SEE PAGE 48
*AVAILABLE OPTIONS
± AVAILABLE FINISHES

Smooth are white, ready for paint. Textured are tan oak grain, ready for finish. Mahogany grain ready for finish.

MATERIAL	SIZE	GLASS	HALFVIEW ELEMENT CHEYENNE	HALFVIEW GEORGIAN	HALFVIEW GEORGIAN CHEYENNE	HALFVIEW MAJESTIC	HALFVIEW MAJESTIC CHEYENNE	FULL OVAL HEIRLOOM	FULLVIEW HEIRLOOM	3/4 VIEW HEIRLOOM 8'	3/4 VIEW HEIRLOOM MAHOGANY 8'	9 LITE HALFVIEW PET DOOR
FIBERGLASS	2'0 X 6'8	1-3/4"										
FIBERGLASS	2'6 X 6'8	1-3/4"										•
FIBERGLASS	2'8 X 6'8	1-3/4"	•	•	•	•	•	•	•			•
FIBERGLASS	2'10 X 6'5	1-3/4"										•
FIBERGLASS	3'0 X 6'8	1-3/4"	•	•	•	•	•	•	•			•
FIBERGLASS SIDELITE	1'2 X 6'8	1-3/4"										
FIBERGLASS SIDELITE	1'0 X 6'8	1-3/4"										
FIBERGLASS	2'6 X 8'0	1-3/4"										
FIBERGLASS	2'8 X 8'0	1-3/4"										
FIBERGLASS	3'0 X 8'0	1-3/4"								•	•	•
FIBERGLASS SIDELITE	1'0 X 8'0	1-3/4"										

SEE PAGE 48 FOR SINGLE, DOUBLE, SIDELITE AND PATIO CONFIGURATIONS

FIBERGLASS DOORS

FLUSH GLAZED (VISTA GRANDE)

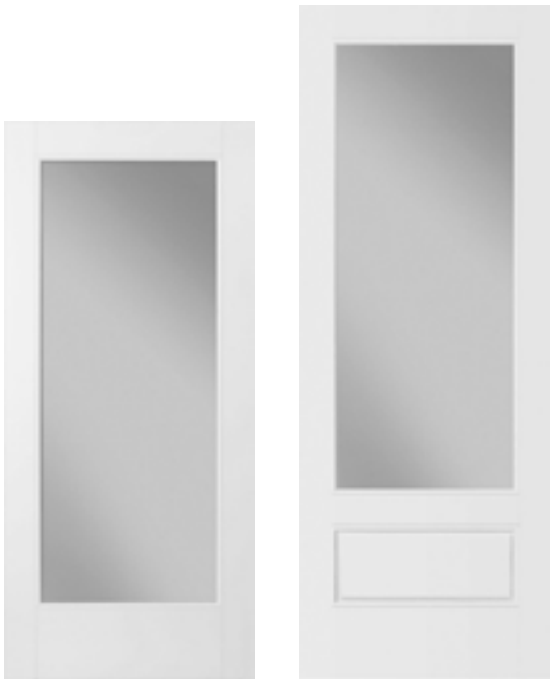

**FULL VIEW
VISTA GRANDE**

**3/4 VIEW
VISTA GRANDE**



CLEAR LOW-E



**DOUBLE WATER
LOW-E**



**SDL RAILS
AVAILABLE IN
1-1/8", 3-1/2" & 5-1/2"**

MATERIAL	SIZE	GLASS	FULL VIEW	3/4 VIEW
CLEAR LOW-E	2'8 X 6'8	1-3/4"	•	
CLEAR LOW-E	3'0 X 6'8	1-3/4"	•	•
CLEAR LOW-E	2'8 X 8'0	1-3/4"	•	
CLEAR LOW-E	3'0 X 8'0	1-3/4"	•	•
DOUBLE WATER	3'0 X 6'8	1-3/4"	•	•
DOUBLE WATER	3'0 X 8'0	1-3/4"	•	•

DIVIDED LITE CONFIGURATIONS

SDL BARS 8/0

SDL BARS 6/8

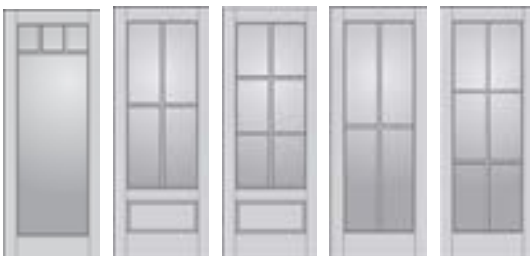

SEE PAGE 48 FOR SINGLE, DOUBLE, SIDELITE AND PATIO CONFIGURATIONS



**FLUSH
NO BORE**

**2 PANEL
CAMBER PLANK**

**2 PANEL
CAMBER TOP**

**3 PANEL
CRAFTSMAN**

**4 PANEL
BLANK TOP**

6 PANEL

MATERIAL	SIZE	FLUSH NO BORE	2 PANEL CAMBER PLANK	2 PANEL CAMBER TOP	3 PANEL CRAFTSMAN	4 PANEL BLANK TOP	6 PANEL
STEEL	2'0 X 6'8	•					
STEEL	2'4 X 6'8	•					
STEEL	2'6 X 6'8	•					•
STEEL	2'8 X 6'8	•	•	•	•	•	•
STEEL	2'10 X 6'8	•					•
STEEL	2'10X6'5						
STEEL	3'0 X 6'8	•	•	•	•	•	•
STEEL	3'6 X 6'8	•					
STEEL SIDELITE	1'2 X 6'8	•					
STEEL SIDELITE	1'0 X 6'8	•					
STEEL	2'0 X 8'0	•					
STEEL	2'6 X 8'0	•					
STEEL	2'8 X 8'0	•					•
STEEL	3'0 X 8'0	•					•

SEE PAGE 48 FOR SINGLE, DOUBLE, SIDELITE AND PATIO CONFIGURATIONS

METAL DOORS

1 LITE



FAN LITE 1 LITE SPOTLIGHT 2 LITE SQUARE SPOTLIGHT 4 LITE HORIZONTAL SPOTLIGHT 5 LITE HORIZONTAL SPOTLIGHT HALFVIEW VENT LITE



3/4 VIEW FULL VIEW FULL OVAL SIDELITE HALFVIEW SIDELITE 3/4 VIEW SL FV FLUSH

MATERIAL	SIZE	FAN LITE	1 LITE SPOT LIGHT	2 LITE SQUARE SPOTLIGHT	4 LITE HORIZ SPOTLIGHT	5 LITE HORIZ SPOTLIGHT	HALF VIEW	VENT LITE	3/4 VIEW	FULL VIEW	FULL OVAL	SIDELITE HV	SIDELITE 3/4 VIEW	SIDELITE FV
STEEL	2'0 X 6'8									•				
STEEL	2'4 X 6'8									•				
STEEL	2'6 X 6'8		•	•						•				
STEEL	2'8 X 6'8	•	•	•	•	•	•	•	•	•	•			
STEEL	2'10 X 6'8		•	•	•	•				•	•			
STEEL	2'10X6'5									•				
STEEL	3'0 X 6'8	•	•	•	•	•	•	•	•	•	•			
STEEL	3'6 X 6'8									•	•			
STEEL SIDELITE	1'2 X 6'8											•	•	•
STEEL SIDELITE	1'0 X 6'8											•	•	•
STEEL	2'0 X 8'0									•				
STEEL	2'6 X 8'0									•				
STEEL	2'8 X 8'0			•	•	•	•			•				
STEEL	3'0 X 8'0			•	•	•	•			•				

SEE PAGE 48 FOR SINGLE, DOUBLE, SIDELITE AND PATIO CONFIGURATIONS



**HALFVIEW
MINIBLIND**



**3/4 VIEW
MINIBLIND**



**FULLVIEW
MINIBLIND**



**15 LITE
FULLVIEW
MINIBLIND**



**HALFVIEW
MINIBLIND
WITH PET DOOR[°]**

[°] SEE PAGE 48

MATERIAL	SIZE	GLASS	HALFVIEW MINIBLIND	3/4 VIEW MINIBLIND	FULLVIEW MINIBLIND	15 LITE FULLVIEW MINIBLIND	HALFVIEW MINIBLIND WITH PET DOOR
STEEL	2'0 X 6'8	1-3/4"					
STEEL	2'4 X 6'8	1-3/4"					
STEEL	2'6 X 6'8	1-3/4"			•		
STEEL	2'8 X 6'8	1-3/4"	•	•	•	•	•
STEEL	2'10 X 6'8	1-3/4"	•		•	•	•
STEEL	2'10 X 6'5	1-3/4"			•	•	
STEEL	3'0 X 6'8	1-3/4"	•	•	•	•	•
STEEL	3'6 X 6'8	1-3/4"	•		•		
STEEL SIDELITE	1'2 X 6'8	1-3/4"					
STEEL SIDELITE	1'0 X 6'8	1-3/4"					
STEEL	2'0 X 8'0	1-3/4"					
STEEL	2'6 X 8'0	1-3/4"					
STEEL	2'8 X 8'0	1-3/4"	•		•		•
STEEL	3'0 X 8'0	1-3/4"	•		•		•

SEE PAGE 48 FOR SINGLE, DOUBLE, SIDELITE AND PATIO CONFIGURATIONS

METAL DOORS

EXTERNAL GRIDS



FAN LITE

6 LITE CRAFTSMAN

9 LITE
HALFVIEW

12 LITE 3/4
VIEW

10 LITE FULL-
VIEW



15 LITE
FULLVIEW



SIDELITE 3 LITE
HALFVIEW



SIDELITE 4 LITE
3/4 VIEW



SIDELITE 5 LITE
FULLVIEW

MATERIAL	SIZE	GLASS	FAN LITE	6 LITE CRAFTSMAN	9 LITE HALFVIEW	12 LITE 3/4 VIEW	10 LITE FULLVIEW	15 LITE FULLVIEW	SIDELITE 3 LITE HALFVIEW	SIDELITE 4 LITE 3/4 VIEW	SIDELITE 5 LITE FULLVIEW
STEEL	2'0 X 6'8	1-3/4"					•				
STEEL	2'4 X 6'8	1-3/4"					•				
STEEL	2'6 X 6'8	1-3/4"			•		•				
STEEL	2'8 X 6'8	1-3/4"	•	•	•		•	•			
STEEL	2'10 X 6'8	1-3/4"			•		•	•			
STEEL	2'10 X 6'5	1-3/4"					•	•			
STEEL	3'0 X 6'8	1-3/4"	•	•	•	•	•	•			
STEEL	3'6 X 6'8	1-3/4"			•	•					
STEEL SIDELITE	1'2 X 6'8	1-3/4"							•	•	•
STEEL SIDELITE	1'0 X 6'8	1-3/4"							•	•	•
STEEL	2'0 X 8'0	1-3/4"									
STEEL	2'6 X 8'0	1-3/4"									
STEEL	2'8 X 8'0	1-3/4"			◇						
STEEL	3'0 X 8'0	1-3/4"			◇						

SEE PAGE 48 FOR SINGLE, DOUBLE, SIDELITE AND PATIO CONFIGURATIONS

◇ 8'0 HALFVIEW IS A 12 LITE



5 LITE
FAN LITE



9 LITE
HALFVIEW



9 LITE (BRONZE)
HALFVIEW



12 LITE
3/4 VIEW



12 LITE
HALFVIEW



10 LITE
FULLVIEW

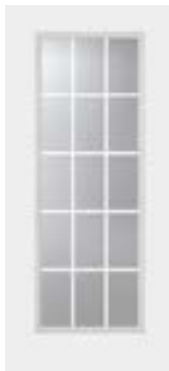

15 LITE
FULLVIEW



15 LITE (BRONZE)
FULLVIEW



SIDELITE 3 LITE
HALFVIEW



SIDELITE 5 LITE
FULLVIEW

MATERIAL	SIZE	GLASS	5 LITE FAN LITE	9 LITE HALF VIEW	9 LITE (BRONZE) HALFVIEW	12 LITE 3/4 VIEW	12 LITE HALFVIEW	10 LITE FULL VIEW	15 LITE FULL VIEW	15 LITE (BRONZE) FULLVIEW	SIDELITE 3 LITE HALFVIEW	SIDELITE 5 LITE FULLVIEW
STEEL	2'0 X 6'8	1-3/4"						•				
STEEL	2'4 X 6'8	1-3/4"						•				
STEEL	2'6 X 6'8	1-3/4"		•	•			•				
STEEL	2'8 X 6'8	1-3/4"	•	•	•			•	•	•		
STEEL	2'10 X 6'8	1-3/4"		•	•			•	•	•		
STEEL	2'10X6'5	1-3/4"						•	•	•		
STEEL	3'0 X 6'8	1-3/4"	•	•	•	•		•	•	•		
STEEL	3'6 X 6'8	1-3/4"										
STEEL SIDELITE	1'2 X 6'8	1-3/4"									•	•
STEEL SIDELITE	1'0 X 6'8	1-3/4"									•	•
STEEL	2'0 X 8'0	1-3/4"										
STEEL	2'6 X 8'0	1-3/4"										
STEEL	2'8 X 8'0	1-3/4"					•					
STEEL	3'0 X 8'0	1-3/4"					•					

SEE PAGE 48 FOR SINGLE, DOUBLE, SIDELITE AND PATIO CONFIGURATIONS

METAL DOORS

NOUVEAU



FAN LITE
*NICKEL, PATINA

HALFVIEW
*NICKEL, PATINA,
BRASS

**HALFVIEW
ROUND TOP**
*NICKEL, PATINA,
BRASS

3/4 VIEW
*NICKEL, PATINA,
BRASS

3/4 OVAL
*NICKEL, PATINA

FULL OVAL
*BRASS

*AVAILABLE FINISHES

MATERIAL	SIZE	GLASS	FAN LITE	HALFVIEW	HALFVIEW ROUND TOP	3/4 VIEW	3/4 OVAL	FULL OVAL
STEEL	2'8 X 6'8	1-3/4"	•	•	•	•	•	•
STEEL	2'10 X 6'8	1-3/4"		•				•
STEEL	3'0 X 6'8	1-3/4"	•	•	•	•	•	•
STEEL	3'6 X 6'8	1-3/4"						
STEEL SIDELITE	1'2 X 6'8	1-3/4"						
STEEL SIDELITE	1'0 X 6'8	1-3/4"						
STEEL	2'8 X 8'0	1-3/4"		•				
STEEL	3'0 X 8'0	1-3/4"		•				

SEE PAGE 48 FOR SINGLE, DOUBLE, SIDELITE AND PATIO CONFIGURATIONS



3/4 OVAL

*NICKEL, PATINA



HALFVIEW

*NICKEL, PATINA,
IRON



3/4 VIEW

*NICKEL, PATINA,
IRON



FULLVIEW

*NICKEL, PATINA,
IRON



**SIDELITE
HALFVIEW**

*IRON



**SIDELITE
3/4 VIEW**

*NICKEL, PATINA,
IRON



**SIDELITE
FULLVIEW**

*PATINA, IRON

*AVAILABLE FINISHES

MATERIAL	SIZE	GLASS	3/4 OVAL	HALFVIEW	3/4 VIEW	FULLVIEW	SIDELITE HALFVIEW	SIDELITE 3/4 VIEW	SIDELITE FULLVIEW
STEEL	2'8 X 6'8	1-3/4"	•	•	•	•			
STEEL	2'10 X 6'8	1-3/4"		•					
STEEL	3'0 X 6'8	1-3/4"	•	•	•	•			
STEEL	3'6 X 6'8	1-3/4"							
STEEL SIDELITE	1'2 X 6'8	1-3/4"					•	•	•
STEEL SIDELITE	1'0 X 6'8	1-3/4"					•	•	•
STEEL	2'8 X 8'0	1-3/4"		•					
STEEL	3'0 X 8'0	1-3/4"		•					

SEE PAGE 48 FOR SINGLE, DOUBLE, SIDELITE AND PATIO CONFIGURATIONS

METAL DOORS

MISC



**3/4 VIEW
COURTYARD**

*IRON



**3/4 VIEW
GRACE**

*NICKEL



**3/4 VIEW
JACINTO**

*IRON



**HALFVIEW
ELEMENT**

*PATINA



**9 LITE
HALFVIEW PET
DOOR^o**

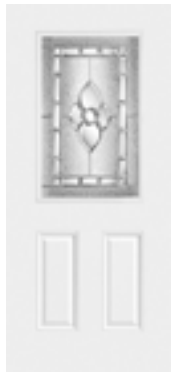

**HALFVIEW
GEORGIAN**

*IRON



**HALFVIEW
MAJESTIC**

*NICKEL



**FULLVIEW OVAL
HEIRLOOM**

*NICKEL



**FULLVIEW
HEIRLOOM**

*NICKEL

^o SEE PAGE 48
*AVAILABLE FINISHES

MATERIAL	SIZE	GLASS	3/4 VIEW COURTYARD	3/4 VIEW GRACE	3/4 VIEW JACINTO	HALFVIEW ELEMENT	HALFVIEW GEORGIAN	HALFVIEW MAJESTIC	FULLVIEW OVAL HEIRLOOM	FULLVIEW HEIRLOOM	9 LITE HALFVIEW PET DOOR
STEEL	2'8 X 6'8	1-3/4"	•	•	•	•	•	•	•	•	•
STEEL	2'10 X 6'8	1-3/4"							•	•	•
STEEL	3'0 X 6'8	1-3/4"	•	•	•	•	•	•	•	•	•
STEEL	3'6 X 6'8	1-3/4"								•	•
STEEL SIDELITE	1'2 X 6'8	1-3/4"									
STEEL SIDELITE	1'0 X 6'8	1-3/4"									
STEEL	2'8 X 8'0	1-3/4"									•
STEEL	3'0 X 8'0	1-3/4"									•

SEE PAGE 48 FOR SINGLE, DOUBLE, SIDELITE AND PATIO CONFIGURATIONS



**2 PANEL ROUND TOP
V-GROOVE (INTERIOR)**

*KNOTTY ALDER ONLY



**6 LITE LOW E
CRAFTSMAN**

*MAHOGANY, KNOTTY ALDER



**4 LITE LOW E
3/4 VIEW**

*MAHOGANY ONLY
+ BEVELED OR DOUBLE
WATER GLASS OPTION



**4 LITE LOW E
3/4 VIEW 8'**

*MAHOGANY ONLY
+ BEVELED OR DOUBLE
WATER GLASS OPTION



**6 LITE LOW E
3/4 VIEW**

*MAHOGANY ONLY
+ BEVELED OR DOUBLE
WATER GLASS OPTION



**6 LITE LOW E
3/4 VIEW 8'**

*MAHOGANY ONLY
+ BEVELED OR DOUBLE
WATER GLASS OPTION



MAHOGANY 615.8'0

*MAHOGANY, KNOTTY ALDER



MAHOGANY 623.8'0

*MAHOGANY, KNOTTY ALDER

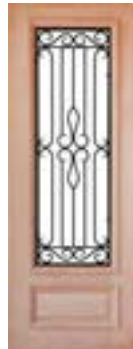

MAHOGANY 837.8'0

*MAHOGANY, KNOTTY ALDER



MAHOGANY 616.8'0

*MAHOGANY, KNOTTY ALDER

GLASS OPTION FOR THE 4 OR 6 LITE
LOW E 3/4 VIEW DOORS



*DOUBLE WATER

TYPE	SIZE	THICKNESS	2 PANEL ARCH TOP V-GROOVE	6 LITE LOW E CRAFTSMAN	4 LITE LOW E 3/4 VIEW	6 LITE LOW E 3/4 VIEW	MAHOGANY 615.8'0	MAHOGANY 623.8'0	MAHOGANY 837.8'0	MAHOGANY 616.8'0
EXT	3'0 X 6'8	1-3/4"	•	•	•	•	•	•	•	•
EXT	3'0 X 8'0	1-3/4"	•	•	•	•	•	•	•	•

WOOD DOORS

MAHOGANY/KNOTTY ALDER



MAHOGANY 615.6'8

*MAHOGANY, KNOTTY ALDER



MAHOGANY 623.6'8

*MAHOGANY, KNOTTY ALDER



MAHOGANY 837.6'8

*MAHOGANY, KNOTTY ALDER



MAHOGANY 616.6'8

*MAHOGANY, KNOTTY ALDER

GLASS OPTIONS FOR IRON GRILLE DOORS



AQUATEX



COTSWOLD



FLEMISH



REEDED



MAHOGANY 84.8'0

*MAHOGANY, KNOTTY ALDER



MAHOGANY 305S.8'0

*MAHOGANY, KNOTTY ALDER



KNOTTY ALDER 84.6'8

*MAHOGANY, KNOTTY ALDER



KNOTTY ALDER 305S.6'8

*MAHOGANY, KNOTTY ALDER

TYPE	SIZE	THICKNESS	MAHOGANY 615.6'8	MAHOGANY 623.6'8	MAHOGANY 837.6'8	MAHOGANY 616.6'8	MAHOGANY 84.8'0	MAHOGANY 305S.8'0	KNOTTY ALDER 84.6'8	KNOTTY ALDER 305S.6'8
EXT	3'0 X 6'8	1-3/4"	•	•	•	•	•	•	•	•
EXT	3'0 X 8'0	1-3/4"	•	•	•	•	•	•	•	•

SEE PAGE 48 FOR SINGLE, DOUBLE, SIDELITE AND PATIO CONFIGURATIONS



DOOR & MILLWORK

DOOR COMPONENTS

DOOR COMPONENTS

DOOR HINGE OPTIONS / VENTS



RESIDENTIAL DOOR HINGE COLOR OPTIONS

- * STEEL BASE MATERIAL
- * 5/8 RADIUS CORNERS
- * PLAIN BEARING, FIVE KNUCKLE

- * NON-RISING REMOVABLE CAP-STYLE PIN
- * AVAILABLE IN 3.5" & 4.0"



ZINC 2D



SATIN NICKEL



RUBBED BRONZE



BLACK 1D



BRUSHED CHROME



ANTIQUÉ BRASS



ANTIQUÉ NICKEL



STAINLESS STEEL



BRIGHT BRASS



POLISHED CHROME

V-SLAT VENTS

ACCOMODATES 1-3/8" AND 1-3/4" DOORS



VENT KNOTTY ALDER
12X12X1-3/8 V-SLAT
12X12X1-3/4 V-SLAT
12X16X1-3/8 V-SLAT
12X16X1-3/4 V-SLAT

VENT KNOTTY ALDER
20X24X1-3/8 V-SLAT
20X24X1-3/4 V-SLAT

ALDER FRAME
12X12X1-3/8 1LT SG
12X12X1-3/4 1LT SG

INTERIOR JAMBS

INTERIOR JAMBS	SIZE	WIDTH	THICKNESS	PRIMED FJ PINE	STAIN GRADE	KNOTTY ALDER
81" BELOW DADO	6'8	4-5/8"	11/16"	•	•	
97" BELOW DADO	8'0	4-5/8"	11/16"	•	•	
81" BELOW DADO	6'8	4-7/8"	11/16"	•		
97" BELOW DADO	8'0	4-7/8"	11/16"	•		
81" BELOW DADO	6'8	6-5/8"	11/16"	•	•	
97" BELOW DADO	8'0	6-5/8"	11/16"	•	•	
81" BELOW DADO	6'8	4-5/8"	3/4"			•
97" BELOW DADO	8'0	4-5/8"	3/4"			•
81" BELOW DADO	6'8	6-5/8"	3/4"			•
97" BELOW DADO	8'0	6-5/8"	3/4"			•

- * SOFT EDGES ON FACE OF JAMBS WITH TRIM GUIDE
- * AVAILABLE WITH KERF STOP UPON REQUEST
- * OPEN FRAMES AVAILABLE IN ALL SPECIES OF JAMBS
- * SHEET ROCK RETURN FRAMES AVAILABLE UPON REQUEST



PRIMED FJ PINE



STAIN GRADE



KNOTTY ALDER

EXTERIOR JAMBS

SIZE	WIDTH	THICKNESS	NO ROT PRIMED FJ	MAHOGANY KERF	KNOTTY ALDER KERF	COMPOSITE JAMB
6'8	4-9/16"	1-7/32"	•	•	•	•
8'0	4-9/16"	1-7/32"	•	•	•	•
6'8	6-9/16"	1-7/32"	•	•	•	•
8'0	6-9/16"	1-7/32"	•	•	•	•
6'8	5-1/8"	1-7/32"	•			
8'0	5-1/8"	1-7/32"	•			
6'8	5-3/8"	1-7/32"	•			
8'0	5-3/8"	1-7/32"	•			
6'8	9-1/16"	1-7/32"	•			
8'0	9-1/16"	1-7/32"	•			

- * EXTENDERS AVAILABLE TO MAKE JAMBS SIZE NEEDED
- * EXTERIOR JAMB COMPONENTS AVAILABLE IN ALL SPECIES
- * DOUBLE RABBIT FRAMES AVAILABLE UPON REQUEST



NO ROT PRIMED

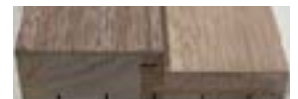

MAHOGANY STAIN GRADE



KNOTTY ALDER

DOOR COMPONENTS

SILLS



OPEN OUT SILLS

SIZE		WIDTH	TYPE	MILL FINISH	BRONZE FINISH
24"	2'0"	4-9/16"	BUMPER OO	•	•
30"	2'6"	4-9/16"	BUMPER OO	•	•
32"	2'8"	4-9/16"	BUMPER OO	•	•
34"	2'10"	4-9/16"	BUMPER OO	•	•
36"	3'0"	4-9/16"	BUMPER OO	•	•
60"	5'0"	4-9/16"	BUMPER OO	•	•
64"	5'4"	4-9/16"	BUMPER OO	•	•
74"	PATIO	4-9/16"	BUMPER OO		•
108"	9'0"	4-9/16"	BUMPER OO	•	•
148"	12.3'	4-9/16"	BUMPER OO	•	•



OPEN IN SILLS

SIZE		WIDTH	TYPE	MILL FINISH	BRONZE FINISH
24"	2'0"	4-9/16"	ADJ OI	•	•
30"	2'6"	4-9/16"	ADJ OI	•	•
32"	2'8"	4-9/16"	ADJ OI	•	•
34"	2'10"	4-9/16"	ADJ OI	•	•
36"	3'0"	4-9/16"	ADJ OI	•	•
60"	5'0"	4-9/16"	ADJ OI		•
64"	5'4"	4-9/16"	ADJ OI		•
72.5"	DOUBLE	4-9/16"	ADJ OI	•	•
74"	PATIO	4-9/16"	ADJ OI	•	•
67.5"	SIDELITE	4-9/16"	ADJ OI	•	•
148"	12.3'	4-9/16"	ADJ OI	•	•
32"	2'8"	5-5/8"	ADJ OI	•	•
36"	3'0"	5-5/8"	ADJ OI	•	•
72.5"	DOUBLE	5-5/8"	ADJ OI	•	•
74"	PATIO	5-5/8"	ADJ OI	•	•
67.5"	SIDELITE	5-5/8"	ADJ OI	•	•
148"	12.3'	5-5/8"	ADJ OI	•	•



ADA SILLS

SIZE		WIDTH	TYPE	MILL FINISH	BRONZE FINISH
24"	2'0"	4-9/16"	ADJ OI	•	•
30"	2'6"	4-9/16"	ADJ OI	•	•
32"	2'8"	4-9/16"	ADJ OI	•	•
34"	2'10"	4-9/16"	ADJ OI	•	•
36"	3'0"	4-9/16"	ADJ OI	•	•

REPLACEABLE DECK SILLS

SIZE	WIDTH	TYPE	MILL FINISH	BRONZE FINISH
2'8"	4-9/16"	OI	•	•
3'0"	4-9/16"	OI	•	•
6'0"	4-9/16"	OI	•	•
2'8"	6-9/16"	OI	•	•
3'0"	6-9/16"	OI	•	•
6'0"	6-9/16"	OI	•	•



REPLACEABLE DECK SILLS

REPLACEABLE DECK

SIZE	WIDTH	TYPE	MILL FINISH	BRONZE FINISH
2'8"	4-9/16"		•	•
6'0"	4-9/16"		•	•
3'0"	6-9/16"		•	•
6'0"	6-9/16"		•	•



WEATHERSTRIP

WEATHERSTRIP

SIZE	WEATHERSTRIP	BEIGE	BRONZE
81"	JF65	•	•
97"	JF65	•	•
97"	LONG REACH	•	•



SWEEPS

* SILL EXTENDERS AVAILABLE IN:
3/4", 2" & 2" FOR OO & OI ONLY

SWEEPS

SIZE	SWEEPS	BEIGE	BRONZE
31-3/4"	FBG/MTL	•	
35-3/4"	FBG/MTL	•	
41-3/4"	FBG/MTL	•	
35-3/4"	WOOD	•	•
42"	WOOD		•
48"	WOOD	•	•

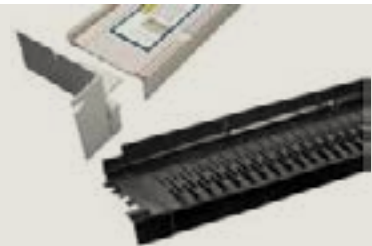

SILL PANS

AVAILABLE UP TO:
4-9/16" UP TO 78"
6-9/16" UP TO 78"

DOOR COMPONENTS

PANOLOCK MULTI-POINT LOCK



PANOLOCK+
MULTI-POINT LOCK

PanoLock®+ is the first and only multi-point lock that works with a wide variety of off-the-shelf hardware, including electronic deadbolts! That's affordable security and performance for every entry door.





DOOR COMPONENTS

PANOLOCK MULTI-POINT LOCK

Works with a wide variety of standard hardware, including electronic deadbolts.*

Use of multi-point locks has been limited due to high cost, difficult installation and operation, and the limitations of dedicated handleset hardware required for each lock offering. Not so with PanoLock®+.

An innovative system of adapters lets PanoLock+ work with a wide variety of off-the-shelf hardware. Both standard and smart locks. Brands like Schlage, Kwikset and more.

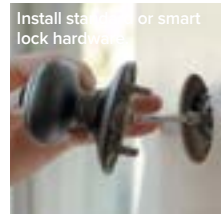

PanoLock+ Square Adapter.



PanoLock+ can work with a thumb press, lever or knob.

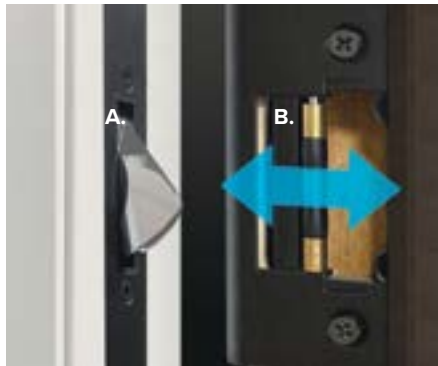

A. Tapered bolt. Unlike other locks that tend to catch, PanoLock+'s tapered bolts engage easily, even when the door is out of alignment.

B. Adjustable roller strike. Rollers lower operating force allowing the tapered bolt to gently snug the door panel against the weatherstrip.

Faceplate Finishes



Bronze Anodized Satin Nickel



White Anodized

Sizes
6/8
8/0

Adjustable Strike Plate Finishes



Victorian Bronze Satin Nickel Bright Brass



Black Stainless Steel

Security. Performance. Standard.

Easy to live with.

A simple turn of the deadbolt operates both tapered bolts smoothly and the handle-set operates the handle-set latch. Three points of secure contact. PanoLock+ is easy to live with, even after years of use.

Easy to work with.

PanoLock+ is flexible. Hanging and swing can be set in the shop, reducing SKUs.

- No dedicated hardware required.
- No need for dedicated panels.
- No difficult installation.
- No expensive templates.

Tested and proven.

PanoLock+ has been extensively tested and proven to perform, even in severe conditions. PanoLock+ withstood winds up to 200 mph in structural testing.

- Operating torque/force tested as low as 2 in/lbs with select handle sets.
- Durability Cycle Testing Passed 100,000 cycles.
- Air infiltration and exfiltration Tested to A2.
- Water Infiltration and Exfiltration Tested DP60 with Z-Articulating Cap sill.
- Impact/Forced Entry Resistance Tested Grade 40.



*Please refer to Endura's website to verify that your lockset choice has been tested for compatibility with PanoLock+.

<https://www.enduraproducts.com/pano-lock-plus/>



Innovation powered by Endura.
Innovation protected under patents and patents pending in U.S. and Canada.
See www.endurapatents.com.
Form # RDS SS-23 Effective 3/10/23 © Endura Products

LIGHTEN

IN-FRAME LIGHT



NEW!

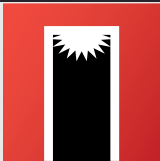

LIGHTEN™ IN-FRAME LIGHT

Built with security in mind, a battery powered light bar built into the jamb header illuminates entry doors when movement is detected using dusk-to-dawn motion sensors. Add functionality and peace of mind to any exterior door with LightEn™.





LIGHTEEN

IN-FRAME LIGHT

Introducing LightEn™, an innovative lighted header addition to Endura's outstanding line of door frames for pre-hung exterior doors. LightEn equips entry doors with a built-in overhead light to provide illumination at night for security and convenience.



Features and Benefits

Requires No Wiring:

The LightEn header is battery-powered and removes the need for in-home wiring.

Automatic Light:

Dusk to dawn automatic motion sensors ensure illumination at night and in dark areas.

Battery Pack:

LightEn is powered with Lithium AA batteries. The battery pack uses eight standard Lithium AA batteries for easy off-the-shelf replacement.

Availability and Pricing

- Compatible with Endura FusionFrame, FrameSaver and commodity jams.
- Length Options:
 - Single Doors (2/6 to 3/0)
 - Double Doors (up to 6/0)
 - Mull Headers (1/2-3/0-1/2)



INNOVATION POWERED BY ENDURA.

Endura is built on innovation and a commitment to performance. Our products are problem solvers, born directly from insight we've learned from our customers about real-world challenges. We're always pushing ourselves to face an ever-present challenge: How can we make your door system work better?

Innovation protected under patents and patents pending in U.S. and Canada.
See www.endurapatents.com.
Form #LightEn Pre Effective 10/2/24 © Endura Products



DOOR COMPONENTS

WOOD DOOR ACCESSORIES / PET DOOR



WOOD DOOR ACCESSORIES



FLORENTINE GRILLE
BLACK



MADRID GRILLE
BLACK



PARIS KW GRILLE BLACK



28" FLORENTINE STRAP



28" MADRID STRAP



SPEAKEASY DOOR



1.5" ROUND
CLAVO



1.5" SQUARE
CLAVO



PET DOOR COMPONENT

AVAILABLE IN 4 SIZES
SMALL PET DOOR WHT
MEDIUM PET DOOR WHT
EXTRA-LRG PET DOOR WHT
SUPER-LRG PET DOOR WHT

PET DOORS CAN BE INSTALLED ONTO ANY FLUSH BOTTOM DOOR.



DOOR & MILLWORK

DOOR INFORMATION

SIZES & ROUGH OPENINGS

INTERIOR DOOR UNITS



INTERIOR DOOR UNIT SIZES & ROUGH OPENINGS

Pocket Frame

Inswing

		Minimum			Minimum		
		Call Size	Actual Size	Rough Opening	Call Size	Actual Size	Rough Opening
Single							
				Single			
		2/0 6/8	25-3/4 x 81-11/16	26-3/4 x 82-1/2	2/0 6/8	49-1/2 x 83-3/8	50-1/2 x 83-7/8
		2/4 6/8	29-3/4 x 81-11/16	30-3/4 x 82-1/2	2/4 6/8	57-1/2 x 83-3/8	58-1/2 x 83-7/8
		2/6 6/8	31-3/4 x 81-11/16	32-3/4 x 82-1/2	2/6 6/8	61-1/2 x 83-3/8	62-1/2 x 83-7/8
		2/8 6/8	33-3/4 x 81-11/16	34-3/4 x 82-1/2	2/8 6/8	65-1/2 x 83-3/8	66-1/2 x 83-7/8
		3/0 6/8	37-3/4 x 81-11/16	38-3/4 x 82-1/2	3/0 6/8	73-1/2 x 83-3/8	74-1/2 x 83-7/8
Ball Catch	Double						
				Double			
		4/0 6/8	49-7/8 x 81-11/16	50-7/8 x 82-1/2	4/0 6/8	97-1/2 x 83-3/8	98-1/2 x 83-1/2
		5/0 6/8	61-7/8 x 81-11/16	62-7/8 x 82-1/2	4/8 6/8	113-1/2 x 83-3/8	114-1/2 x 83-1/2
		5/4 6/8	65-7/8 x 81-11/16	66-7/8 x 82-1/2	5/0 6/8	121-1/2 x 83-3/8	122-1/2 x 83-1/2
		6/0 6/8	73-7/8 x 81-11/16	74-7/8 x 82-1/2	5/4 6/8	129-1/2 x 83-3/8	130-1/2 x 83-1/2
T-Astragal	Double				6/0 6/8	145-1/2 x 83-3/8	146-1/2 x 83-1/2
		4/0 6/8	50-1/2 x 81-11/16	51-1/2 x 82-1/2			
		5/0 6/8	62-1/2 x 81-11/16	63-1/2 x 82-1/2			
		5/4 6/8	66-1/2 x 81-11/16	67-1/2 x 82-1/2			
		6/0 6/8	74-1/2 x 81-11/16	75-1/2 x 82-1/2			

For 8/0 tall units, add 16" to Heights

EXTERIOR DOOR UNIT SIZES & ROUGH OPENINGS

Inswinging				Outswinging			
Minimum				Minimum			
Call Size	Actual Size	Rough Opening	Call Size	Actual Size	Rough Opening	Call Size	Actual Size
Single							
2/0 6/8	25- 1/2 x 81-3/4	26-1/2 x 82-1/2	2/0 6/8	25- 1/2 x 80-3/8	26-1/2 x 81-1/8	2/0 6/8	25- 1/2 x 80-3/8
2/4 6/8	29-1/2 x 81-3/4	30-1/2 x 82-1/2	2/4 6/8	29- 1/2 x 80-3/8	30- 1/2 x 81-1/8	2/4 6/8	29- 1/2 x 80-3/8
2/6 6/8	31-1/2 x 81-3/4	32-1/2 x 82-1/2	2/6 6/8	31- 1/2 x 80-3/8	32-1/2 x 81-1/8	2/6 6/8	31- 1/2 x 80-3/8
2/8 6/8	33-1/2 x 81-3/4	34-1/2 x 82-1/2	2/8 6/8	33-1/2 x 80-3/8	34-1/2 x 81-1/8	2/8 6/8	33-1/2 x 80-3/8
3/0 6/8	37-1/2 x 81-3/4	38-1/2 x 82-1/2	3/0 6/8	37- 1/2 x 80-3/8	38- 1/2 x 81-1/8	3/0 6/8	37- 1/2 x 80-3/8
Double							
4/0 6/8	50 x 81-3/4	51 x 82-1/2	4/0 6/8	49-7/8 x 80-3/8	50-7/8 x 81-1/8	4/0 6/8	49-7/8 x 80-3/8
5/0 6/8	62 x 81-3/4	63 x 82-1/2	5/0 6/8	61-7/8 x 80-3/8	62-7/8 x 81-1/8	5/0 6/8	61-7/8 x 80-3/8
5/4 6/8	66 x 81-3/4	67 x 82-1/2	5/4 6/8	65-7/8 x 80-3/8	66-7/8 x 81-1/8	5/4 6/8	65-7/8 x 80-3/8
6/0 6/8	74 x 81-3/4	75 x 82-1/2	6/0 6/8	73-7/8 x 80-3/8	74-7/8 x 81-1/8	6/0 6/8	73-7/8 x 80-3/8
Patio							
4/0 6/8	50-1/4 x 81-3/4	51-1/4 x 82-1/2	4/0 6/8	50-1/4 x 80-3/8	51-1/4 x 81-1/8	4/0 6/8	50-1/4 x 80-3/8
5/0 6/8	62-1/4 x 81-3/4	63-1/4 x 82-1/2	5/0 6/8	62-1/4 x 80-3/8	63-1/4 x 81-1/8	5/0 6/8	62-1/4 x 80-3/8
5/4 6/8	66-1/4 x 81-3/4	67-1/4 x 82-1/2	5/4 6/8	66-1/4 x 80-3/8	67-1/4 x 81-1/8	5/4 6/8	66-1/4 x 80-3/8
6/0 6/8	74-1/4 x 81-3/4	75-1/4 x 82-1/2	6/0 6/8	74-1/4 x 80-3/8	75-1/4 x 81-1/8	6/0 6/8	74-1/4 x 80-3/8
TDI Patio							
4/0 6/8	50-3/4 x 81-3/4	51-3/4 x 82-1/2	4/0 6/8	50-3/4 x 80-3/8	51-3/4 x 81-1/8	4/0 6/8	50-3/4 x 80-3/8
5/0 6/8	62-3/4 x 81-3/4	63-3/4 x 82-1/2	5/0 6/8	62-3/4 x 80-3/8	63-3/4 x 81-1/8	5/0 6/8	62-3/4 x 80-3/8
5/4 6/8	66-3/4 x 81-3/4	67-3/4 x 82-1/2	5/4 6/8	66-3/4 x 80-3/8	67-3/4 x 81-1/8	5/4 6/8	66-3/4 x 80-3/8
6/0 6/8	74-3/4 x 81-3/4	75-3/4 x 82-1/2	6/0 6/8	74-3/4 x 80-3/8	75-3/4 x 81-1/8	6/0 6/8	74-3/4 x 80-3/8
Retro							
5/0 6/8	59-1/2 x 79-3/4	60x80	5/0 6/8	59-1/2 x 78-3/8	60 x 80	5/0 6/8	59-1/2 x 78-3/8
6/0 6/8	71-1/2 x 79-3/4	72 x 80	6/0 6/8	71-1/2 x 78-3/8	72 x 80	6/0 6/8	71-1/2 x 78-3/8

For 8/0 tall units, add 16" to Heights

DOOR HANDING GUIDE

















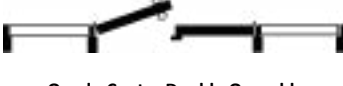
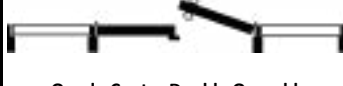













IN SWING



IN SWING

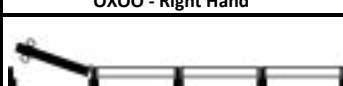

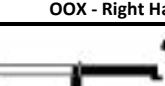

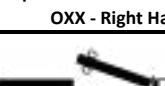











X = Operating door O = Fixed door







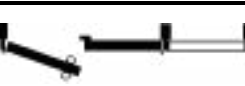

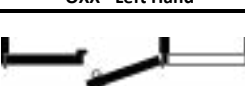

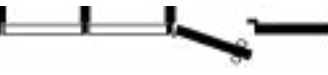
Point of Reference = Standing on the Exterior side of Unit

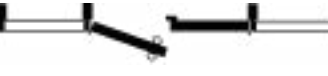
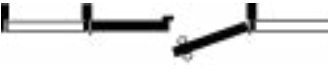
 Single X - Left Hand	Interior  Exterior Single X - Right Hand	 Quad - Double Operable O0XX - Left Hand	 Quad - Double Operable O0XX - Right Hand
 Double XX - Left Hand	 Double XX - Right Hand	 Quad - Center Double Operable OXXO - Left Hand	 Quad - Center Double Operable OXXO - Right Hand
 Patio - Center Hinge OX - Left Hand	 Patio - Center Hinge XO - Right Hand	 Quad - Double Operable XXOO - Left Hand	 Quad - Double Operable XXOO - Right Hand
 Patio - Jamb Hinge XO - Left Hand	 Patio - Jamb Hinge OX - Right Hand	 Quad - Single Operable OOOX - Left Hand	 Quad - Single Operable OOOX - Right Hand
 Triple Unit - Center Operable OXO - Left Hand	 Triple Unit - Center Operable OXO - Right Hand	 Quad - Single Operable OOXO - Left Hand	 Quad - Single Operable OOXO - Right Hand
 Triple Unit - Single Operable OOX - Left Hand	 Triple Unit - Single Operable XOO - Right Hand	 Quad - Single Operable OXOO - Left Hand	 Quad - Single Operable OXOO - Right Hand
 Triple Unit - Single Operable XOO - Left Hand	 Triple Unit - Single Operable OOX - Right Hand	 Quad - Single Operable XOOO - Left Hand	 Quad - Single Operable XOOO - Right Hand
 Triple Unit - Double Operable XXO - Left Hand	 Triple Unit - Double Operable OXX - Right Hand		
 Triple Unit - Double Operable OXX - Left Hand	 Triple Unit - Double Operable XXO - Right Hand		

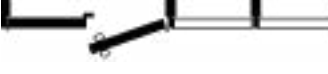
OUTSWING

X = Operating door O = Fixed door
Point of Reference = Standing on the Exterior side of Unit

 Single X - Right Hand	Interior Exterior  Single X - Left Hand
 Double XX - Right Hand	 Double XX - Left Hand
 Patio - Center Hinge OX - Right Hand	 Patio - Center Hinge XO - Left Hand
 Patio - Jamb Hinge XO - Right Hand	 Patio - Jamb Hinge OX - Left Hand
 Triple Unit - Center Operable OXO - Right Hand	 Triple Unit - Center Operable OXO - Left Hand
 Triple Unit - Single Operable OOX - Right Hand	 Triple Unit - Single Operable XO - Left Hand
 Triple Unit - Single Operable XOO - Right Hand	 Triple Unit - Single Operable OOX - Left Hand
 Triple Unit - Double Operable XXO - Right Hand	 Triple Unit - Double Operable OXX - Left Hand
 Triple Unit - Double Operable OXX - Right Hand	 Triple Unit - Double Operable XXO - Left Hand

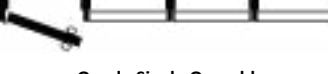
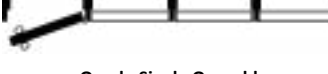
 Quad - Double Operable OOX - Right Hand	 Quad - Double Operable OOX - Left Hand
 Quad - Center Double Operable OXXO - Right Hand	 Quad - Center Double Operable OXXO - Left Hand
 Quad - Double Operable XXOO - Right Hand	 Quad - Double Operable XXOO - Left Hand
 Quad - Single Operable OOOX - Right Hand	 Quad - Single Operable OOOX - Left Hand
 Quad - Single Operable OOXO - Right Hand	 Quad - Single Operable OOXO - Left Hand
 Quad - Single Operable OXOO - Right Hand	 Quad - Single Operable OXOO - Left Hand
 Quad - Single Operable XOOO - Right Hand	 Quad - Single Operable XOOO - Left Hand

MOLDED DOOR CUTDOWN RANGES



CARRARA®

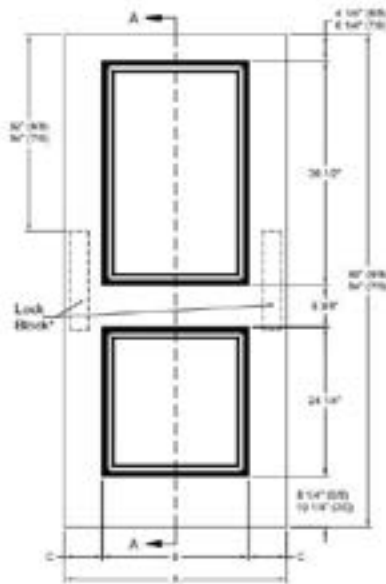

RANGE	
SLAB (1 PANEL)	
54-1/2"	63-1/2"
UNIT	
56-5/8"	65-5/8"
SLAB (2 PANEL)	
85-1/2"	95-1/2"
UNIT	
87-5/8"	97-5/8"

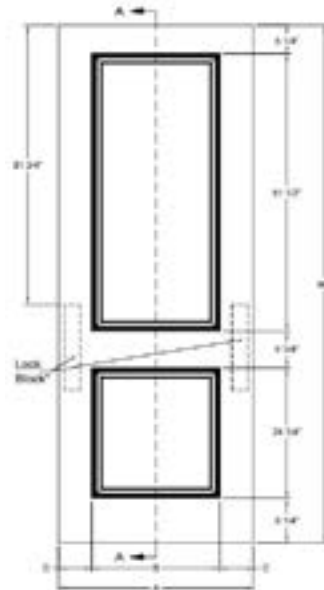

RANGE	
SLAB (1 PANEL)	
39-1/2"	47-1/4"
UNIT	
41-5/8"	49-3/4"
SLAB (1 PANEL)	
27-1/4"	38-3/4"
UNIT	
29-3/4"	40-7/8"
SLAB (2 PANEL)	
54-1/2"	79-1/2"
UNIT	
56-5/8"	81-5/8"

ROCKPORT™

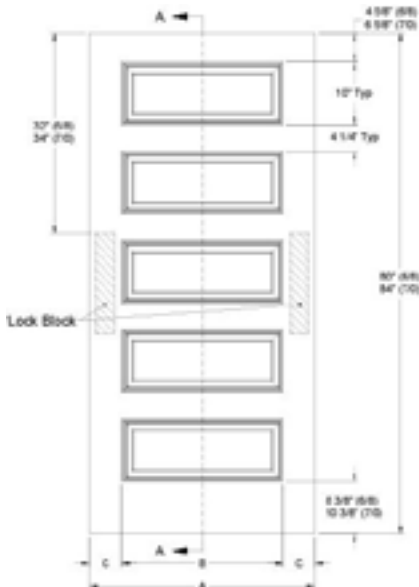

RANGE	
SLAB (6 PANEL)	
84-1/4"	95-1/2"
UNIT	
86-3/8"	97-5/8"

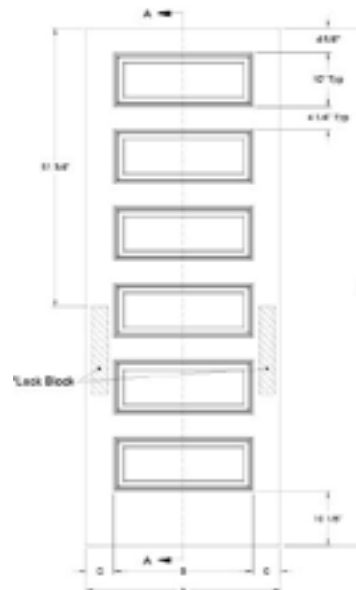

RANGE	
SLAB (2 PANEL)	
28-7/8"	33-7/8"
SLAB (3 PANEL)	
41-1/2"	48-1/8"
SLAB (4 PANEL)	
55-3/4"	62-3/8"
SLAB (5 PANEL)	
70"	79-1/2"

SANTA FE™

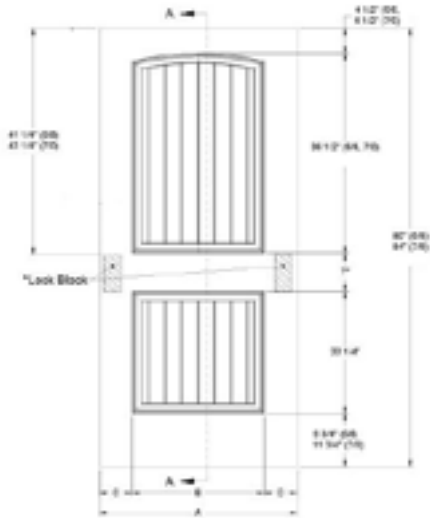

RANGE	
SLAB (1 PANEL)	
55-1/2"	63-7/8"
UNIT	
57-5/8"	66"
SLAB (2 PANEL)	
84-3/4"	95-1/2"
UNIT	
86-7/8"	97-5/8"

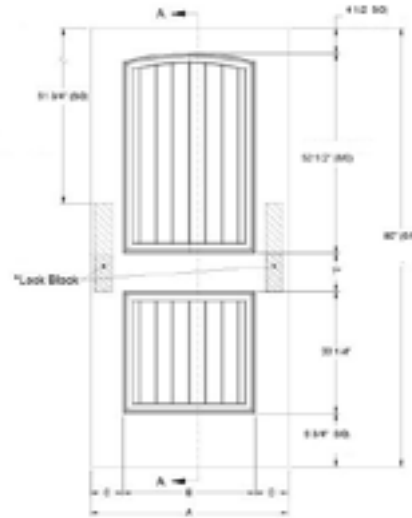

RANGE	
SLAB (1 PANEL)	
39-1/2"	47-7/8"
UNIT	
41-5/8"	50"
SLAB (1 PANEL)	
25-1/4"	38-5/8"
UNIT	
27-3/8"	40-6/8"
SLAB (2 PANEL)	
54-1/2"	40-6/8"
UNIT	
56-5/8"	81-5/8"

CAIMAN®

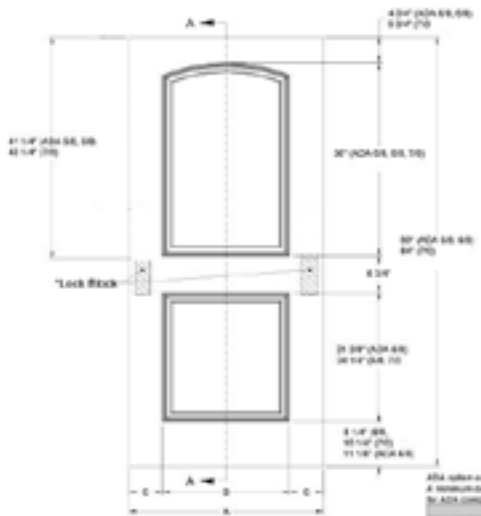

RANGE	
SLAB (1 PANEL)	
53"	63-1/2"
UNIT	
55-1/8"	65-5/8"
SLAB (1 PANEL)	
87-3/4"	95-1/2"
UNIT	
89-7/8"	97-5/8"

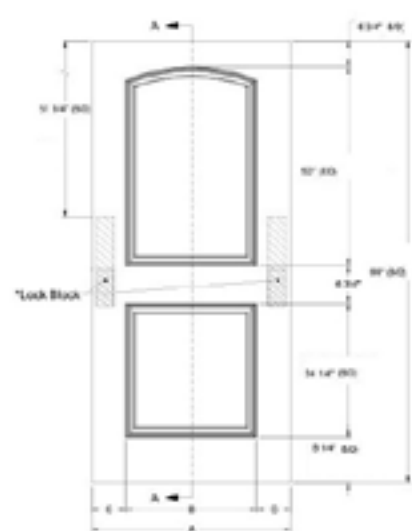

RANGE	
SLAB (1 PANEL)	
39-1/2"	47-1/2"
UNIT	
41-5/8"	49-3/4"
SLAB (1 PANEL)	
27-1/4"	38-3/4"
UNIT	
29-3/8"	40-7/8"
SLAB (2 PANEL)	
70"	79-1/2"
UNIT	
72-1/8"	81-5/8"

MOLDED DOOR CUTDOWN RANGES



COLONIST®

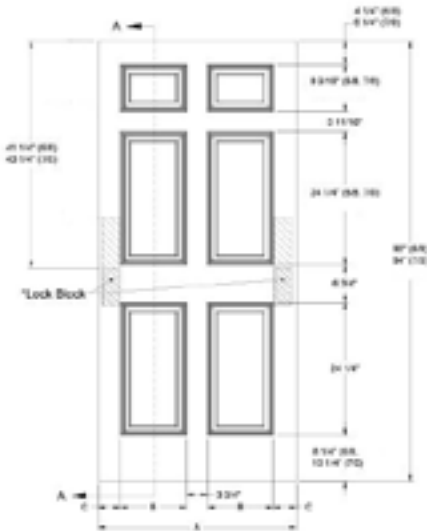

RANGE	
SLAB (4 PANEL SHORT)	
54-1/2"	63-1/2"
SLAB (4 PANEL TALL)	
71-2/8"	79-6/8"
SLAB (6 PANEL)	
88-1/2"	95-1/2"

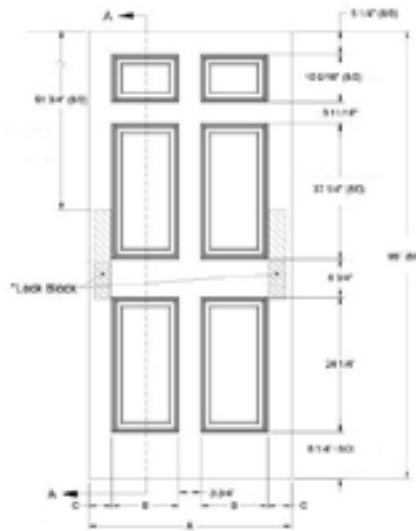

RANGE	
SLAB (1 PANEL)	
27-1/4"	38-3/4"
SLAB (4 PANEL SHORT)	
31"	39"
SLAB (4 PANEL TALL)	
58-1/4"	66-3/4"
SLAB (6 PANEL)	
74-3/4"	79-1/2"

MADISON®

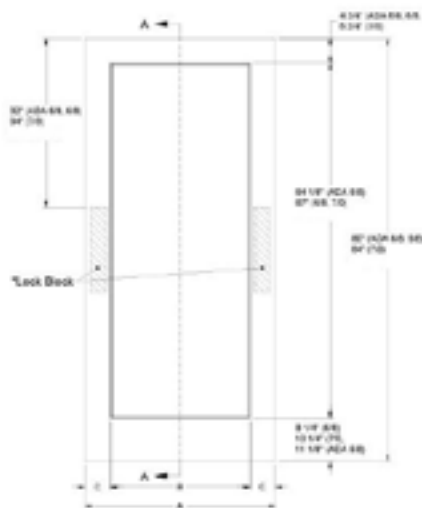

RANGE	
SLAB	
84"	95-1/2"
UNIT	
86-1/8"	97-5/8"

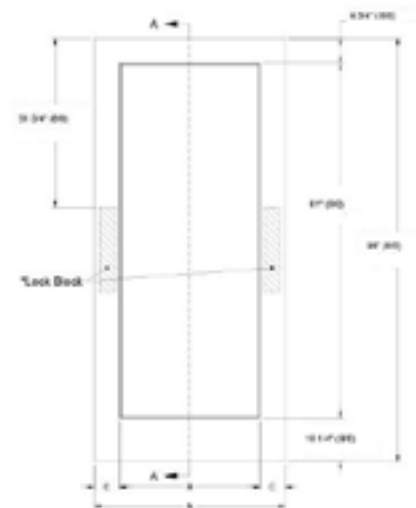

RANGE	
SLAB	
70"	79-1/2"
UNIT	
72-1/8"	81-5/8"

MONROE®

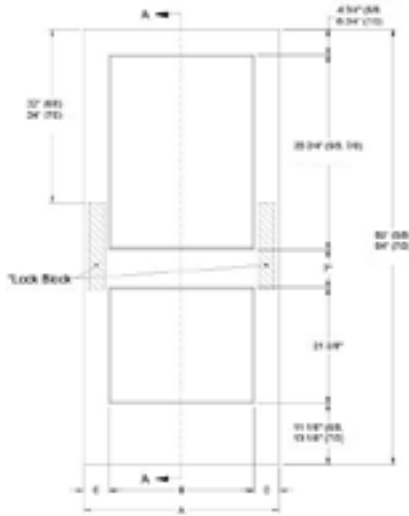

RANGE	
SLAB (1 PANEL)	
54-3/4"	63-1/2"
UNIT	
56-7/8"	65-5/8"
SLAB (2 PANEL)	
83-1/8"	95-1/2"
UNIT	
85-2/8"	97-5/8"

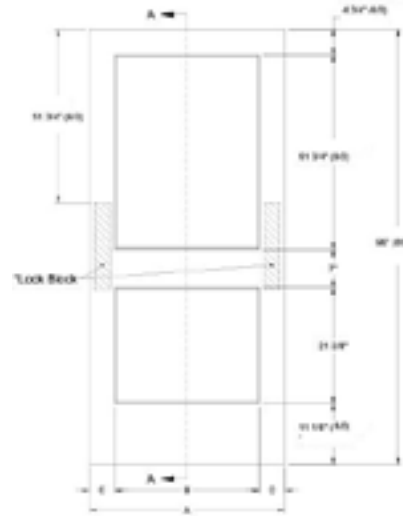

RANGE	
SLAB (1 PANEL TALL)	
38-3/4"	47-1/2"
SLAB (1 PANEL SHORT)	
24-3/8"	39"
SLAB (2 PANEL)	
67-1/8"	79-1/2"

BIRKDALE™

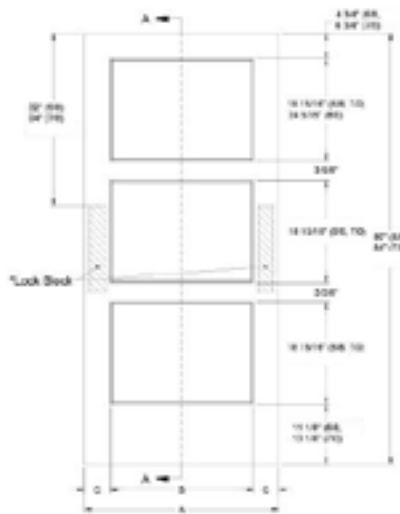

RANGE	
SLAB (1 PANEL)	
27-1/3"	38-4/9"
SLAB (2 PANEL)	
55-1/4"	65-3/8"
SLAB (3 PANEL)	
83-1/4"	95-1/2"

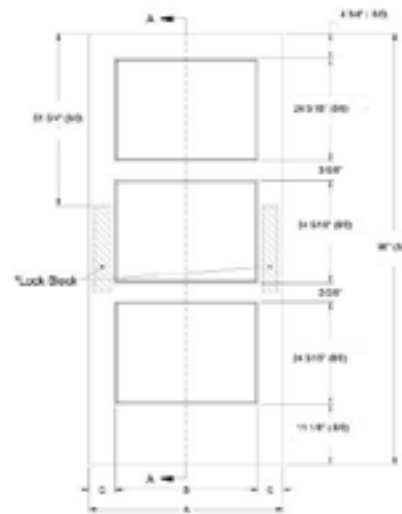

RANGE	
SLAB (1 PANEL)	
24"	33-1/4"
SLAB (2 PANEL)	
44-1/2"	55-4/5"
SLAB (3 PANEL)	
67"	79-1/2"

MOLDED DOOR CUTDOWN RANGES



CONMORE®

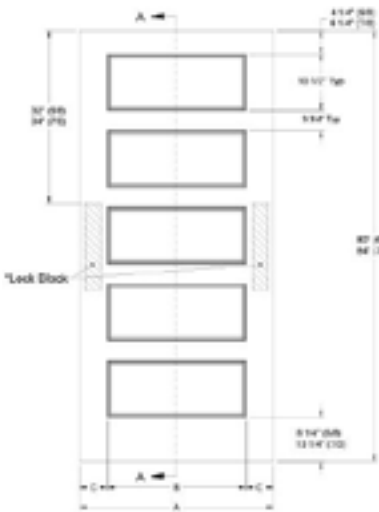

RANGE	
SLAB (1 PANEL)	
84-3/4"	95-1/2"
UNIT	
86-7/8"	97-5/8"

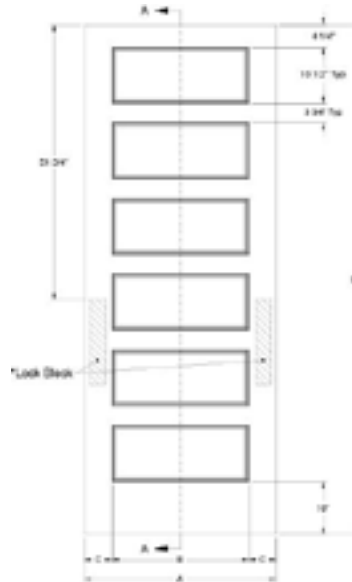

RANGE	
SLAB (1 PANEL)	
27-3/4"	36-3/8"
UNIT	
41-7/8"	50-4/7"
SLAB (1 PANEL)	
56"	64-3/4"
UNIT	
70-1/4"	79-1/2"

CAMDEN®

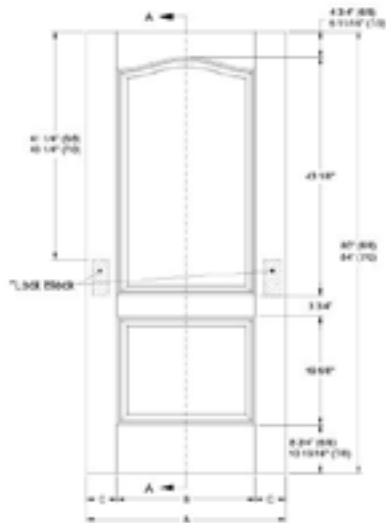

RANGE	
SLAB (TOP PANEL)	
46-1/8"	52-1/4"
SLAB (BOTTOM PANEL)	
22-5/8"	31"
SLAB	
69-1/2"	79-1/2"

CRAFTSMAN III™

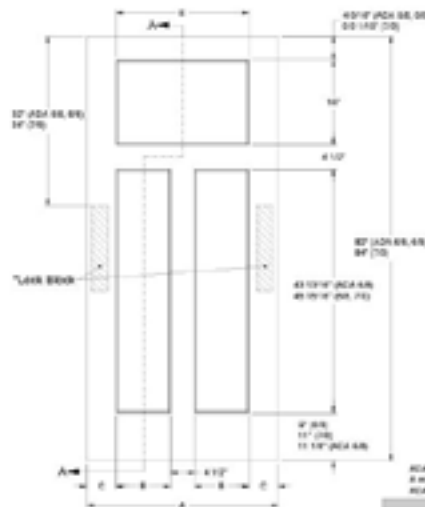

RANGE	
SLAB (TOP PANEL)	
19"	25-1/4"
SLAB (BOTTOM PANEL)	
49"	58-7/8"
SLAB	
69-4/9"	79-1/2"



DOOR & MILLWORK

**PREMIUM
INTERIOR
DOORS**

SPECIAL ORDER ONLY



VARPRIMA[®]

INTERIOR DOORS



DISTINCTIVE DESIGN COLLECTION

This ever-evolving collection reflects emerging interior design trends, offering doors that make bold architectural statements for today's homes. With trending wood species and glass options, design details such as narrow stiles and rails and v-groove panels, and custom moldings and jambs, this collection lets you create the extraordinary spaces you envision.

| [JELD-WEN.COM/KARONA](https://www.jeld-wen.com/karona)



A



B



C

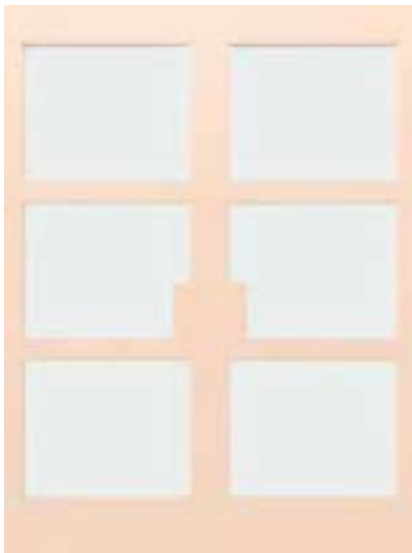

D



E



F



G

- A. AA410** Maple 2-panel Double Arch Top with Custom Molding, shown in Jet Black Stain **B. RR6000** Rift White Oak 1-Panel Flat V-groove Radius 1
C. K8000 Rift White Oak Stacked Rails, shown in Clear Finish **D. K5300** Maple 3-lite Double Door with Reeded Glass and Custom Lock Block
E. K6040 Rift White Oak 4-Lite with Clear Glass, shown in Clear Finish **F. K6000** Knotty Alder 1-Panel with V-groove
G. K4010 Knotty Alder 2-panel with V-groove

See additional door designs at jeld-wen.com/karona. Stain and paint colors shown are examples only; most doors are available with the stain finish of your choice.



CRAFTSMAN COLLECTION

These flat panel doors feature smooth surfaces, clean lines, and square sticking detail that keeps designs streamlined. Multiple designs hearken back to the stylish simplicity of classic American Craftsman and Shaker creations. Karona™ flat panel doors include trend-right choices for modern, coastal, and farmhouse style homes and venues.

| [JELD-WEN.COM/KARONA](https://www.jeld-wen.com/karona)

JELD-WEN® (SPECIAL ORDER)
KARONA® CRAFTSMAN COLLECTION



A



B



C

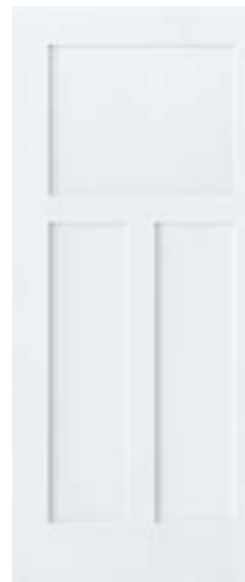

D



E



F

A. K6000 Rift Cut White Oak 1-Panel Shaker **B. K6000** MDF 1-Panel Shaker **C. K4010** MDF 2-Panel Shaker
D. K5320 MDF 3-Panel Craftsman **E. K5300** White Birch 3-Panel Shaker **F. K53050** Poplar 5-Panel Shaker



CLASSIC COLLECTION

A hallmark of fine homes for hundreds of years, raised panel interior doors are beautifully realized today in our Karona™ line. Choose from dozens of designs and wood species that enhance traditional or historical spaces with ageless elegance, architectural interest, and lasting performance. Sticking profiles can be chosen to match your millwork style preference.

JELD-WEN.COM/KARONA

JELD-WEN® (SPECIAL ORDER)
KARONA® CLASSIC COLLECTION



A



B



C



D



E



F



G



H



I



J

A. K6000 Maple 1-Panel Raised **B. K4010** Poplar 2-Panel Raised **C. K5300** Knotty Alder 3-Panel Raised **D. K5300** MDF 3-Panel Raised, in Custom Paint **E. K5310** Walnut 3-Panel Raised **F. K1081** Alder 3-Panel Raised **G. K5400** Knotty Alder 4-Panel Raised **H. K5410** Quarter Sawn African Mahogany 4-Panel Raised **I. K3040** Poplar 4-Panel Raised **J. K3060** Walnut 6-Panel Raised **K. K5610** Alder 6-Panel Raised **L. K5660** Alder 6-Panel Raised **M. K3080** Alder 8-Panel Raised **N. K5810** Walnut 8-Panel Raised **O. K3180** 18-Panel Raised Walnut

See additional door designs at jeld-wen.com/karona. Stain and paint colors shown are examples only; most doors are available with the stain finish of your choice.



A



B



C

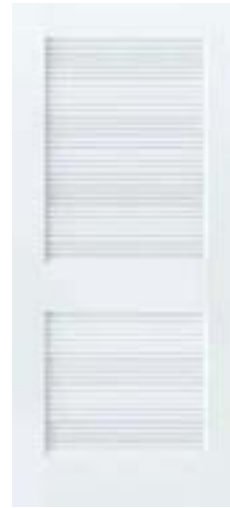

D



E



F



G



H



I



J

A. K7330 Walnut Full Louver **B. K7300** White Birch Louver/Louver **C. K7320** MDF Louver/Panel
D. K7300 MDF Plantation Louver/Louver **E. K7302** MDF Plantation Louver/Louver Bifold **F. K6000** MDF 1-Panel Modern Vent
G. K4010 MDF 2-Panel Modern Vent **H. K4010** MDF Panel/Modern Vent **I. K4010** MDF Modern Vent/Panel **J. K4010** MDF 3-Panel Modern Vent

See additional door designs at jeld-wen.com/karona. Stain and paint colors shown are examples only; most doors are available with the stain finish of your choice.



Architectural Concepts / Door Collection

Clearly Different

AC/DC MDF Doors

MDF (Medium Density Fiberboard) is a durable, stable, and eco-friendly choice for interior doors. Its smooth, homogeneous construction resists warping, cracking, and splitting while outperforming natural wood for painted finishes. Made from recycled wood fiber, our premium MDF contains no low-density fillers and is NAF (No Added Formaldehyde), MR30 moisture resistant, and Carb II and TSCA Title VI compliant—all at no extra cost.



CHIPS



SHAVINGS



SAWDUST



MDF FIBER WITH RESIN

MDF (Medium Density Fiber) is a 100% recycled product that was green before “green” was cool, making it an excellent choice for doors. It’s made by breaking down wood residuals—chips, shavings, and sawdust—into individual fibers, removing the wood’s natural “memory,” then reforming them into a stable, uniform board. The fibers are dried, blended with resin, and compressed under heat and pressure to create a consistent, durable panel.



Superior Structural Wood Edge

MDF holds screws well through the face, but not as well through the edge. We have worked diligently on designing a wood edge that provides a complete glue bond, without any gaps, increasing the structural rigidity of the door. Our wood edge will accept all of your hardware with ease.

- **742 lbs Screw Pull Test**
- **WDMA Extra Heavy Duty**

Door Styles



PANEL

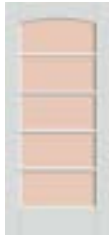

GLASS

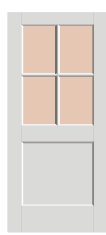

PANEL LITE

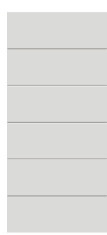

FLUSH



V-GROOVE



TAMBOR



LOUVER



MODERN

Fire-Rated Doors

You can focus on a proper fire protection system and your design vision when selecting one of our fire-rated doors. Each door, available in fire ratings of 20-, 45-, 60- and 90-minutes, is carefully designed to match any of our non-rated doors, providing you architectural consistency and peace of mind.

	20-minute MDF	20-minute Wood	45- and 60-minute MDF	90-minute MDF
Category	Category A Category B Neutral Pressure	Category A Category B Neutral Pressure	Category A	Category A
Thickness	1-3/4" minimum	1-3/4" minimum	1-3/4" minimum	1-3/4" minimum
Maximum Width Single	4'0"	4'0"	4'0"	4'0"
Maximum Width Pair	8'0"	8'0"	7'0"	6'0"
Maximum Height	8'0"	8'0"	8'0"	8'0"
Fire Glass Max. Area	2,656 sq. inches	2,656 sq. inches	1,248 sq. inches (45 min.) 100 sq. in. - Matching sticking (60 min.) 1,296 sq. in. with vision kit	100 sq. in. - matching sticking 1,080 sq. in. with vision kit
Standards	ASTM E-152, NFPA 80, NFPA 252 (2017), UL10B, UL10C, CAN/ULC S104 (2015)			



Panel Doors

The distinctive look of every panel door we manufacture is in the profile. The door profile is defined by the joints where the sticking and panels come together and the styles of each. Fortunately, we offer over 45 combinations of sticking and panel styles, so you can achieve the perfect profile look for your project. If not, we will be happy to help you through the process to create a custom solution.

Each of our panel doors are built with authentic stile-and-rail construction for architecturally correct results. You can choose from diverse panel door styles in configurations from one to nine panels.



www.archconceptsllc.com/panel-doors/

Glass Doors

Constructed with old-world craftsmanship, our glass doors enhance almost any space. Whether you're designing for an elegant entrance or a more intimate space, our experts can help you select the door type and glass panels that provide just the right balance of natural light, privacy and style.

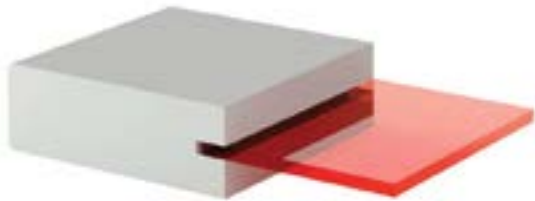

www.archconceptsllc.com/glass-doors/



www.archconceptsllc.com/panel-lite/





V-Groove Series Profile

For the classic look of a plank door, we recommend our V-Groove Series doors. Although built with the solidness of a stile-and-rail construction, each V-Groove door features a precision carved tongue-and-groove that gives the rustic appearance of a plank-style door.

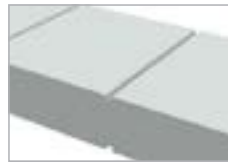

SQUARE GROOVE FLUSH PROFILE



STANDARD V-GROOVE FLUSH PROFILE



U-GROOVE FLUSH PROFILE



STANDARD V-GROOVE PROFILE



BEADED V-GROOVE PROFILE



www.archconceptsllc.com/v-groove-doors/

Custom Flush Doors

Our flush modern doors offer a sturdy, functional option for certain applications and aesthetic needs. Every one of our flush doors is engineered to resist warping and twisting. Depending on the size, most of our flush doors can be quite heavy.



SATIN ROSE GOLD



SATIN BRASS



POLISHED ROSE GOLD



POLISHED BRASS



SATIN STAINLESS



SATIN BLACK



POLISHED STAINLESS



POLISHED BLACK



3/8" STAINLESS INLAY



SQUARE GROOVE



www.archconceptsllc.com/flush-doors/





Louver Doors

Our striking louver doors provide not only unique style options, from traditional plantation style to coastal contemporary, but also serve a functional purpose as well, by offering both privacy and the airflow needed for certain rooms and spaces. Our louver panels are available in both vented and false configurations and can be added to most of our panel doors.

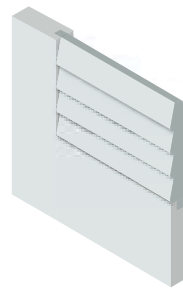

No Airflow

FALSE LOUVER

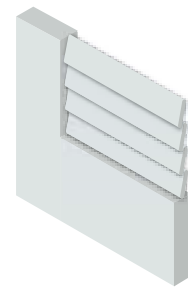

Airflow

VENTED LOUVER



www.archconceptslc.com/louver-doors/

Tambour Doors

The AC/DC Tambour Door blends classic stile and rail construction with advanced CNC routing—available in round or bevel styles—to create a sleek, modern aesthetic suited for today's contemporary spaces.

ROUND

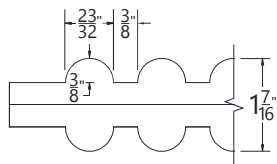

BEVEL

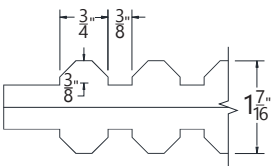

www.archconceptsllc.com/tambour-door/





Exterior Doors

**Any of our Doors can
become an Exterior Door**

We are incorporating Exterior MDF, with our Exterior Engineered Stiles to make an extremely durable door with unparalleled design flexibility.

Engineered Exterior Stiles and Rails which incorporate Armorite Exterior MDF and LSL Cores

Panels are made of Armorite Exterior MDF

Industry best Milesi Exterior Primer
Available for 1-3/4" and 2-1/4" doors
10 Year Limited Warranty

Milesi Exterior Pre-Finish available



STILEChoice[®]
By IHS Door Company[®]

Doors Make the
Difference[®]



stilechoice.com

Stile, Rail & Panel Profiles



We offer a multitude of rail widths and sizes, sticking profiles, and panel options. You can get exactly what you need to match your project, and everything made to the same exacting standards.

Stile & Rail Sticking

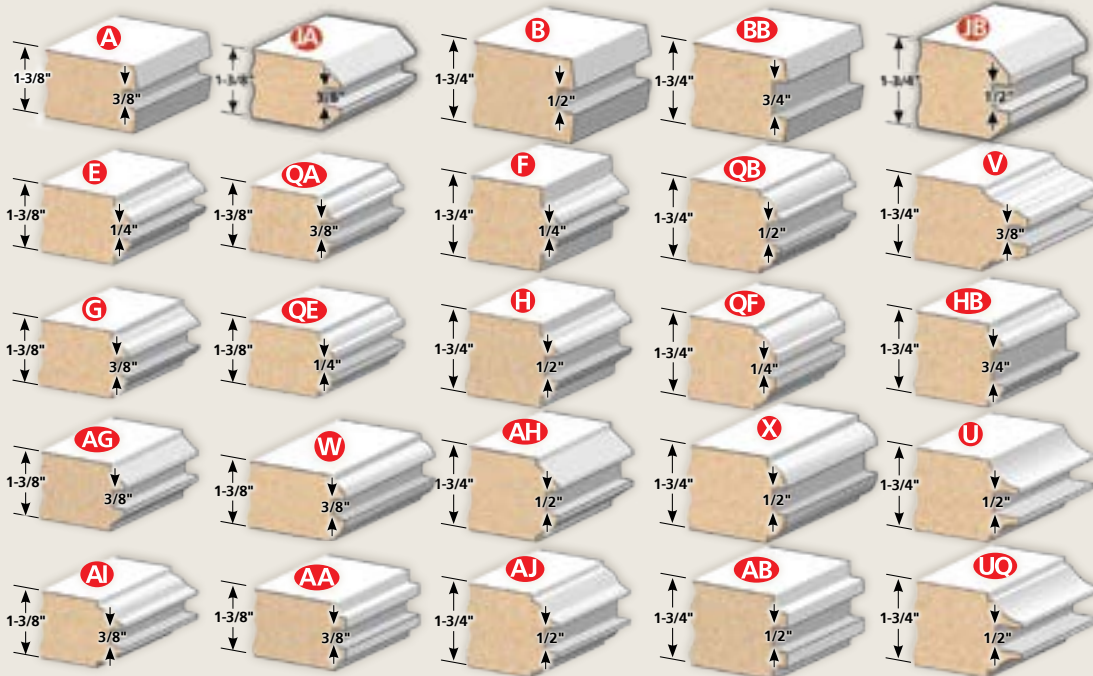

Panels

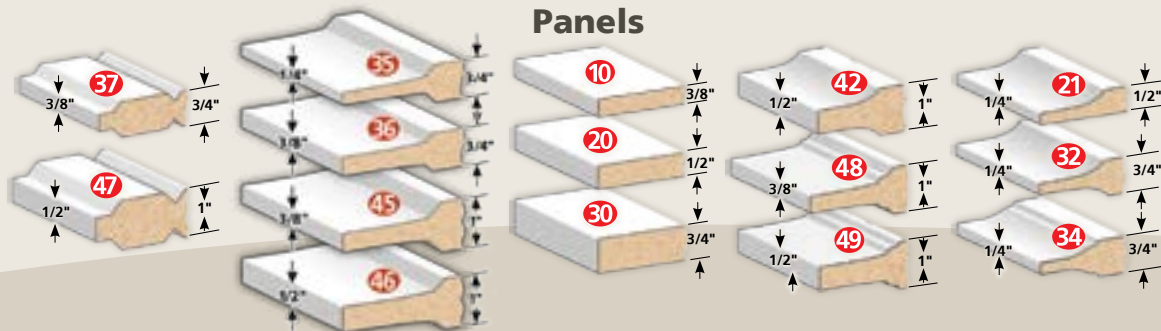

We keep it simple.

Because we only make one, exceptional product, we can be efficient, adaptive, and responsive to your needs. Big enough to do the job, small enough that we still hang our hat on personalized customer service.

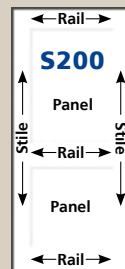

Specify the door you want

For example, choose:

Design..... **S200**

Stile & rail sticking..... **AJ**

Panel..... **49**

The order is **S200-AJ49**





Door Designs



Many of our doors are available as common arch pairs.



Many of the doors are available as common arch pairs



Don't see a style you like? Send us a sketch and we'll make it!



This is just a small sample of the many glass doors available

We do options.

Our customers are not limited to what's standard. We will custom mix sticking and panel choices to your needs.

- Standard for us is custom in most books. If we don't offer exactly what a customer wants, we'll create it for you.
- We do custom True Divided Lite (TDL) glass doors—to match our sticking profiles.



- We can add our standard chevron louvered door panels for an aesthetic effect to any architectural door. Flat louvers are also available.



STILEChoice
By IHS Door Company

Stile and Rail Primed MDF Interior Doors



GLASS★CRAFT®
DOOR COMPANY

SPECIAL ORDER ONLY

GLASSCRAFT (SPECIAL ORDER)

FIBERCRAFT® COMPOSITE DOORS



2 Panel Camber

36" wide Value Series mahogany textured door, shown here with:

- V-Grooved panels
- Tricorn Black painted finish



3/4 Lite Wide View

36" wide Value Series smooth, flush-glazed. Shaker style door, shown here with:

- Arcade White painted finish
- Water glass



3 Lite Wide SDL

36" wide Value Series smooth, flush-glazed door, shown with:

- Arcade White painted finish
- Clear LowE glass



3/4 Lite Urban

Shown as 36" wide mahogany textured door, with:

- Urban steel grille
- Smoke Grey finish
- Large Flemish glass



Craftsman 4 Lite GBG

36" wide Craftsman mahogany textured door, with:

- Metro glass frame / Clear glass
- 4 Lite aluminum GBG grid
- Grey Clouds painted finish



Full Lite 10 Lite SDL

Shown as 36" wide door, with:

- Smooth or mahogany texture
- Arcade White painted finish
- Clear glass

* Doors shown above are 95.25" tall, most are also available at 79.25", and in varied widths.



2 Panel Speakeasy

- Shown as 36" wide door, with:
- Premium or Pro Series
 - Canyon Brown Antique finish
 - Florentine Speakeasy Grille
 - Clear glass



NP 4 Block Left

- 36" wide Narrow Profile door shown here with:
- 4 Block Left configuration
 - Cloud Glass
 - Tricorn Black paint color



Santa Monica 4 Lite

- Shown as 36" wide door, with:
- Premium or Pro Series
 - Pro Metro frame glazed
 - European Oak Antique finish
 - Cloud glass option



3/4 SDL 6 Lite

- Shown as 36" wide door, with:
- V-Groove panel option
 - 1" wide muntin bars
 - Charcoal Distressed finish
 - Flemish glass texture



Craftsman 3 Panel

- Shown as 36" wide Value Series Shaker style door, with:
- Arcade White Palette Collection painted finish



Full Lite with Blinds

- Shown as 36" wide Value Series door, with:
- Arcade White Palette Collection painted finish
 - Clear LowE glass

* Doors shown above are 95.25" tall, most are also available at 79.25", and in varied widths.

GLASSCRAFT (SPECIAL ORDER)

WOODCRAFT® HARDWOOD DOORS



Brentwood V-Groove

Shown as 36" wide V-Grooved Portobello Mahogany door, with:

- Canyon Brown Antique finish
- Peep hole viewer option



Santa Barbara 1 Lite

36" wide Portobello Mahogany door, shown with:

- V-Grooved design
- Burnt Umber Traditional finish
- Reeds glass



Continental 5 Lite

36" wide DoorCraft Mahogany door, shown with:

- Charcoal Traditional finish
- Cloud glass



3/4 Lite Republic

36" wide Portobello Mahogany door, shown here with:

- Republic Wrought Iron grille
- Charcoal Traditional finish
- Rain glass



Craftsman 6 Lite SDL

36" wide 1 Panel DoorCraft Mahogany Craftsman door shown with:

- Whitewash Traditional finish
- Water glass



3/4 Lite 4 Lite TDL

36" wide DoorCraft Mahogany door, shown here with:

- Willow Grey Antique finish
- Large Flemish glass

* Doors shown above are 96" tall, most are also available at 80", and in varied widths.



2 Panel Speakeasy

Shown as 36" wide V-Grooved Estancia Knotty Alder door, with:

- Burnt Umber Traditional finish
- Seville speakeasy grille
- Rain glass



3/4 Lite Mahogany

36" wide Portobello Mahogany door, shown with:

- Raised moulding standard
- Charcoal Traditional finish
- Reeds glass



Beverly 6 Lite

36" wide Portobello Mahogany door, shown with:

- Willow Grey Antique finish
- Water glass



3/4 Lite Warwick

36" wide Portobello Mahogany door, shown here with:

- Warwick Wrought Iron grille
- Sweet Honey Antique finish
- Antique glass



Craftsman 4-Lite

36" wide 3 Panel Mahogany SDL door shown with:

- Willow Grey Traditional finish
- Dentil Shelf option
- Clear glass



6 Lite TDL

36" wide Estancia Knotty Alder door, shown here with:

- Canyon Brown Traditional finish
- Antique glass

* Doors shown above are 96" tall, most are also available at 80", and in varied widths.





DOOR & MILLWORK

PATIO DOORS

ATRIUM (SPECIAL ORDER)

SERIES 312 - SLIDING PATIO DOOR



SERIES 312 SLIDING PATIO DOOR

- + Offered in range of sizes: 5', 6', 6'4", 8', 9', even 12'
- + Custom sizes available
- + Available in 6'8" height up to 12' wide
- + Field reversible (not available with BBG)
- + Aluminum track for moving panel
- + Easy installation in new construction applications
- + Screen comes standard*
- + Deluxe color-matched hardware
- + Keyed lock standard

CUSTOM Options

- + Low-E Glass
- + Low-E Glass + Argon Gas
- + Ultra Low-E Glass + Argon Gas
- + 1/2" or 3/4" flat, 1/2" or 1" contoured, 3/4" contoured valance and distinctive diamond pattern grids available
- + 1 1/2" Simulated Divided Lite
- + Light and dark shades of oak or cherry interior wood laminate and black exterior laminate
- + Side lites; transoms and specialty shapes; upgraded, deluxe heavy-duty screen*
- + Pet resistant screen*
- + Brass, brushed nickel or oil rubbed bronze hardware
- + Available in 5', 6', 6'4", 8', 9', and 12' configurations



BLINDS Between the Glass Option

Available in 6068 with white, almond and clay vinyl, interior and exterior laminates and painted exterior colors. Blinds, operators and glass panels available in white only.

NEW Also available in 5068 (white only)

NEW black exterior laminate color shown with optional blinds between the glass laminate in 6068 only.



Easy to raise, lower and tilt blinds.



Controls light and privacy.



Never needs dusting and is safe for pets and children.

VINYL COLOR** OPTIONS



PAINTED EXTERIOR COLOR** OPTIONS



WOOD LAMINATE COLOR** OPTIONS



Select styles and glass packages can be ordered to meet ENERGY STAR® 7 guidelines. See your Atrium Territory Sales Manager for details.

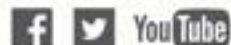

Note: Manufacturer reserves the right to substitute components, as necessary for continued product improvement.
 *Screens are not meant to retain a child from falling through an open window.
 **Printing process may affect color shown. Please refer to actual window sample when selecting color.
 ***Get shoring bracket to 5/8" contoured or SDL on exterior painted windows. Only use mill, water based household cleaner on painted product and rinse thoroughly with water. See full cleaning instructions for details. REV 11/23

PART OF THE CORNERSTONE BUILDING BRANDS FAMILY

SERIES 332
SLIDING PATIO DOOR

- + Easy installation in new construction applications with built-in 4 9/16" jamb
- + Field reversible (6'8" height only; not available with BBG)
- + DP-50 Rating great for coastal applications (on 5068, 6068 and 8068 doors)
- + Deluxe color matched hardware
- + Custom sizes available
- + Multi-Point keyed lock
- + Available in 8' height
- + Available in 6'8" height up to 12' wide
- + Heavy-Duty Screen included*
- + Limited Lifetime Warranty



CUSTOM Options

- + Low-E Glass
- + Low-E Glass + Argon Gas
- + Ultra Low-E Glass + Argon Gas
- + 5/8" or 3/4" flat, 5/8" or 1" contoured, 1 1/8" Simulated Divided Lite grids available
- + Nine exterior painted colors, three interior wood laminates, black exterior laminate
- + Brass, brushed nickel or oil rubbed bronze hardware
- + Pet resistant screen**



BLINDS Between the Glass Option

Available in 6068 with white, almond and clay vinyl, interior and exterior laminates and painted exterior colors. Blinds, operators and glass panels available in white only.

NEW black exterior laminate color shown with optional blinds between the glass.



Easy to raise, lower and tilt blinds.



Controls light and privacy.



Never needs dusting and is safe for pets and children.

Select styles and glass packages can be ordered to meet ENERGY STAR® 7 guidelines. See your Atrium Territory Sales Manager for details.



Note: Manufacturer reserves the right to substitute components, as necessary for continued product improvement.
 *Screens are not meant to retain a child from falling through an open window.
 **Printing process may affect color shown. Please refer to actual window sample when selecting color.
 ***Get shoring brackets to 5/8" contoured or SDL on exterior painted windows. Only use mill, water based household cleaner on painted product and never directly with water. See full cleaning instructions for details. REV 11/23

V2000 PATIO DOOR

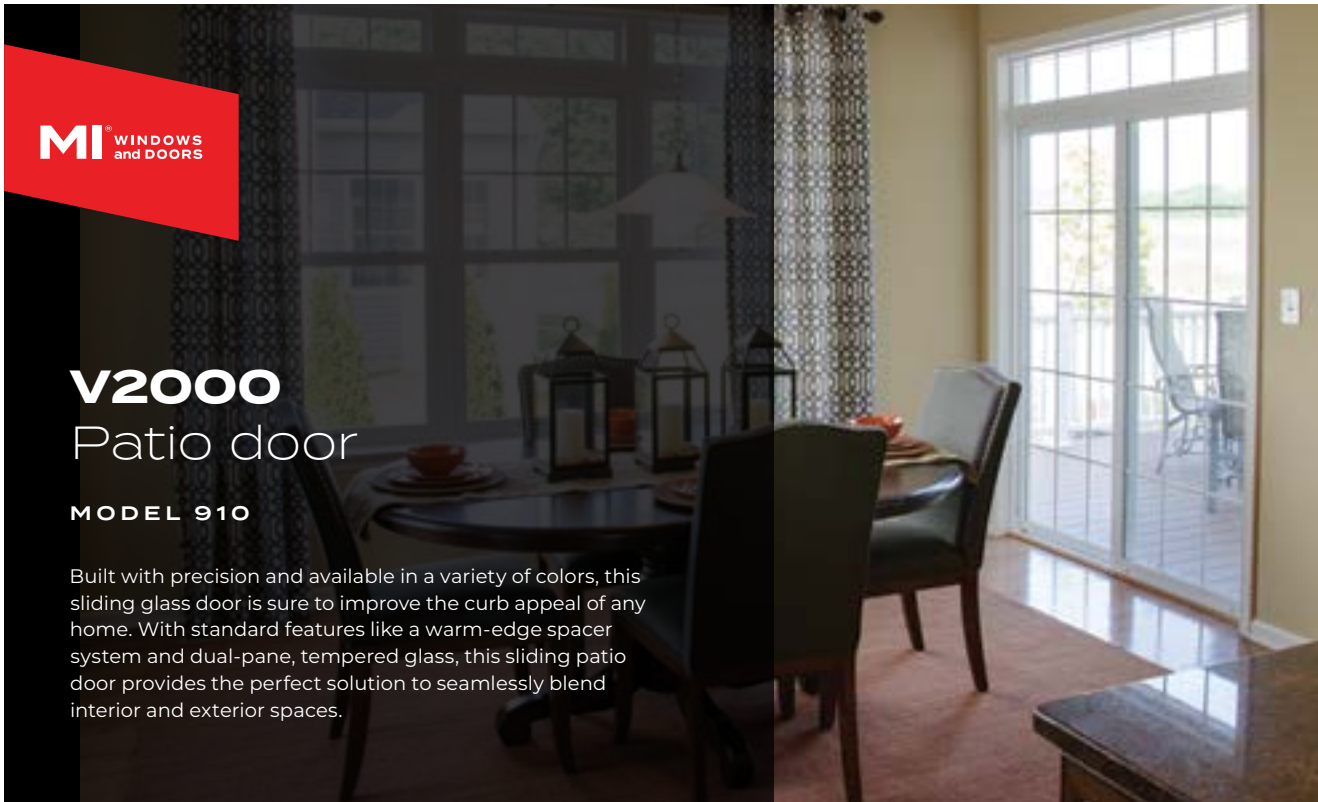

MI[®] WINDOWS
and DOORS

V2000 Patio door

MODEL 910

Built with precision and available in a variety of colors, this sliding glass door is sure to improve the curb appeal of any home. With standard features like a warm-edge spacer system and dual-pane, tempered glass, this sliding patio door provides the perfect solution to seamlessly blend interior and exterior spaces.



What you can expect

ENERGY EFFICIENCY

Our dual-pane insulated glass package options help save on heating and cooling costs while enhancing home comfort.

- In cool weather, it provides outstanding thermal performance to eliminate cold spots near windows.
- In warm weather, insulated glass reduces solar heat gain and minimizes interior glare.

CONVENIENCE AND STYLE

- Metal rollers with tandem ball bearings provide for smooth, effortless operation
- Aluminum roll panel track is sturdy and easy to clean
- Panel interlock helps reduce air infiltration
- Insulated double-strength tempered glass adds strength and dependability
- Optional exterior key lock increases peace-of-mind and convenience

Engineered to perform

- Available frame styles: mounting fin, finless
- 4 ¾" frame depth
- J-channel and brickmould options available

Energy efficient glass

Optional tempered glass adds additional strength and obscure or rain glass allows light in while protecting privacy.

GLAZING TYPE	U-VALUE	SHGC
Low-E glass	0.32	0.32
Low-E glass with grids	0.32	0.28
Argon and Low-E glass	0.28	0.32
Argon and Low-E glass with grids	0.28	0.28
HP Low-E glass	0.32	0.23
HP Low-E glass with grids	0.32	0.21
Argon and HP Low-E glass	0.28	0.23
Argon and HP Low-E glass with grids	0.28	0.21
Thermal Upgrade: Argon Low-E glass	0.28	0.32
Thermal Upgrade: Argon and Low-E glass with grids	0.28	0.28

Note: all values based on ¾" standard dual-pane insulated glass unit unless noted otherwise

Sizing & operation

PANELS	PANEL OPERATION View from Outside In	STANDARD SIZES		CUSTOM SIZES			
		WIDTH		WIDTH		HEIGHT	
		CODE	EXACT	MIN	MAX	MIN	MAX
2-Panel		(50)	59 5/8"	47 1/2"	95 5/8"	71"	95 1/2"
		(60)	71 5/8"				
		(80)	95 5/8"				
Field-Mulled Sidelite		(26)	29 1/4"	12"	48"	71"	95 1/2"
		(30)	35 1/4"				
		(40)	47 1/4"				
X=operating; O=stationary; S=sidelite		Available heights (6/8) 79 1/2" (8/0) 95 1/2"					

Create a customized look

Enhance your home's spaces with a variety finish options and grid configurations.

FINISH OPTIONS

EXTERIOR	INTERIOR
White EXTRUSION	White EXTRUSION
Almond PAINT ◊ / EXTRUSION	Almond EXTRUSION †
Clay PAINT ◊ / EXTRUSION †	Clay EXTRUSION †
Cocoa PAINT ◊	
Cream PAINT ◊	
Forest Green PAINT ◊	
Bronze LAMINATE † / PAINT ◊	
Black Matte LAMINATE † / PAINT ◊	

GRID TYPES

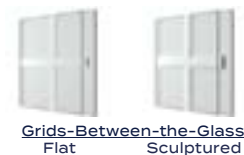

HARDWARE OPTIONS

COLOR-MATCHED TO DOOR FRAME

- White
- Almond
- Clay
- Silver exterior (for paint)
- Black exterior (for laminate)

V2000 PATIO DOOR
See additional product and warranty information online.



† Exterior laminate available with white interior only; has a satin finish (matte applies to black paint only)
◊ Exterior paint not available with brickmould

MI[®] Build boldly by choosing a range of MI window and door styles with expansive views, contemporary framing and hardware.

V3000 PATIO DOOR

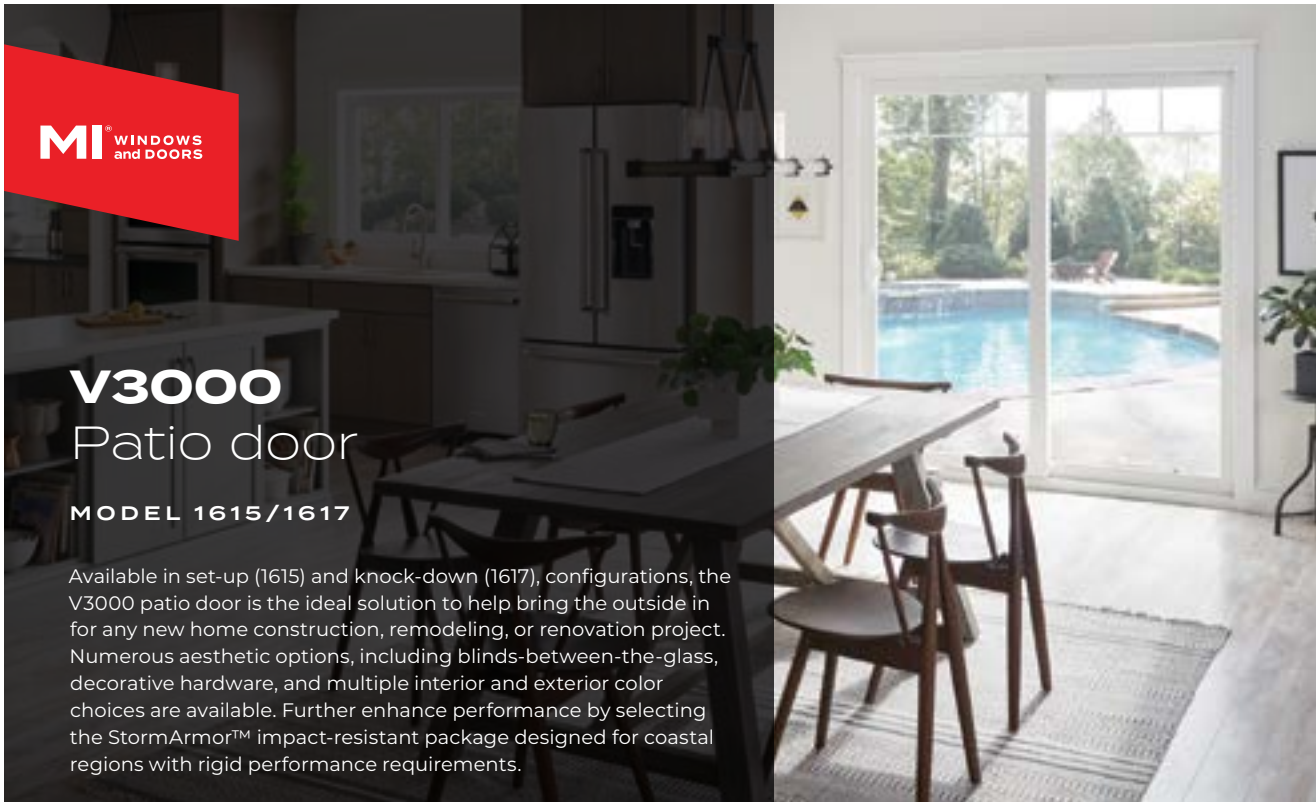

V3000 Patio door

MODEL 1615/1617

Available in set-up (1615) and knock-down (1617), configurations, the V3000 patio door is the ideal solution to help bring the outside in for any new home construction, remodeling, or renovation project. Numerous aesthetic options, including blinds-between-the-glass, decorative hardware, and multiple interior and exterior color choices are available. Further enhance performance by selecting the StormArmor™ impact-resistant package designed for coastal regions with rigid performance requirements.



What you can expect

ENERGY EFFICIENCY

Our dual- and triple-pane insulated glass package options help save on heating and cooling costs while enhancing home comfort.

- In cool weather, it provides outstanding thermal performance to eliminate cold spots near windows.
- In warm weather, insulated glass reduces solar heat gain and minimizes interior glare.

CONVENIENCE AND STYLE

- Saddle sill with heavy-duty dual tandem nylon rollers provide for smooth, effortless operation
- Raised rail protects wheels from debris
- Aluminum track is sturdy and easy to clean
- Panel interlock helps reduce air infiltration
- Insulated double-strength tempered glass adds strength and dependability
- Dual-point mortised lock for enhanced safety
- Optional foot lock, security bar, and exterior key lock increases peace-of-mind and convenience

Engineered to perform

- Available frame styles: finless, sealing fin
- 4 3/16" frame depth (5 3/8" including screen track)
- Optional StormArmor™ package includes impact-resistant glass with argon, Cardinal LoE³-366, and preserve film to protect the glass until installation is complete
- Optional DP-50 package on select configurations



Energy efficient glass

Standard tempered glass adds additional strength and allows light in while protecting privacy.

GLAZING TYPE	U-VALUE	SHGC	STC
Argon and Low-E glass	0.29	0.28	29
Argon and Low-E glass with grids	0.29	0.25	29
Argon and HP Low-E glass	0.29	0.20	29
Argon and HP Low-E glass with grids	0.29	0.18	29
Triple-pane with argon and Low-E glass	0.25	0.24	n/a
Triple-pane with argon and Low-E glass with grids	0.27	0.22	n/a
Impact-resistant laminated glass with Argon and LoE ³ -366	0.33	0.20	24
Impact-resistant laminated glass with Argon , LoE ³ -366 with grids	0.36	0.18	24
Impact-resistant laminated glass with Argon and LoE ³ -340	0.33	0.14	24
Impact-resistant laminated glass with Argon , LoE ³ -340 with grids	0.36	0.13	24

Note: all values based on 7/8" standard dual-pane or 1" dual-pane laminated insulated glass unit unless noted otherwise

Sizing & operation

PANELS	PANEL OPERATION View from Outside In	STANDARD SIZES		CUSTOM SIZES			
		WIDTH		WIDTH		HEIGHT	
		CODE	EXACT	MIN	MAX	MIN	MAX
2-Panel		(50)	58 7/8"	52"	96"	63"	95 1/2"
		(60)	70 7/8"				
		(80)	94 1/2"				
3-Panel		(90)	106 1/4"	80"	142"	63"	95 1/2"
		(120)	141 1/4"				
3-Panel*		(90)	103 1/2"	80"	139"	63"	95 1/2"
		(120)	138 1/4"				
4-Panel*		(100)	115 7/16"	96"	187 3/4"	63"	95 1/2"
		(120)	139 7/16"				
		(160)	186 1/4"				

*Available as 1617 knockdown only

X=operating; O=stationary

Available heights
(68) 79 1/2" or (80) 95 1/2"

= Available with StormArmor

† Clay interior may only be combined with clay extruded exterior; not available with triple-pane glass

‡ Woodgrain interior not available with black or clay exterior

§ Blinds-between-the-glass available for dual-pane glass only; not available with StormArmor; available in white color only

* Standard handles are color-matched to door frame; black handle is available for exterior only and must be combined with white interior handle; brushed chrome is standard on painted and laminated products

‡ XX Recessed exterior black handle standard

V3000 PATIO DOOR
See additional product and warranty information online.



Create a customized look

Enhance your home's spaces with a variety of finish options and grid configurations.

FINISH OPTIONS

EXTERIOR

INTERIOR

White EXTRUSION	White EXTRUSION
Almond PAINT / EXTRUSION	Almond EXTRUSION
Clay PAINT / EXTRUSION	Clay EXTRUSION†
Cocoa PAINT	Hillside Oak LAMINATE ‡
Cream PAINT	Natural Oak LAMINATE ‡
Forest Green PAINT	Colonial Cherry LAMINATE ‡
Bronze PAINT	
Black Matte PAINT	
Silver PAINT	

GRID AND BLIND TYPES

Grids-Between-the-Glass Flat	Grids-Between-the-Glass Sculptured	Blinds-between-the-glass*

HARDWARE OPTIONS*

	<ul style="list-style-type: none"> • White • Almond • Clay 		<ul style="list-style-type: none"> • Brushed Chrome • Bright Chrome • Brass • Black Nickel • Black • White
Standard		Enhanced	

ADDITIONAL FEATURES*

	<ul style="list-style-type: none"> • Black ‡ 		<ul style="list-style-type: none"> • White • Almond • Clay • Black
Recessed		Foot Lock	

MI[®] Build boldly by choosing a range of MI window and door styles with expansive views, contemporary framing and hardware.





DOOR & MILLWORK

PREMIUM PATIO DOORS

NEUMA DOORS (SPECIAL ORDER) PATIO DOORS



Neuma Doors is your source for beautiful, durable fiberglass exterior doors. We offer a variety of doors including hinged, gliding, bypass gliding, and folding doors with glass options including impact for those in coastal and non-impact for those away from the coast.

With a full composite jamb and fiberglass skin, Neuma Doors are designed for better water infiltration protection than standard wood jamb doors. Built with a solid core and using LoE 366 glass standard, you get a very energy-efficient door providing better insulation against hot and cold temperatures outside.

Take a tour of our website to see more about our offerings and visit your local dealer to learn more about adding Neuma Doors to your next project.



WWW.NEUMADOORS.COM |

MASONITE (SPECIAL ORDER)

MIRAVISTA FOLDING DOOR SYTEM



The MiraVista Folding Door System transforms basic patio doors or exterior walls into dynamic openings, seamlessly blending indoor and outdoor living. MiraVista is a kit of components that enables 1-3/4" standard fiberglass door panels to become a customizable folding door system. Whether openings are 6/8 or 8/0, an innovative sliding track with specialized components delivers simple, seamless operation.

Features and Benefits

Versatile – The system is designed for new construction AND is perfect for remodels and retrofits. It doesn't require more top supports than a standard sliding door, because the weight of the door panels is held by the sliding track.

No special panel routing – Standard 1-3/4" Thick Fiberglass Door Panels can be used to build a MiraVista Folding Door System without any modifications or routing to the panels.

Solves imperfections in rough openings – The MiraVista knuckles can move up and down as well as side to side. Doors can be aligned to be square and plumb during installation and during use.

Easy operation – To open MiraVista, simply flip the levers to unlock the top and bottom bolts on the movable panels.

Outstanding Performance – Looks great, works better. Up to DP75 Structural and DP20 Water Performance in a 3-panel MiraVista System using Masonite VistaGrande Fiberglass Panels, when testing to ASTM Standards.

Multi-point security – Pairs perfectly with PanoLock+ for security and even higher performance.

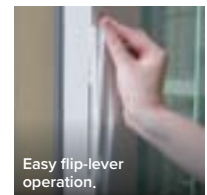
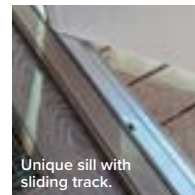
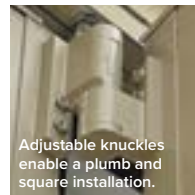

Availability and Options

Unit Width:

Up to (3) 3/0 Panels
Max Sill Length: 115"

Unit Height:

6/8 or 8/0

Sill Width Options:

5-5/8" or 7-5/8"

Height:

6/8 or 8/0

Finish Options:

Upper Track, Side Casing & Hinge Bars:
White and Black

Sill Caps: Walnut and Black

Sill Decks: Mill and Bronze



Left Hand Outswing,
Right Hand Stack Unit Shown

Right Hand Outswing,
Left Hand Stack Unit Shown

Upper Track, Side Casing, Hinge Bar Finishes



Black White

Sill Cap Finishes



Walnut Black

Sill Deck Finishes



Bronze Mill

WINDOR (SPECIAL ORDER)

3750 MULTI-SLIDE SYSTEM



Features and Benefits

■ Sizing

- Standard sizing in 9', 12', and 15' x 8' in 3 panel Configuration.
- Standard sizing in 12', 16', and 20' x 8' in 4 panel Configuration.
- Maximum panel size is 5' x 8' or 40 sq ft.
- Maximum frame width of 3 panel door system at 15'.
- Maximum width of 4 panel door system at 20'.
- Custom sizing available.

■ Frame

- KD or welded main frame.
- 7 $\frac{3}{4}$ " total width 6 $\frac{3}{4}$ " jamb depth all PVC multi-chambered profile frame system (on 3 panel).
- 10 $\frac{3}{8}$ " total width 9 $\frac{3}{8}$ " jamb depth all PVC multi-chambered profile frame system (on 4 panel).
- Integrated nail fin application with 1" or 1 $\frac{3}{8}$ " set back.
- Full length weather stripping on all 4 frame components.
- Integrated sill drainage with snap-in sill covers.

■ Sash

- Fully welded vinyl sash with internal aluminum reinforcement with $\frac{7}{8}$ " standard IG, or a 1 $\frac{1}{4}$ " triple insulated glass system.
- Many high energy-efficient glass options for the most extreme temperature sensitive regions.
- Standard glazing, Cardinal™ LoE 366® dual glazed tempered glass.
- All stiles are metal reinforced for extreme wind load resistance.
- Unique internal drainage system to minimize risk of seal failures.
- Interior glazed for better performance.

■ Hardware

- Truth Nexus 2 point lock with opposing lock points.
- Anti-lock feature preventing a "false" sense of lock up.
- Flush mount handle - does not protrude into the room.
- Deep finger pocket - provides superior grip area for moving large door panels.
- Recessed thumb slide intuitive locking and unlocking of panel.
- Stainless steel roller housing and composite wheels with side adjustment, AAMA rated to carry a 500 pound panel for 10,000 cycles without change to adjustment.
- Hardware colors; white, black powder coat, and brushed chrome.

■ Extruded Vinyl Colors



■ Optional Exterior Coated Stocked Colors



■ Optional

- Black Interior and Exterior Specialty Laminate
Featuring **WINSHIELD** Jet Black



Signature

Flush Mount



www.windorsystems.com



V3000 Multi-slide patio door

MODEL 1618

Opening up to 17 feet wide, the V3000 multi-slide patio door is the ideal solution to effortlessly blend interior and exterior spaces for new home construction, remodeling, or renovation projects. Numerous aesthetic options including decorative hardware and multiple interior and exterior color choices are available.



What you can expect

ENERGY EFFICIENCY

Our dual- and triple-pane insulated glass package options help save on heating and cooling costs while enhancing home comfort.

- In cool weather, it provides outstanding thermal performance to eliminate cold spots near windows.
- In warm weather, insulated glass reduces solar heat gain and minimizes interior glare.

CONVENIENCE AND STYLE

- Saddle sill with heavy-duty dual tandem nylon rollers provide for smooth, effortless operation
- Raised rail protects wheels from debris
- Aluminum track is sturdy and easy to clean
- Panel interlock helps reduce air infiltration
- Insulated double-strength tempered glass adds strength and dependability
- Dual-point mortised lock for enhanced safety
- Optional foot lock, security bar, and exterior key lock increases peace-of-mind and convenience

V3000 MULTI-SLIDE PATIO DOOR

Engineered to perform

- Available frame styles: finless, fin
- 6 7/8" frame depth
- Optional StormArmor™ package on XIX configurations
- Optional DP-50 package on select configurations



Energy efficient glass

Standard tempered glass adds additional strength and allows light in while protecting privacy.

GLAZING TYPE	U-VALUE	SHGC
Argon and Low-E glass	0.29	0.28
Argon and Low-E glass with grids	0.29	0.25
Argon and HP Low-E glass	0.29	0.20
Argon and HP Low-E glass with grids	0.29	0.18
Triple-pane with argon and Low-E glass	0.25	0.24
Triple-pane with argon and Low-E glass with grids	0.27	0.21
Impact-resistant laminated glass with Argon and LoE ³ -366	0.31	0.20
Impact-resistant laminated glass with Argon , LoE ³ -366 with grids	0.33	0.18
Impact-resistant laminated glass with Argon and LoE ³ -340	0.31	0.14
Impact-resistant laminated glass with Argon , LoE ³ -340 with grids	0.33	0.12

Note: all values based on 7/8" standard dual-pane or 1" dual-pane laminated insulated glass unit unless noted otherwise

Sizing & operation

PANELS	PANEL OPERATION View from Outside In	STANDARD SIZES		CUSTOM SIZES			
		WIDTH		WIDTH		HEIGHT	
		CODE	EXACT	MIN	MAX	MIN	MAX
3-Panel		(72)	86"				
		(88)	104"	80"	144"	63"	95 1/2"
		(120)	139 7/16"				
6-Panel		(140)	169 1/4"	160"	216"	63"	95 1/2"
		(170)	205 1/8"				
X = operating; O = stationary; I = intermediate		Available heights (68) 79 1/2" (80) 95 1/2"					

* Screens are not available on XIX configuration

* Standard handles are color-matched to door frame; black handle is available for exterior only and must be combined with white interior handle; brushed chrome is standard on painted and laminated products

§ Blinds-between-the-glass available for dual-pane glass only; available in white color only

V3000 MULTI-SLIDE DOOR
See additional product and warranty information online.



Create a customized look

Enhance your home's spaces with a variety of finish options and grid configurations.

FINISH OPTIONS

EXTERIOR	INTERIOR
White EXTRUSION	White EXTRUSION
Clay PAINT	
Cocoa PAINT	
Cream PAINT	
Forest Green PAINT	
Bronze PAINT	
Black Matte PAINT	
Silver PAINT	

GRID TYPES



HARDWARE OPTIONS*

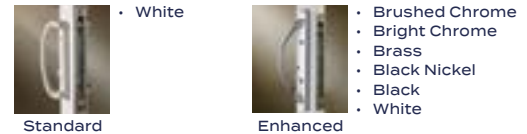

ADDITIONAL FEATURES*



MI Build boldly by choosing a range of MI window and door styles with expansive views, contemporary framing and hardware.

Sliding Glass Door



Ease of Operation

Stainless-steel rollers for smooth and durable movement



Exceptional Quality

PGT® WinGuard® is #1 in quality patio doors in America*

SGD5570

Preferred Sliding Glass Door

Configurations

- 4,5" Interlock
- Bypass, Pocket, and Corner
- Up to 8 panels with expansions of up to 40'

Dual-Point Locking System

- Prevents panels from being lifted off the tracks
- Secures into the door jamb, creating a weather-tight seal with high-security performance and maximum-load resistance

Screens

- Standard or heavy-duty

Dimensions

- Max panel size: 5'w x 10'h



PGT CUSTOM DOORS (SPECIAL ORDER)

SLIDING GLASS DOOR



SGD5570 Track Height Dimensions



Standard 1.680" height

Optional 1.5" height allows tracks to be inset at floor level*

Optional 3.25" and 4" guards against water intrusion

Sill Risers: 2.5", 3.5", 4.0625", 4.625"

*The 1.5" height may only be used where water infiltration resistance is not required per the building code.

SGD5570 Roller Options



Stainless Steel

Nylon for a quieter option

Steel (*Standard*)



SGD5570 Preferred Sliding Glass Door
2 panel bypass

French Door



Ease of Operation

Heavy-duty hinge supports the weight of the door for easy opening



Exceptional Quality

PGT® WinGuard® is #1 in quality patio doors in America*

FD5555

Preferred French Door

Configurations

→ Available as a double French Door style or single French Door (*also known as a patio or terrace door*)

Modular Design

→ Single or double configurations
→ Optional sidelites and transoms allow design flexibility

3-Point Stainless-Steel Locking System

→ Provides an unmatched level of strength and security

Prepped for Industry-Standard Hardware

→ Enhances the design of patios, master bedrooms, and more



* Builder Brand Use Report, 2019

FRENCH DOOR

SLIDING GLASS DOOR HARDWARE OPTIONS

Raised



- White
- Black
- Satin Nickel
- Oil-rubbed Bronze
- Beige

Contemporary



- White
- Black
- Satin Nickel

Curved



- White
- Black
- Satin Nickel
- Beige

FRENCH DOOR HARDWARE OPTIONS

Series 100



- Satin Nickel
- Oil-rubbed Bronze

Series 800



- Satin Nickel
- Oil-rubbed Bronze

Contemporary



- Satin Nickel
- Oil-rubbed Bronze

FRAME COLORS

Powder-coated frames resist chipping, corrosion, and fading. Custom frame colors are also available. Multi-chambered frame provides outstanding energy savings.

- Black**
- Bronze**
- Beige**
- White**

SCREENS

Fiberglass Screen Mesh

-  18x16
Charcoal or Gray

BetterVue[®] (Optional)
Insect screening with
Water Shed Technology[™]



FRENCH DOOR

GLASS OPTIONS

With over 7,200 glazing options possible, you can create the right look for any window shape, size, or style. WinGuard® Vinyl products offer superior energy efficiency and many options to achieve ENERGY STAR® ratings with customized glass options like gas fills, tints, and coatings.

Argon Gas

(Laminated insulating glass only)

Windows can be filled with colorless and odorless argon gas to help insulate a room and minimize the transfer of heat through the window

Low-E (Emissivity) Glass

High performance coated glass that reflects and filters heat to keep your home comfortable

Impact Laminated Glass

Laminated glass for effortless impact resistance

Impact Laminated Insulating Glass

Highly customizable option that delivers increased energy efficiency and sound dampening

Privacy Glass

White Interlayer, Obscure glass, Obscure with White Interlayer, or Textured glass options

GRID TYPES

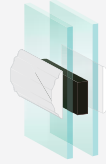

Traditional Simulated Divided Lite Grid

7/8" wide raised ogee applied to exterior and interior with 9/16" wide bronze shadow bar



Flat Grid

9/16" wide or 13/16" wide grid between the glass



Contour Grid

1" wide grid between the glass

GLASS TINTS



Clear



Bronze



Gray



Green



Azure Blue



Solarcool® Bronze



Graylite® II



Turtle Glass

Tinted to reduce light and protect the natural habitat of marine turtles. Ask your dealer to learn more.

GRID STYLES



None

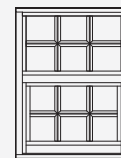

Colonial

(Many options available)

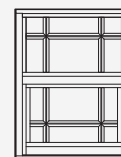

Brittany / Prairie



Multi-Slide Door
Aluminum



Create the true experience of indoor outdoor living with industry-leading aluminum multi-slide patio doors.
Our high-performance stacking multi-slide patio doors feature narrow, uniform sightlines to help you achieve your exact project vision.

SPECIFICATIONS

Panel Sizes

- Width: Min 24", Max 72"
- Height: Min 60", Max 144"

Frame Sizes

- Width: Min 43.5", Max 360"
- Height: Min 60", Max 144"

Configurations

- 2 to 5 one-way stacking panels
- Additional configurations to come

Attachment Method

- Block Frame

Performance

- PG 20
- U-factor 0.28-0.32
- SHGC 0.22

Sills

- Flush – 3/4"
- Performance – 1-1/2"

Stucco Returns

- 1"
- 1-3/8"

Sightline

- 2.43"

FRAME FINISHES



Satin Anodized



Black Anodized

HARDWARE

- Contemporary Pull
- Flush Handle
- Premium Adjustable Quad Rollers

HARDWARE FINISH OPTIONS



Satin Nickel (F42-R)



Matte Black (F9714)



Pivot Door
Aluminum



Add timeless sophistication to your design with the true modern styling of a Bonelli aluminum pivot door. With superior performance and options for every design, our pivot door solutions achieve your design vision without compromise.



SPECIFICATIONS

5mm Insulating Glass Sizes*

- Max: 5'x9', 4.5'x10'

6mm Insulating Glass Sizes*

- Max: 5'x8', 180lbs.

* Larger sizes coming soon

Product Dimensions

- Standard: 5-1/4" bottom rail with 3-1/4" stiles and top rail
- Custom: 5-1/8" stiles and top rail

Configurations

- Left- or right-handed
- Interior or exterior pivot

Attachment Method

- Block Frame

Structural Performance

- DP 30

FRAME FINISHES

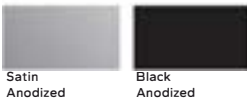

Satin Anodized

Black Anodized

HARDWARE

- Standard: 48" or 72" Ladder Pull
- Roller Catches with Deadbolt
- FritsJürgen Pivot System
- Custom: Electronic Deadbolt

HARDWARE FINISH OPTIONS



Satin Nickel (F42-R)

Matte Black (F9714)



IRON ENVY

IRON DOORS



Be the Envy of your neighborhood with a new Iron Envy door from McCoy's

Iron Envy offers the finest handcrafted iron doors on the market. Our skilled artisans have over 25 years of experience. Choose from our in-stock options or create a custom design to fit your own personal style.

All Iron Envy styles are available in Straight, Eyebrow and Radius top configurations. Most standard sizes are in stock and available within 5-7 Business Days. Custom ordered styles and sizes are available within 12- 14 Weeks. See your McCoy's sales associate for details and availability.



3068 Unit
Dim. 39"x81" - 6" Jamb
(Handlesets Not Included)

3080 Unit
Dim. - 39"x96" - 6" Jamb
(Handlesets Not Included)

3680 Unit
Dim. - 46"x96" - 8" Jamb
(Handlesets Not Included)



IRON ENVY



6080 Unit / Dimensions 72"x96" – 8" Jamb (Handlesets Not Included)

All single and double doors are available in Straight Top, Eyebrow, and Full Radius styles.

CUSTOM DESIGNS

Let us make your door dreams a reality. We can create any size, design or configuration for your door, transom, sidelights, or wine door.

Vision Steel

Iron Envy's European inspired Vision Steel line is the perfect option for any design. The ultra-slim profile allows for maximum glass viewing area.

The Vision Steel line comes standard with clear dual paned Low-E glass for maximum energy efficiency. Reflective, Sandblast, Smoke, and Tea colored glass is also available for custom orders.



Choose from our stock designs or let us create a custom "Vision" just for you. See your McCoy's sales associate for custom orders or to see available inventory.





COMMERCIAL DOORS

THERE'S MORE TO TELL ...

GALVANNEALED STEEL

Our metal doors and frames are made from galvanized steel.

What's galvanized steel and why?

We've all heard of galvanized steel. It's a process to create a corrosion resistant layer of protective zinc on steel. It's extremely common, durable, and reliable. Galvanized steel is different in that it is processed at a much higher temperature than galvanized steel. At the higher temperature, the iron in the steel combines with the projective zinc layer to create a zinc-iron alloy coating. As a result, galvanized steel is harder and stronger than galvanized steel, easier to weld and the surface is a matte finish that's more consistent and easier to paint on.



LITE KIT

We have an assortment of lite kits to choose from.

Let us know how you like the door.

Our lite kit frames are powder coated for improved corrosion resistance compared to conventional paint finishes. Powder coating is a process where charged powder is sprayed onto the grounded frames, binding evenly to the applied surface. It's then cured to create a robust surface finish that's durable and longer-lasting than conventional paint finishes.

TELL HARDWARE

Our selection of hardware gives you the security options you need.

Rest at ease knowing the door is secure.

Tell products are a smart way to minimize the risks of property damage and theft and help ensure safety in your modular buildings. For high-traffic, high-use applications, Tell locksets, door closers, exit devices and hardware are the right commercial solutions. Our products are proven performers, offering the ideal combination of quality, durability and security.



SPARTAN DOORS

ABOUT THE PRODUCT

The **Spartan Series Doors** are designed to meet the architectural requirements for hollow metal doors. This premium door construction combines the strength and dimensional stability of steel with the structural integrity of the polystyrene core. The continuous bonding of core to metal provides an attractive flat door, free of face welding marks. Windstorm Tests have proven that the Spartan door has integral high resistance to impact damage, low thermal conductivity, and high STC ratings. To meet application, specification and performance requirements, the Spartan offers a wide range of specifiable options including sizes, glass lite designs, hardware (mechanical, pneumatic, electrical) preparations and edge constructions.

Polystyrene core system enhances the structural integrity of the door, while significantly reducing the weight.

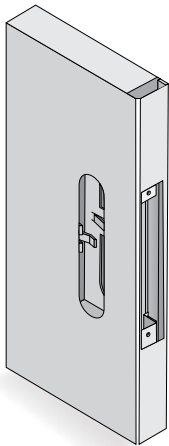
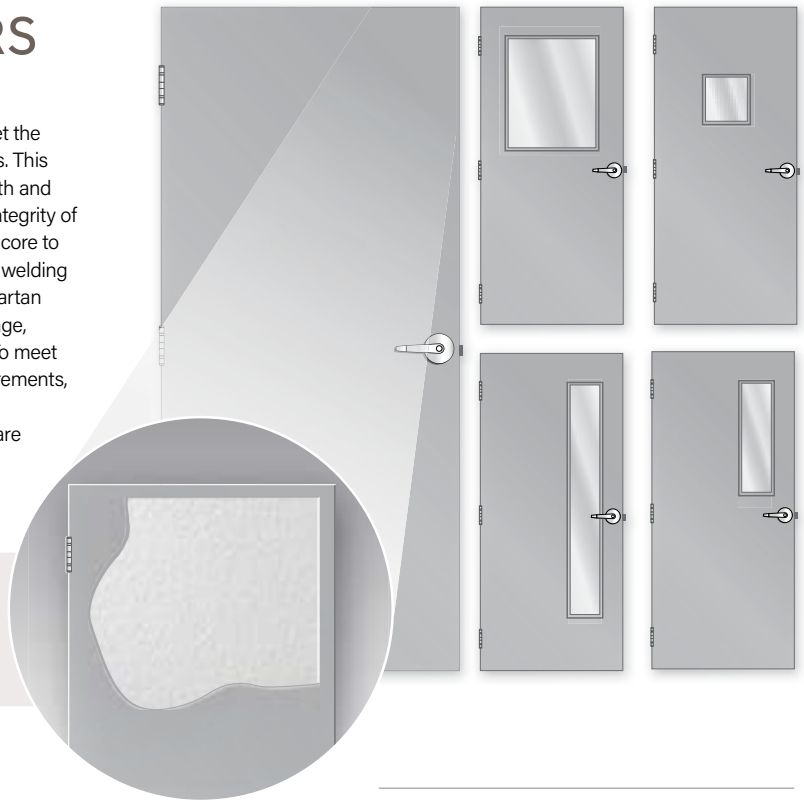

86 LOCK PREP
Optional with face prep

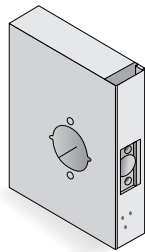

161L LOCK PREP

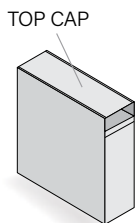

DOOR HEAD

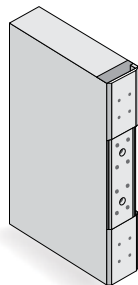

HINGE PREP



Our Spartan Doors and Frames line is proudly Made in Houston with US and global components.



TELL Manufacturing follows the same set of performance specifications as other door manufacturers, as set forth in the Steel Door Institute (SDI) requirements. And UL listed

GENERAL NOTES

1. Edge construction:

- Vertical edges (both hinge and lock) are square with a visible seam.
- Top and bottom edges are closed with inverted 18 - gage welded channels. Exterior applications require the addition of snap-in top caps to protect against the weather.

2. Cores available in the Spartan Door construction:

- Polystyrene, standard, for exterior applications in cold weather conditions.
- Polyurethane option, for exterior applications in extreme weather conditions.

3. Standard hardware preparations—standard mortised and reinforced for:

- Universal Hinge Preps- 4-1/2"(114mm) patented preparation which allows easy and quick field conversion from standard to heavy weight hinges.
- Locks- A multitude of standard lock preps are available. The most commonly used with a 4-7/8" (124mm) strike are 161, 61L and 86.

SPARTAN HOLLOW METAL DOORS

DOORS AND FRAMES

HOLLOW METAL

Spartan Doors and Frames are manufactured from high quality galvanized steel and are thoroughly cleaned inside and out to insure excellent corrosion resistance and paint adhesion. They come standard with a prime coat, ready to be finished.

Our Spartan Door is available in 18 and 16 gauge steel and the Spartan Frame is 16 gauge standard.



DOOR FEATURES

- Door** • 18 and 16 gauge Galvanized Steel
- Paint**
 - Prime painted standard
 - Other paint colors available
 - Custom colors are available, contact customer service
- Hinge Prep**
 - Non-handed 4-1/2" – 7 gauge hinge reinforcements, accommodates heavyweight hinges
- Fire Rated**
 - Up to 3 hours are certified by Underwriters Laboratories
- Channels**
 - 16 gauge inverted top and bottom channel
- Insulation**
 - Polystyrene core standard
 - Polyurethane option available
- Top Cap**
 - Installed steel cap standard
- Closer Prep**
 - 14 gauge reinforced steel, standard

The Spartan Frames are knock-down construction and are designed to be installed on standard and non-standard wall sizes over pre-finished or unfinished drywall.

FRAME FEATURES

- Frame**
 - 16 Gauge Galvanized Steel
 - Knockdown construction
 - Precision Mitered Corners
 - Easy Installation
- Paint**
 - Prime painted standard
- Closer Prep**
 - 14 gauge reinforced steel, standard
- Fire Rated**
 - Up to 3 hours are certified by Underwriters Laboratories
- Closer Prep**
 - 14 gauge reinforced steel, standard

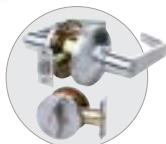
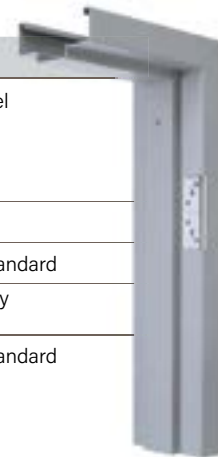

LOCKSET & DEADBOLT READY



CLOSER REINFORCEMENT



TAMPER RESISTANT HINGE



POLYSTYRENE INSULATED CORE



INVERTED TOP AND BOTTOM CHANNEL

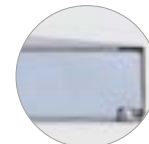

STEEL CAP TOP STANDARD

DRYWALL FRAMES

STANDARD FEATURES

All Spartan Drywall Frames come with adjustable compression anchors in each jamb. These anchors provide a tight rigid fit in the opening.

- 16 gauge for 1 3/4" doors
- Precision fitted corners
- Galvannealed (standard)
- 7 gauge hinge reinforcements
- Heavy duty strike reinforcements
- Universal 4 1/2" hinge prep
- Fire rated up to 1 1/2 hours.
Available on frame openings up to 8'-0" high and 3'-8" wide single door, 7'-4" double door.
- Meets ANSI standards

TYPICAL BASE AND WALL ANCHORS

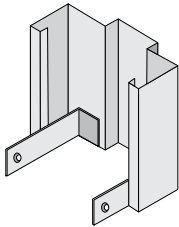

STRAP ANCHOR

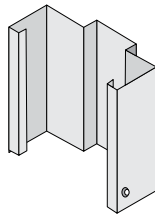

DIMPLE ANCHOR

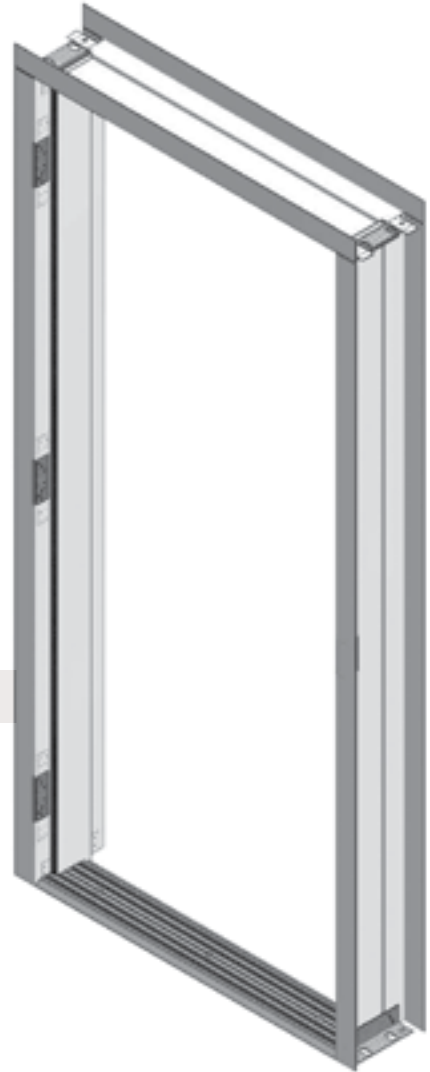

MASONRY FRAMES

STANDARD FEATURES

All Spartan Masonry Frames come with 1/2" returns. Masonry, Wood, and Existing Opening Anchoring (E.O.A.) systems are all available.

- 16 gauge for 1 3/4" doors
- Precision fitted corners
- Galvannealed (standard)
- 7 gauge hinge reinforcements
- Heavy duty strike reinforcements
- Fire rated up to 3 hours.
- Universal 4 1/2" hinge prep
- Meets ANSI standards

TYPICAL BASE AND WALL ANCHORS

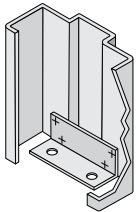

ONE PIECE WELDED BASED ANCHOR

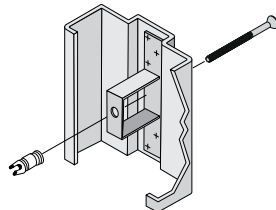

MASONRY WIRE ANCHOR

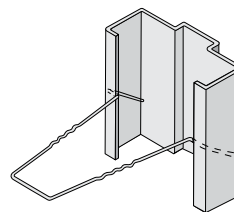

EXISTING OPENING ANCHOR (E.O.A.)

DOOR DIMENSIONS

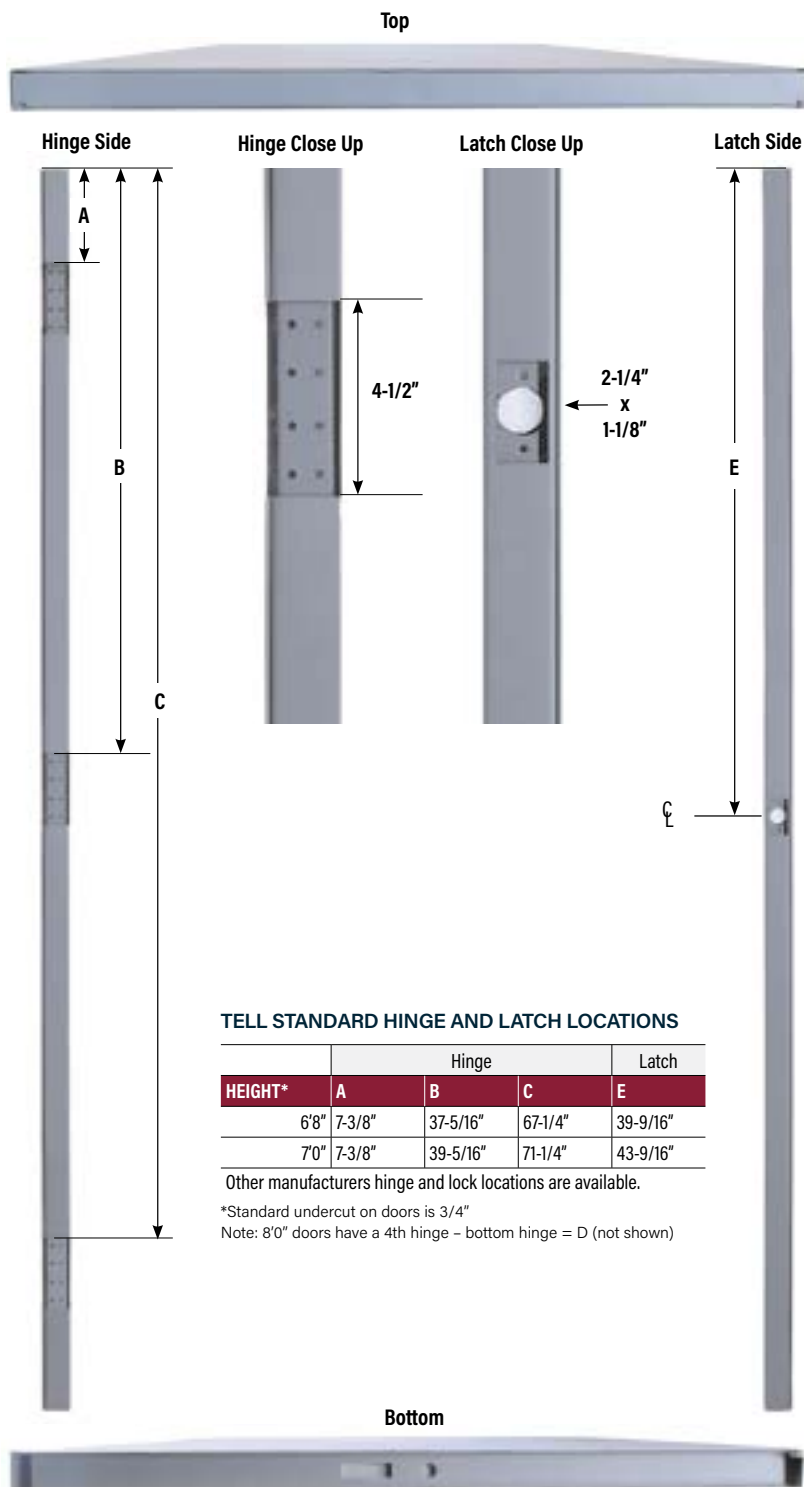

TELL STANDARD HINGE AND LATCH LOCATIONS

HEIGHT*	Hinge			Latch
	A	B	C	E
6'8"	7-3/8"	37-5/16"	67-1/4"	39-9/16"
7'0"	7-3/8"	39-5/16"	71-1/4"	43-9/16"

Other manufacturers hinge and lock locations are available.

*Standard undercut on doors is 3/4"

Note: 8'0" doors have a 4th hinge - bottom hinge = D (not shown)

DETAILS

- Insulated with polystyrene core
- Non-handed
- Galvannealed (standard)
- Fire rated up to 3 hours
- 7 gauge hinge reinforcements
- Reinforced 161 lock prep
- Closer reinforcement (standard)
- Meets ANSI standards
- Universal 4 1/2" hinge prep
- Inverted top and bottom channel
- Installed steel cap standard
- Available with polyurethane core

PAINT OPTIONS



NOTE: Actual colors may vary from those shown due to limitations of the printing production process.

ABBREVIATION LEGEND

ABBREVIATION	EXTENDED DESCRIPTION
1 PNL	1 PANEL
2 PNL	2 PANEL
3 PNL	3 PANEL
4 PNL	4 PANEL
5 PNL	5 PANEL
6 PNL	6 PANEL
3LT	3 LITE
5LT	5 LITE
9LT	9 LITE
12LT	12 LITE
15LT	15 LITE
3/4V	3/4 VIEW
ADA	AMERICANS WITH DISABILITIES ACT
ADJ	ADJUSTABLE
ADJ OI	ADJUSTABLE OPEN IN
BV	BEVELED
EM	EXTERNAL MUNTIN
FBG	FIBERGLASS
FJ	FINGER-JOINT
FLT	FLAT
FV	FULLVIEW
HV	HALF VIEW
HZ	HORIZONTAL
IM	INTERNAL MUNTIN
LT	LITE
LVR	LOUVER
MINI	MINI-BLIND
MTL	METAL
OI	OPEN IN
OO	OPEN OUT
PNL	PANEL
RND	ROUND
SDL	SIMULATED DIVIDED LITE
SL	SIDELIGHT
SQ	SQUARE
V-GRV	V-GROOVE



MM040626DC