



MILLWORK CATALOG

WINDOWS

2026 EDITION



TABLE OF CONTENTS

PELLA®

PELLA®	
STEADY SET™	6
RESERVE™	
WOOD & ALUMINUM CLAD WOOD FAMILIES	8
TRADITIONAL - WOOD & ALUMINUM CLAD WOOD ...	10
CONTEMPORARY - ALUMINUM-CLAD WOOD ...	12
FEATURES & OPTIONS	14
LIFESTYLE SERIES	
ALUMINUM-CLAD WOOD WINDOWS	18
FEATURES & OPTIONS	20
IMPERVIA®	
FIBERGLASS WINDOWS	24
FEATURES & OPTIONS	26
250 SERIES	
VINYL WINDOWS	30
ENCOMPASS	
VINYL WINDOWS	32
250 SERIES & ENCOMPASS	
FEATURES & OPTIONS	34
PELLA®	
WINDOW & PATIO DOOR LINES	38
WINDOW & DOOR TRIM OPTIONS	40

MI® WINDOWS AND DOORS

V2000 VINYL MODELS 1255 + 3500	44
V2000 VINYL MODEL 3540	46
V2000 VINYL MODEL 1555	48
V3000 VINYL MODEL 1620	50
V3000 VINYL MODEL 1556	52
V3000 VINYL MODELS 1675 + 9770	54
V3000 VINYL GARDEN WINDOW	56
V3000 VINYL MODEL 1650	58
BLINDS-BETWEEN-THE-GLASS	60

PGT® WINDOWS

IMPACT VINYL WINDOW	64
IMPACT SINGLE HUNG WINDOW	65
IMPACT DOUBLE HUNG WINDOW	66
IMPACT CASEMENT WINDOW	67
IMPACT HORIZONTAL ROLLER WINDOW	68
IMPACT AWNING WINDOW	69
IMPACT PICTURE WINDOW	70
IMPACT ARCHITECTURAL WINDOW	71
WINDOW OPTIONS	72

ABI WINDOWS

SERIES 500	76
SERIES 700	77

ATRIUM®

5700 VINYL SERIES	80
5700 VINYL SLIDER	81
150 VINYL SERIES	82
450 VINYL SERIES	83
750 VINYL SERIES	84
VINYL ARCHITECTURAL SHAPES	85
SIMULATED DIVIDED LITE	89
BRONZE LAMINATE	90
BLACK PAINT	91

KRESTMARK®

200-275 VINYL SERIES	94
250 VINYL SERIES	96
400 VINYL SERIES	100
220 VINYL REPLACEMENT	102

PLYGEM®

4800 THERMAL BREAK ALUMINUM	106
-----------------------------------	-----

BURRIS WINDOWS

BURRIS WINDOWS	
TECTVIEW EX VINYL	110
TECTVIEW AC VINYL	111
TECTVIEW CA VINYL	112

WINDOR SYSTEMS

2750 FOLDING WINDOW	114
---------------------------	-----

SIMONTON® WINDOWS AND DOORS

PREMIUM VINYL COASTAL WINDOWS	118
PREMIUM VINYL SUNROOM WINDOWS	122

VELUX®

SKYLIGHT SYSTEM	126
DECK-MOUNTED SKYLIGHT SYSTEM	128
CURB-MOUNTED SKYLIGHT SYSTEM	130
FLAT ROOF SKYLIGHT	132
SELF-FLASHED SKYLIGHT	134
SOLAR SKYLIGHTS & MANUAL ROOF SHADES ...	136
SKYLIGHTS & SHADES REMOTE	138
ROOF WINDOW	140
SUN TUNNEL SKYLIGHT	142
ARCHITECTURAL SKYLIGHT	144
INSTALLATION	146







The Future of Window Installation is Here

Meet the **Pella® Steady Set™** Interior Installation System, the **industry's fastest, most labor efficient** wood window installation system with **uncompromising quality**.¹ The award-winning system is a safer way to install and is **3.15 times faster** and **utilizes less labor** than standard fin installation methods.^{2,3} Plus, it is available at no additional cost.

Available on select new construction Pella Reserve™ and Pella Lifestyle Series windows.

¹ Comparing average install time and plumb/level/square measurements of leading national wood window brands when installed following the manufacturer's standard installation methods for new construction windows.

² Compared to the average of the leading national wood window brands installation methods for new construction windows when installing standard size window (29x59) into 2nd story application.

³ Compared to leading national wood window brands recommended installation methods for new construction windows.



STEADY SET™ INSTALLATION SYSTEM

Pella® Steady Set™ Interior Installation System

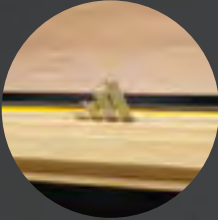

Head Stabilizer

- Engages with the header of the rough opening to help temporarily stabilize the unit
- Helps eliminate the need for someone to hold the unit from falling inwards prior to fastening
- Frees up a secondary installer to move on to other work

Flashing Fin with Continuous Corners

- Pop-up yellow exterior fin is easily deployed after the window is set and helps ensure an exterior water barrier after being flashed
- Features a flexible hinge that naturally adapts to variation within the wall and an integrated corner seal allowing for a continuous seal

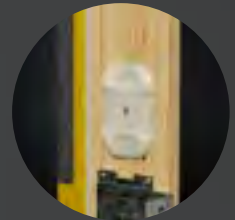
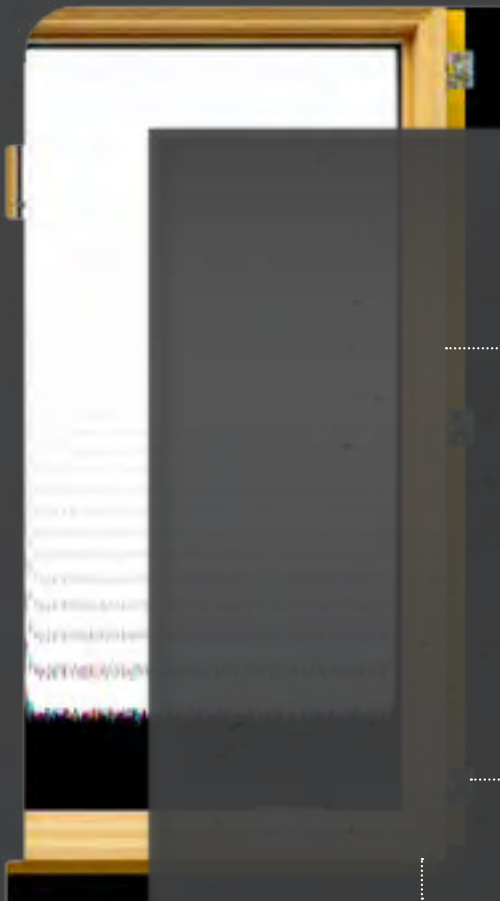

Shim Guide

- Pre-attached to the jambs of select units
- Assists the installer by helping to hold shims in the correct location
- Can help ensure consistent frame to sash reveals

Flip and Click Installation Bracket

- Comes pre-attached to the unit and helps enable a reliable, safe and simple install
- Simply needs to be unclipped, flipped and clicked to be install ready
- This structural attachment method securely attaches the window to the rough opening

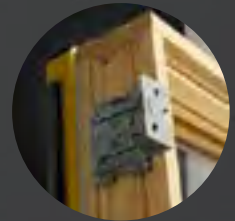

Sill Shim

- Pre-applied sill shims raise the unit 1/4" off the rough opening sill, ensuring space for foam and/or sealant
- Gap allows for installers to easily insert tools to manipulate the unit
- Limits pinched fingers and product damage when leveling

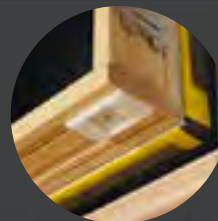



Authentic designs with uncompromised attention to detail.

Made for the distinction creators, the purists of design, the architectural historians — each window and door is meticulously designed to achieve your vision. We deliver tailor-made solutions and intentional innovations to achieve your unique vision without concessions. From simple yet sophisticated style to historical detailing, anything less simply won't do.



Pella Reserve — Traditional

Pella Reserve — Traditional windows and patio doors are exquisitely designed with unparalleled historical detailing. They feature through-stile construction, deliberate proportions and intricate profiles to achieve authentic traditional style.



PELLA® RESERVE™

WOOD & ALUMINUM CLAD WOOD FAMILIES



Contemporary-designed Pella Reserve windows and patio doors offer simple and sophisticated styles with expansive glass, sleek, minimal profiles and through-stile construction, which embody the tenets of pure contemporary design.



Unparalleled historical detailing

Featuring historic elements with uncompromised attention to detail, including Integral Light Technology® grilles and a historic putty profile.

Authentic hardware

With a historically authentic spoon-lock and our Antiek casement window hardware inspired by period furniture.

Integrated Rolscreen®

A retractable screen that appears when you open the window and disappears into the frame when the window is closed.



Exquisitely designed windows and doors with unparalleled historical detailing. Featuring through-stile construction, deliberate proportions and intricate profiles to achieve authentic traditional style. Durable interiors and extruded aluminum exteriors allow you to create the ideal look for your design. And with cutting-edge innovations that solve modern-day inconveniences without compromising the design, your clients can be proud to own Pella Reserve – Traditional windows and patio doors. We know your reputation matters, so we stand behind Pella Reserve products with the best limited lifetime warranty for wood windows and patio doors.*

Achieve your vision and impress your clients. From preliminary drawings to installation, Pella's expert team of architects, engineers, drafters and consultants can work to deliver custom window and door solutions for your project. Partner with Pella to achieve your unique vision without concessions. And with large multi-slide and bifold patio doors, you can create a space that blurs the lines between indoors and out.

* Based on comparing written limited warranties of leading national wood window and wood patio door brands. See Pella written Limited Warranty for details, including exceptions and limitations, at pella.com/warranty or contact Pella Customer Service at 877-473-5527.



Historic elements

Putty profile. Further your aesthetic with the putty profile, recreated with historically accurate angles to provide meaningful depth and a realistic shadow. These products offer the industry's deepest sash dimension.

Through-stile construction. Essential to the tradition of window making, butt joinery and through-stile construction create authentic proportions and emulate historic window design.

Integral Light Technology. Pella's Integral Light Technology helps capture the look of true-divided-light without sacrificing energy performance.

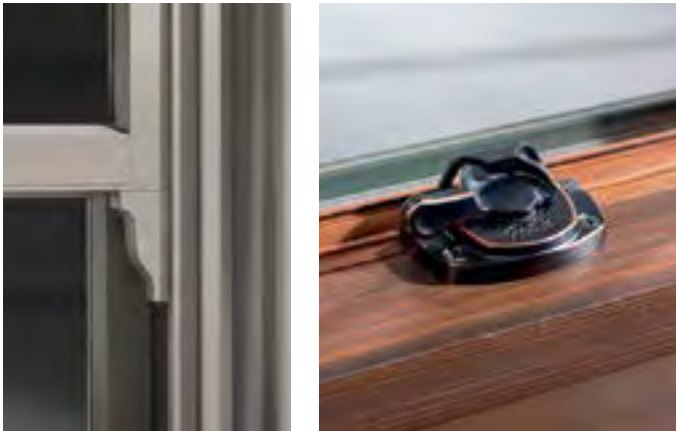

Intentional innovations

Single- and double-hung Integrated Rolscreen.

The Integrated Rolscreen is a screen on a single- and double-hung window that appears when you open the window, and rolls away, out of sight, when you close it.

Innovative sash lugs. Add sash lugs to the exterior of our double-hung windows to create an authentic look, while maintaining modern tilting functionality for easy cleaning.

Integrated security sensors. Preserve the beauty of Pella Reserve windows and doors while protecting what matters most.

Available in these window and patio door styles:

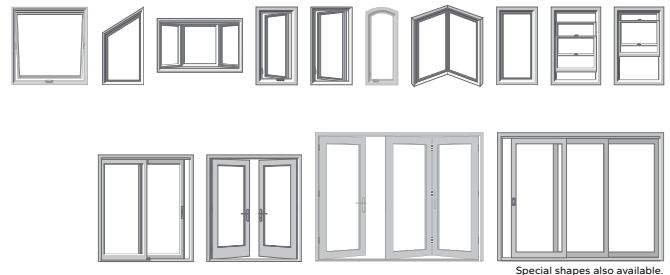

Special shapes also available.



Clean lines

Add sleek, clean lines to your project with industry-leading modern designs.

90° exterior profiles

Pella's patented cladding system delivers a clean sash joint with pure, 90-degree exteriors.

Modern hardware

Our renowned, exclusive hardware features sleek lines. The Saldo foldaway crank adds the perfect finishing touch.



Achieve your unique design vision without concessions with simple and sophisticated designs. With expansive glass, sleek, minimal profiles and through-stile construction, this design embodies the tenets of pure contemporary style.

With uncompromised attention to detail, our cutting-edge innovations solve modern-day inconveniences. Add an expansive multi-slide or bifold patio door to your design for a space that blurs the lines between indoors and out. Preserve the beauty of Pella Reserve – Contemporary windows and doors while protecting what matters most with integrated security sensors. Windows and patio doors can be monitored from virtually anywhere with the free Pella Insynctive® App.¹ And we stand behind our products with the best limited lifetime warranty for wood windows and patio doors.²

¹ Requires the Pella Insynctive App on a smart device, an Insynctive Bridge and a wireless home internet router with internet connection.

² Based on comparing written limited warranties of leading national wood window and wood patio door brands. See Pella written Limited Warranty for details, including exceptions and limitations, at pella.com/warranty or contact Pella Customer Service at 877-473-5527.



PELLA® RESERVE™ CONTEMPORARY - ALUMINUM-CLAD WOOD



Clean lines

Expansive glass. Expansive glass combined with some of the narrowest sightlines in the industry allow you to bring your vision to life.

Minimal profiles. Our industry leading modern design delivers sleek, squared-off sash profiles. Square grille profiles provide another layer of design flexibility.

Modern hardware. Our renowned, exclusive hardware has set the bar for the industry. Featuring sleek lines, the Saldo foldaway crank adds the perfect finishing touch.

Achieve your vision

Durable, extruded aluminum. Available in a wide variety of exterior colors or create your own unique exterior color to meet your design needs.

Virtually unlimited customization. From extra tall to extra wide. Custom sizes, grille patterns and designs, finishes, wood types and glass options are available.

Tailor-made solutions. From preliminary drawings to installation, Pella's expert team of architects, engineers, drafters and consultants can work to deliver custom window and door solutions for your project.

Available in these window and patio door styles:



Special shapes also available.



Colors & Finishes

Wood Types

C T

Choose the wood species that best complements your project's interior.

Custom solutions:

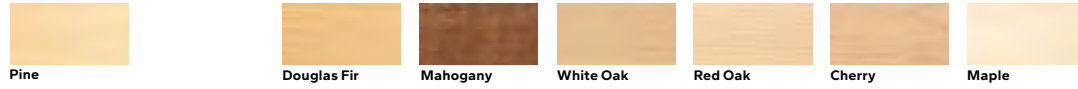

Prefinished Pine Interior Colors

C T

When you select pine, we can prefinish in your choice of a variety of paint and stain colors. Unfinished or primed and ready-to-paint are also available.

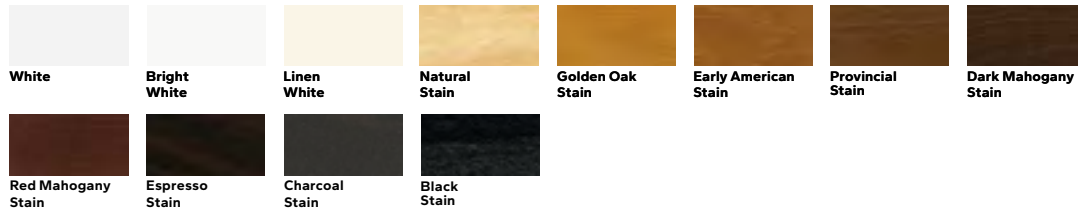

Extruded Aluminum-Clad Exterior Colors

C T

Our low-maintenance EnduraClad® exterior finish resists chalking and fading. Take durability further with EnduraClad Plus protective finish, which meets the industry's highest exterior coating standard to defend against chalking and fading.¹ Custom colors are also available.



Glass

InsulShield® Low-E Glass²

 Advanced Low-E insulating dual-pane glass with argon or triple-pane glass with argon³ C T	 AdvancedComfort Low-E insulating dual-pane glass with argon C T	 NaturalSun Low-E insulating dual-pane glass with argon or triple-pane glass with argon³ C T	 NaturalSun+ Low-E insulating dual-pane glass with argon C T	 SunDefense™ Low-E insulating dual-pane glass with argon or triple-pane glass with argon³ C T	 SunDefense+ Low-E insulating dual-pane glass with argon C T
--	---	--	---	---	---

Additional Glass Options

 Laminated (non-impact-resistant)^{4,5}, tinted^{2,4} or obscure^{2,4} glass also available on select products C T	 STC (Sound Transmission Class)-improved dual-pane sound glass^{5,6} C T	 Impact-resistant glass^{3,4} C T
---	---	--

¹ The highest exterior coating standard for painted aluminum exteriors is the AAMA 2605 standard. EnduraClad Plus protective finish is not available with all colors. See your local Pella sales representative for availability.
² Optional high-altitude InsulShield Low-E glass is available with or without argon on select products.
³ Available on select products only. See your local Pella sales representative for availability.
⁴ Available with Low-E insulating glass with argon on select products.
⁵ For best performance, the laminated glass may be in the interior or exterior pane of the insulating glass, depending on the product.
⁶ Sound control glass consists of dissimilar glass thickness (3mm/5mm).



Grilles

Grille Types

Choose the look of true divided light with Integral Light Technology® or make cleaning easier by selecting grilles-between-the-glass.



Ogee Integral Light Technology®
7/8", 1-1/4" or 2"¹

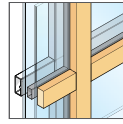

Square Integral Light Technology®
5/8", 7/8", 1-1/4" or 2"¹



Aluminum Grilles-Between-the-Glass
3/4"

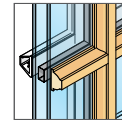

Putty Glaze Integral Light Technology® with Ogee Interior!
5/8", 7/8", 1-1/4" or 2"

Grilles-Between-the-Glass Interior Colors:²



Black



White



Brown



Fossil

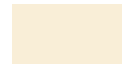

Ivory



Harvest



Cordovan

Grille Patterns

In addition to the patterns shown here, custom grille patterns are available.



12-Lite Prairie



14-Lite Prairie



Victorian



New England



Traditional



9-Lite Prairie



Top Row



Cross



Custom



Diamond



Simulated French



Screens³

Rolscreen® & Integrated Rolscreen



Rolscreen soft-closing retractable screens roll out of sight when not in use on Pella Reserve – Traditional casement windows and sliding patio doors and on Pella Reserve – Contemporary sliding patio doors. The Integrated Rolscreen is a fully concealed Rolscreen that moves seamlessly with the sash – appearing when you open a Pella Reserve – Traditional single- or double-hung window and rolling completely away when you close it.

Flat



InView™ screens let in 14% more light and are 8% more open for improved airflow.⁴

Added Peace of Mind

Integrated Security Sensors



Optional integrated wireless security sensors maintain aesthetics, streamline security installation and ensure no warranty loss is caused by post-installation drilling. Sensors can be monitored via the free Pella® Insynctive® App and are compatible with major security panel systems.⁵ For more information, go to connectpella.com.

¹ Color-matched to your product's interior and exterior color.

² Appearance of exterior grille color may vary depending on the Low-E insulating glass selection.

³ Warning: Use caution when children or pets are around open windows and doors. Screens are not designed to retain children or pets.

⁴ Improved airflow is based on calculated screen cloth openness. Screen cloth transmittance was measured using an integrated sphere spectrophotometer.

⁵ Requires the Insynctive App on a smart device, an Insynctive Bridge and a wireless home router with internet connection.



Window Hardware

Classic Collection

T

Get a timeless look with authentic styles in classic finishes.



Fold-Away Crank
Antiek



Spoon-Style Lock

Finishes:

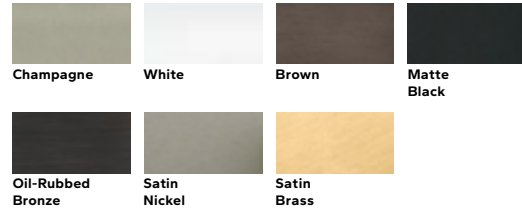

Modern Collection

C

Achieve the ultimate contemporary look with exclusive hardware designed by Pella.



Fold-Away Crank
Saiido

Finishes:

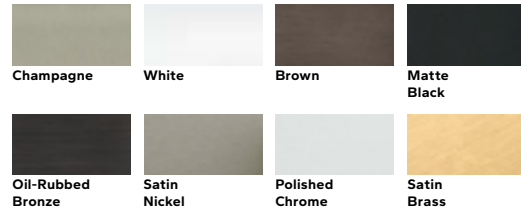

Rustic Collection

T

Create a distinct and charming look with distressed finishes.



Fold-Away Crank
Antiek



Spoon-Style Lock

Finishes:

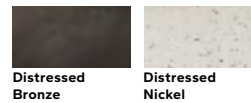

Essential Collection

T

Select from popular designs and finishes to suit every style.



Fold-Away Crank



Cam-Action Lock

Finishes:

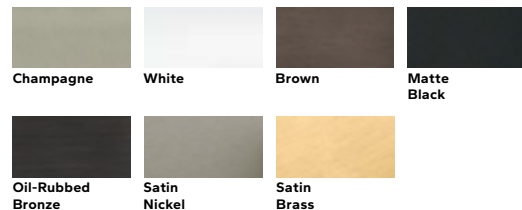



Patio Door Hardware

Classic Collection



BALDWIN

Choose timeless pieces for a look that will never go out of style.



**Hinged & Bifold
Patio Door Handles**
Virago



**Sliding & Multi-
Slide Patio
Door Handle**
Ambrose



**Multi-Slide
Patio Door
Handle**^{1,2}

Finishes:



Matte
Black



Oil-Rubbed
Bronze



Satin
Nickel



Satin
Brass

Modern Collection



BALDWIN

Achieve the ultimate contemporary look with sleek finishes.



**Hinged & Bifold
Patio Door Handle**
Spire



**Sliding & Multi-
Slide Patio
Door Handle**
Plazo



**Multi-Slide
Patio Door
Handle**^{1,2}

Finishes:

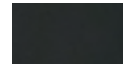

Matte
Black



Satin
Nickel

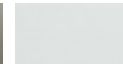

Polished
Chrome



Satin
Brass

Rustic Collection



BALDWIN

Stand out with bold looks and create an utterly unique aesthetic.



**Hinged & Bifold
Patio Door Handles**
Rustiek



**Sliding & Multi-
Slide Patio
Door Handle**
Notus

Finishes:



Distressed
Bronze

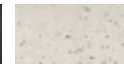

Distressed
Nickel

Essential Collection



Elevate your style and transform a home with elegant selections.



**Hinged & Bifold
Patio Door Handles**
Standard



**Sliding Patio
Door Handle**
Standard



**Multi-Slide
Patio Door
Handle**^{1,2}

Finishes:



Champagne



White



Brown

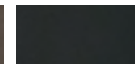

Matte
Black



Oil-Rubbed
Bronze

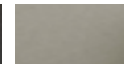

Satin
Nickel



Satin
Brass

¹ Flush multi-slide handle is a Pella exclusive design.
² Flush multi-slide handle is not available in Champagne.

PELLA® LIFESTYLE SERIES

ALUMINUM-CLAD WOOD WINDOWS



#1 performing wood window and patio door¹

For the combination of energy, sound and value.

37 time-tested innovations

Create unique, room-by-room solutions to meet real-life needs.

83% more energy efficient²

On average compared to single-pane windows — with performance solutions for improved comfort.



Create solutions that are perfect for real life. Covered by the best limited lifetime warranty in the industry for wood windows and patio doors, Pella Lifestyle Series offers everything you love about wood — including beauty, durability and style flexibility.³ Begin with dual- or triple-pane glass and then select from the most desired features and options.⁴

Pella Lifestyle Series is the #1 performing wood window and patio door for the combination of energy, sound and value.¹ Packed with purposeful innovations like the Hidden Screen and integrated blinds, shades and security sensors, we designed windows and patio doors to work for your project, room by room.



PELLA® LIFESTYLE SERIES ALUMINUM-CLAD WOOD WINDOWS



Exceptional performance and style.

Style flexibility. Whether your client's home is traditional, modern or somewhere in between, choose beautiful windows and patio doors that fit their style.

Redefining performance. Get both unrivaled energy efficiency and sound performance at an incredible value. With the Ultimate Performance package, windows are on average 79% more energy efficient and reduce 52% more outside noise than single-pane windows.^{2,5}

Enhanced durability. Our windows are designed to stand the test of time with exterior wood parts treated with exclusive EnduraGuard® wood protection and an aluminum-clad exterior with EnduraClad® finish.

Room-by-room solutions.

Hidden Screen. The innovative double-hung screen appears when the window is open and folds away when it is closed. It is easy to install and retrofittable.

Integrated blinds and shades. Intentionally designed to be accessible, blinds and shades are tucked between glass panes and are protected from dust, pets and little hands.

Added security and convenience. Add peace of mind with optional built-in window and door sensors and motorized between-the-glass blinds and shades that raise and lower with a touch of a button.

¹ Performance solutions require upgrades to triple-pane, AdvancedComfort Low-E and mixed glass thickness. Based on comparing product quotes and published STC/OITC and U-Factor ratings of leading national wood window and patio door brands.

² Window energy efficiency calculated in a computer simulation using RESFEN 6.0 default parameters for a 2000 sq. foot new construction single-story home when comparing Pella Lifestyle Series windows with Advanced Comfort Low-E triple-pane glass with argon and mixed glass thickness to a single-pane wood or vinyl window. Double-hung windows are not available with triple-pane glass. The energy efficiency and actual savings will vary by location. The average window energy efficiency is based on a national average of 94 modeled cities across the country and weighting based on population. For more details see pella.com/methodology.

³ Based on comparing written limited warranties of leading national wood window and wood patio door brands. See Pella written Limited Warranty for details, including exceptions and limitations, at pella.com/warranty, or contact Pella Customer Service at 866-319-0397.

⁴ Double-hung window only available with dual-pane glass.

⁵ Reduction in sound based on OITC ratings of Pella Lifestyle Series windows with triple-pane glass with mixed glass thickness to a single-pane wood or vinyl window with an OITC of 19. Calculated by using the sound transmission loss values in the 80 to 4000 Hz range as measured in accordance with ASTM E-90(09). Actual results may vary.

Available in these window and patio door styles:



Special shapes also available.



FEATURES & OPTIONS

Colors & Finishes

Wood Type

A beautiful wood species to complement a home's interior.



Pine

Prefinished Pine Interior Colors

We can prefinish in your choice of a variety of beautiful paints and stains. Unfinished or primed and ready-to-paint are also available.

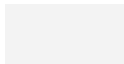

White

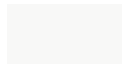

Bright White

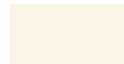

Linen White



Golden Oak Stain



Early American Stain



Provincial Stain



Black Stain

Aluminum-Clad Exterior Colors

Our low-maintenance EnduraClad® exterior finish resists fading and helps protect windows and patio doors for years.



Black

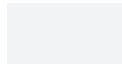

White



Brown



Fossil



Iron Ore



Portobello



Putty



Almond

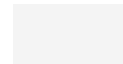

Classic White



Brick Red



Hartford Green



Wolf Gray

Glass¹

InsulShield® Low-E Glass²



Advanced Low-E insulating dual-pane glass with argon or triple-pane glass with argon



Advanced Comfort Low-E insulating dual-pane glass with argon and triple-pane glass with argon



NaturalSun Low-E insulating dual-pane glass with argon or triple-pane glass with argon



NaturalSun+ Low-E insulating dual-or triple-pane glass with argon



SunDefense® Low-E insulating dual-pane glass with argon or triple-pane glass with argon



SunDefense+ Low-E insulating dual-or triple-pane glass with argon

Additional Glass Options



Tempered glass available on dual- and triple-pane products



Obscure and frosted glass available on dual- and triple-pane products

¹ Double-hung window available with dual-pane glass only.

² Optional high-altitude Low-E insulating glass does not contain argon in most products. Please see your local Pella sales representative for more information.



PELLA® LIFESTYLE SERIES

FEATURES & OPTIONS

Performance Packages

To make things easier, we've created performance packages that highlight what's most important to your customers.

Performance solutions offer an unbeatable combination of energy efficiency, sound control and value.¹ Upgrade from a dual- to a triple-pane glass design with the packages below to meet the unique needs of each room in your customer's home.

All values below are averages compared with single-pane windows.



Performance

Improved energy efficiency and sound performance.

71% + **34%**
More Energy Efficient² Noise Reduction³



Sound Control

Exceptional noise control for a quieter home.

52%
Noise Reduction³



Energy Efficiency

Superior energy efficiency for a more comfortable home.

83%
More Energy Efficient²



Ultimate Performance

The best combination of energy efficiency and noise control.

79% + **52%**
More Energy Efficient² Noise Reduction³



Scan the QR code with your smartphone camera to learn more about how each performance package can benefit your client's home.

¹ Performance solutions require upgrades to triple-pane, AdvancedComfort Low-E and mixed glazing thickness glass. Based on comparing product quotes and published STC/OITC and U-Factor ratings of leading national wood window and patio door brands.

² Window energy efficiency calculated in a computer simulation using RESFEN 6.0 default parameters for a 2000 sq. foot new construction single-story home when Pella Lifestyle Series windows with the respective performance package are compared to a single-pane wood or vinyl window. The energy efficiency and actual savings will vary by location. The average window energy efficiency is based on a national average of 94 modeled cities across the country and weighting based on population. For more details see pella.com/methodology.

³ Reduction in sound based on OITC ratings of Pella Lifestyle Series windows with respective performance package compared to a single-pane wood or vinyl window with an OITC of 19. Calculated by using the sound transmission loss values in the 80 to 4000 Hz range as measured in accordance with ASTM E-90(09). Actual results may vary.



Grilles

Grille Types

Choose the look of true divided light, or make cleaning easier by selecting grilles-between-the-glass.

Dual-Pane:



Simulated-Divided-Light with Spacer 7/8"¹



Simulated-Divided-Light without Spacer 7/8"¹



Aluminum Grilles-Between-the-Glass 3/4"²

Triple-Pane:



Aluminum Grilles-Between-The-Glass 3/4"²

Grille Patterns

In addition to the patterns shown here, custom grille patterns are available.



9-Lite Prairie

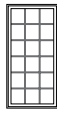

Traditional

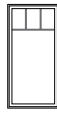

Top Row

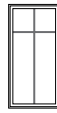

Cross



Custom

Screens³

Rolscreen®

Rolscreen soft-closing retractable screens roll out of sight when not in use. Available on casement windows and sliding patio doors.

Hidden Screen

The exclusive, easy-to-use Hidden Screen appears when you open a double-hung window and folds away when the window is closed. It allows 44% more natural light into your home when a window is closed than a standard screen.⁴

Flat

InView[™] screens are clearer than conventional screens and come standard.



InView[™]

Added Peace of Mind

Integrated Security Sensors

Optional integrated wireless security sensors maintain aesthetics, streamline security installation and ensure no warranty loss is caused by post-installation drilling. Sensors can be monitored via the free Pella® Insynctive® App and are compatible with major security panel systems.⁵ For more information, go to connectpella.com.

¹ Color-matched to your product's interior and exterior color.

² Appearance of exterior grille color may vary depending on the Low-E insulating glass selection.

³ Warning: Use caution when children or pets are around open windows and doors. Screens are not designed to retain children or pets.

⁴ Based on calculated screen cloth openness.

⁵ Requires the Insynctive App on a smart device, an Insynctive Bridge and a wireless home router with internet connection.



PELLA® LIFESTYLE SERIES

FEATURES & OPTIONS

Integrated Blinds & Shades

Integrated Blinds*

Raise blinds up for an unobstructed view or tilt to let in the right amount of light. Our accessible, integrated blinds are available with or without motorization powered by Pella Insynctive® technology.

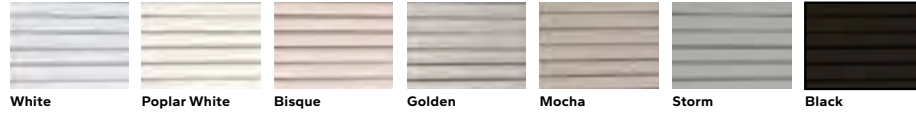

Integrated Shades*

Our best integrated fabric shades feature a white exterior fabric for a uniform look from the street. Our accessible, integrated shades are available with or without motorization powered by Pella Insynctive® technology.

Light-Filtering:



Room-Darkening:



Haven't landed on the final blind or shade color yet? No problem.

With our patented triple-pane design, your customers can make the decision later in the process. Our triple-pane products come with all of the hardware to add blinds or shades before they arrive to the home or later in the building or remodeling process.



Scan the QR code with your smartphone camera to learn more about our motorized Insynctive blinds and shades.

Window Hardware

Essential Collection

Our most popular designs with finishes to suit every style.



Fold-Away Crank



Cam-Action Lock

Finishes:

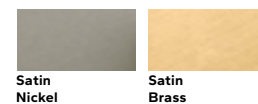
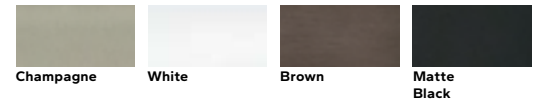

Patio Door Hardware

Essential Collection

Elevate your style and transform a home with elegant selections.



Hinged Patio Door Handle



Sliding Patio Door Handle

Finishes:

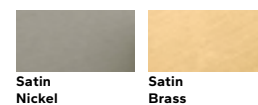
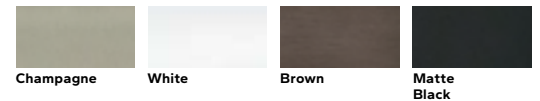

* Available on triple-pane products only.



Unmatched strength & lasting durability

Made from our proprietary fiberglass, the strongest material available for windows and patio doors.¹

Sleek, timeless style

Versatile design elements combined with sleek profiles and clean lines deliver a timeless style.

Proven performance

Get outstanding resistance to water, wind and outside noises while increasing energy efficiency, security and ease of operation.



Pella Impervia products are engineered to last. Our proprietary fiberglass material provides unmatched strength and lasting durability with sleek, timeless style.² And they balance thermal efficiency, scale and value when it matters most.

Don't leave water and structural performance to chance. Tested in extremes and designed for every day, Pella Impervia products are engineered for the rigorous performance requirements of a commercial building and are designed to resist water, wind and outside noises.³ With nearly 100 years in business, it's rare to come across an application that we haven't already designed a robust installation for. We've got you covered with both products and an installation designed for your exact situation. And whether new construction or window replacement, we have a dedicated team of experts to help with your project.



PELLA® IMPERVIA® FIBERGLASS WINDOWS

Installation solutions & expertise

Save time and reduce costly callbacks with our exclusive installation methods. It's rare to come across an application that we haven't already solved for.

Tested beyond requirements

Tested to extremes from -40°F to 180°F, our proprietary fiberglass can handle the most extreme heat and sub-cold.² Our products are tested beyond industry standards to help ensure less maintenance with fewer callbacks.



Rigorously tested, optimized designs.

100x more impact resistant than Fibrex.⁴ Pella Impervia products are made from our proprietary fiberglass material and are on average 100x more impact-resistant than Andersen Fibrex, a wood/plastic composite product. You can trust our fiberglass products to stand up to a hammer misfire and other jobsite conditions.

Tested beyond requirements. Tested to extremes from -40°F to 180°F, our proprietary fiberglass can handle the most extreme heat and sub-cold.² Our products are tested beyond industry standards to help ensure less maintenance with fewer callbacks.

ENERGY STAR® certified.⁵ Pella Impervia products offer energy-efficient options that will meet or exceed ENERGY STAR guidelines in all 50 states.

Sleek, versatile elements.

Up-to-date color palette. Interior and exterior color options to achieve your customer's unique design style, including Black. Our colors are a durable, powder-coat finish which resists chalking and fading.

Revolutionary hardware. Our patented Easy-Slide Operator allows your homeowner to simply slide to open casement and awning windows, without the effort of cranking. Select a complementary or contrasting hardware finish to add interest.

Unique factory mulling. Factory-mulled combinations help save you time on the jobsite. And the superior strength of Pella fiberglass allows you to create larger, unique combinations, made just for your remodel or new construction project.

Available in these window and patio door styles:



Special shapes also available.

¹ Pella's proprietary fiberglass material has displayed superior strength over wood, vinyl, aluminum, wood/plastic composites, and other fiberglass materials used by leading national brands in tensile and 3-point bend tests performed in accordance with ASTM D638 and D790 testing standards.

² In testing performed in accordance with ASTM testing standards, Pella's fiberglass has displayed superior performance in strength, ability to withstand extreme heat and cold and resistance to dents and scratches. Special shape windows are made from a fiberglass resin material.

³ Pella Impervia windows and patio doors have a performance grade of LC or higher. For information on product ratings see pella.com/performance.

⁴ Impact testing performance based on testing 10 samples of each material using ASTM D256, Method C.

⁵ Pella products may not meet ENERGY STAR guidelines in Canada. For more information, contact your local Pella sales representative or go to energystar.gc.ca.



FEATURES & OPTIONS

Colors & Finishes

Frame Colors

Our long-lasting powder-coat finish resists chalking and fading so you never need to paint or refinish.

Solid-Color Frame:

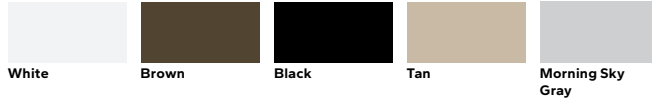

Dual-Color Frame:¹



Glass & Additional Energy Efficiency Upgrades

InsulShield® Low-E Glass²



Advanced Low-E insulating dual- or triple-pane glass with argon



AdvancedComfort Low-E dual-pane glass with argon



NaturalSun Low-E insulating dual- or triple-pane glass with argon



NaturalSun+ Low-E insulating dual-pane glass with argon



SunDefense Low-E insulating dual- or triple-pane glass with argon



SunDefense+ Low-E insulating dual-pane glass with argon

Additional Glass Options



Bronze-tinted Advanced Low-E insulating glass with argon²



Obscure Low-E insulating glass



Tempered glass



Laminated (non-impact-resistant)³ or tinted⁴



STC (Sound Transmission Class) dual-pane sound control glass⁵



Triple-pane glass⁶



Impact-resistant glass

Foam Insulation Options

Optional foam-insulated frames are available to increase energy efficiency.





Grilles

Grilles

Grilles are color-matched to the window or patio door interior and exterior frame color.



Aluminum Grilles-
Between-the-
Glass 3/4"

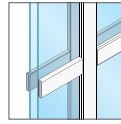

Applied
Grilles®

Grille Patterns

Choose from one of our standard grille patterns, or create a unique look with custom grille patterns.⁹



Traditional



6-Lite Prairie



9-Lite Prairie



Top Row

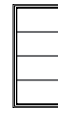

Custom

Screens®

Flat Screen

InView™ screens let in 14% more light and are 8% more open for improved airflow when compared to the conventional fiberglass screen.¹¹



InView™

¹ Dual-color frames are available with a block frame or non-integrated nailing fin.

² Optional high-altitude Low-E insulating glass available with or without argon on select products.

³ For best performance, the laminated glass may be in the interior or exterior pane of the insulating glass, depending on the product.

⁴ Available with Advanced Low-E insulating glass with argon with bronze, gray or green tint on selected products.

⁵ Sound control glass consists of dissimilar glass thickness (3mm/5mm or 5mm/3mm).

⁶ Available on direct set, awning, casement windows and sliding patio doors.

⁷ Appearance of exterior grille color may vary depending on the Low-E insulating glass selection.

⁸ Available on direct set windows only.

⁹ Grille patterns offered may vary per product. See specific product information for availability.

¹⁰ Warning: Screen will not stop child or pet from falling out of window or door. Keep child or pet away from open window or door.

¹¹ Improved airflow is based on calculated screen cloth openness. Screen cloth transmittance was measured using an integrated sphere spectrophotometer.



FEATURES & OPTIONS

Window Hardware

Casement & Awning

The patented Easy-Slide Operator is a revolutionary way to operate casement and awning windows. Simply slide to open, without the effort of cranking. With precision venting technology, the window will open to an exact location. Or select the fold-away crank, which folds neatly away against the window frame. Both solutions allow roomside window treatments to hang neatly.



Easy-Slide Operator



Fold-Away Crank

Color-Matched Finishes:

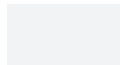

White



Brown



Matte Black



Tan



Morning Sky Gray

Additional Finish:



Satin Nickel

Sliding, Single- & Double-Hung

Pella's cam-action lock pulls the sash against the weatherstripping on single-hung, double-hung and sliding windows for a tighter seal.



Cam-Action Lock

Color-Matched Finishes:

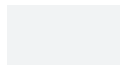

White



Brown



Matte Black



Tan



Morning Sky Gray

Additional Finishes:



Satin Nickel



Bright Brass



Oil-Rubbed Bronze



Patio Door Hardware

Sliding Patio Door

A multipoint lock is available in color-matched and upgraded finishes to complement your project.



Sliding Patio Door Handle

Color-Matched Finishes:

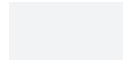

White



Brown

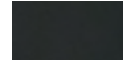

Matte Black



Tan



Morning Sky Gray

Additional Finish:



Satin Nickel

Secure Vent Lock

A secure vent lock comes standard on all Pella Impervia sliding doors and provides security in both the closed and venting positions.



Secure Vent Lock

Color-Matched Finishes:

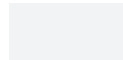

White



Brown

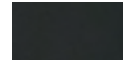

Matte Black



Tan



Morning Sky Gray

Patio Door Blinds*

Blinds-Between-the-Glass

Add privacy and complement a home's decor with blinds-between-the-glass. Located between panes of glass, blinds are protected from dust, dirt and damage.



White



Slate Gray



Espresso

* Available on select sizes only. Contact your local Pella representative for more information.

PELLA® 250 SERIES

VINYL WINDOWS



Innovative security and privacy features

Optional security and privacy features on windows and patio doors give your customers more peace of mind.

52% stronger frames¹

Multi-chambered vinyl frames and reinforced sashes are stronger than ordinary vinyl for increased durability.

62% more energy efficient²

Windows with triple-pane glass create a more comfortable home than windows with single-pane glass.



Pella 250 Series products offer innovative and enhanced security and privacy features for more peace of mind. Our exclusive vinyl formula is performance tested for excellent weathering, durability and color retention. Insulating frame chambers improve energy efficiency and multi-chambered frame designs are 52% stronger than ordinary vinyl.¹

With innovative and enhanced security and privacy features and our durable and low-maintenance, easy-care vinyl, Pella 250 Series windows and patio doors are a great complement to your project.

¹ Based on the force required to bend a window frame profile.

² Window energy efficiency calculated in a computer simulation using RESFEN 5.0 default parameters for a 2000 sq. foot existing single-story home when comparing a Pella 250 Series vinyl window with InsulShield Advanced Low-E triple pane glass with argon to a single paned wood or vinyl window. The range of energy efficiency will vary from 54% to 77% and will vary by location. Your actual savings will vary. The average window energy efficiency is based on a national average of 94 modeled cities across the country with an adjustment based on population. For more details see pella.com/methodology.

³ To achieve a Grade 40 rating on ASTM F842, a test for forced entry excluding glass breakage, the optional footbolt must be installed and engaged.



PELLA® 250 SERIES VINYL WINDOWS



Strong and Secure Vinyl.

Improved security. The classic sliding patio door with integrated footbolt meets or exceeds the highest industry requirements for forced entry and is our most secure vinyl patio door.³

Unique tamper prevention system. Double- and single-hung windows are designed with an interlocking checkrail, steel hardware reinforcement and a unique anti-jar sill.

Strong vinyl material. With multi-chambered frames and optional steel reinforced sashes, these frames are 52% stronger than ordinary vinyl, resist warping and twisting and install easily!

More of Everything You Love.

Excellent energy efficiency. Multiple insulating air chambers deliver comfort for your customers. Upgraded triple-pane windows are on average 62% more energy efficient than single-pane windows.²

Exclusive vinyl formula. Using our exclusive fade-resistant formula, Pella's high-grade vinyl is performance-tested for excellent durability and weathering.

Quality that lasts. To help ensure our products exceed industry requirements and expectations, we test both the entire window and individual parts for strength and durability.

Available in these window and patio door styles:



Special shapes also available.

PELLA® ENCOMPASS

VINYL WINDOWS



Competitively priced

Easy-care, low-maintenance vinyl at a price that is easy on the budget.

Energy-efficient options

Offering solutions to improve comfort and help save on heating and cooling costs.

Backed by Pella

A leader in the window and door industry and a brand that has been trusted for nearly 100 years.



With Encompass by Pella, you can get windows and patio doors backed by the brand you know and trust, at a price that is easy on the budget.

Featuring low-maintenance, high-grade vinyl frames, these windows are energy efficient and look great for years. Lower heating and cooling costs with energy-efficient options that will meet or exceed ENERGY STAR® guidelines in all 50 states.¹

¹ Some Pella products may not meet ENERGY STAR® guidelines in Canada. For more information, contact your local Pella sales representative or go to energystar.gc.ca.

² The Pella Limited Lifetime Warranty is non-prorated, meaning the coverages within the defined warranty periods do not decrease over time. See written limited warranty for details, including exceptions and limitations, at installpella.com/warranties, or contact Pella Customer Service at 866-319-0397.

³ Double-hung window available in East Region only.



PELLA® ENCOMPASS VINYL WINDOWS



Easy-care vinyl.

Low-maintenance. The solid color throughout keeps minor dings and scratches virtually invisible and doesn't require painting.

More comfortable. Pella's weather protection system helps protect a home from leaks and drafts.

Stand the test of time. Our precision welding process makes a strong and more durable product that resists warping and twisting.

Designed to make life easier.

Easy operation. Pella's true glide balance system allows single- and double-hung windows to open and close easily and quietly.

Dust-free grilles and blinds. Never worry about cleaning between-the-glass grilles and blinds. Grilles-between-the-glass are sealed between glass on windows and patio doors and blinds-between-the-glass are sealed between glass on patio doors. This keeps the grilles and blinds safe from dust and damage.

Limited lifetime warranty. Backed by one of the best warranties in the business, you can be confident in your selection.²

Available in these window and patio door styles:³



Special shapes also available.

PELLA® 250 SERIES & ENCOMPASS



FEATURES & OPTIONS

Colors & Finishes

Frame Colors

Create a signature look with solid-color and dual-color frames. Dual-color frames allow your customers to choose a different color for the exterior with a White interior.

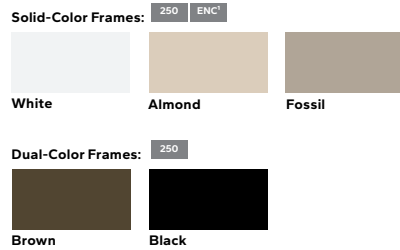

Glass & Additional Energy Efficiency Upgrades

InsulShield® Low-E Glass²

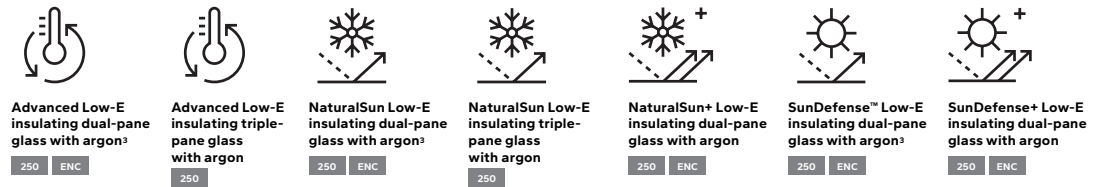

Additional Glass Options



Foam Insulation Options

Optional foam-insulated frames are available to increase energy efficiency. 250 ENC¹

¹ Feature availability varies by location. See local Pella representative for details.

² Optional high-altitude Low-E insulating glass available with or without argon on select products.

³ Not available with blinds-between-the-glass on Encompass by Pella sliding patio doors.



PELLA® 250 SERIES & ENCOMPASS

FEATURES & OPTIONS

Grilles

Grille Types

Grilles are color-matched to the window or patio door interior and exterior frame color.



Grilles-Between-the-Glass Flat 5/8^{1,2,3}

250 ENC



Grilles-Between-the-Glass Contour 3/4^{1,2}

250 ENC

Grille Patterns

Choose from a variety of grille patterns for the traditional look of divided light.⁴

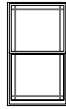

6-Lite Prairie



9-Lite Prairie



9-Lite Prairie
Top Sash Only

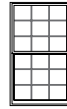

Traditional



Traditional
Top Sash Only



Top Row



Custom
Equally Divided

Screens⁵

Flat Window Screens

InView™ screens are available on all venting vinyl windows and let in 14% more light and are 8% more open for improved airflow when compared to the conventional fiberglass screen.⁶ 250 ENC

Sliding Patio Door Screens

Heavy-duty sliding screens come standard on Pella 250 Series sliding patio doors and are optional on Encompass by Pella sliding patio doors. 250 ENC

¹ Appearance of exterior grille color may vary depending on the Low-E insulating glass selection.

² Grilles are not available with blinds-between-the-glass on Encompass by Pella sliding patio doors.

³ Available on Encompass by Pella products in West region only.

⁴ Grille patterns offered may vary by product. See specific product information for availability.

⁵ Warning: Use caution when children or pets are around open windows and doors. Screens are not designed to retain children or pets.

⁶ Improved airflow is based on calculated screen cloth openness. Screen cloth transmittance was measured using an integrated sphere spectrophotometer.

PELLA® 250 SERIES & ENCOMPASS



FEATURES & OPTIONS

Window Hardware

Casement and Awning

Folds neatly out of the way so it won't interfere with roomside window treatments. Finishes complement frame colors.



Fold-Away Crank
250

Color-Matched Finishes: 250



Sliding, Single- and Double-Hung

Pella's cam-action locks push the sashes against the weatherstripping for a tighter seal. Optional AutoLock hardware automatically locks the window when it is shut, simply close the sash and confirm it latches.



Cam-Action Lock
250



Cam-Action Lock
ENC

Color-Matched Finishes: 250 ENC



AutoLock
250

Integrated Sash Lift

Make raising and lowering single- and double-hung window sashes easy with a standard, integrated sash lift.



Window Integrated Sash Lift
250 ENC

Color-Matched Finishes: 250 ENC



Window Limited Opening Devices

A vent stop can be engaged or disengaged manually and restricts how far the bottom sash of a double-hung window can open. A window opening control device (WOCD) complies with a safety standard and allows for ventilation, emergency escape and rescue when released. A WOCD automatically limits the sash opening to less than four inches, unless it is intentionally disengaged, enabling the sash to fully open.



Vent Stop
250 ENC



WOCD
250 ENC

Color-Matched Finishes: 250 ENC





PELLA® 250 SERIES & ENCOMPASS

FEATURES & OPTIONS

Patio Door Hardware

Sliding Patio Door Handle

Match the door's exterior color with a color-matched handle or coordinate it with other finishes in a home.



Sliding Patio Door Handle
Standard Multipoint Locking System
250

Sliding Patio Door Handle
ENC

Color-Matched Finishes: 250 ENC



White

Almond

Fossil

Additional Interior Finishes: 250 ENC



Oil-Rubbed Bronze

Satin Nickel

Integrated Flush Footbolt

Pella 250 Series classic sliding patio door with integrated flush footbolt is our most secure vinyl patio door.¹ The patent-pending footbolt is flush with the frame, providing secondary venting and locking abilities without compromising beauty.



250

Color-Matched Finishes: 250



White

Almond

Fossil

Patio Door Blinds

Blinds-Between-the-Glass^{2,3}

Add privacy and complement your project's decor with blinds-between-the-glass. Located between panes of glass, blinds are protected from dust, pets and damage.

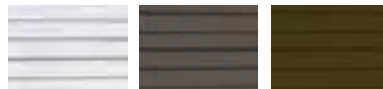

White
250 ENC⁴

Slate Gray
250

Espresso
250

¹ To achieve a Grade 40 rating on ASTM F842, a test for forced entry excluding glass breakage, the optional footbolt must be installed and engaged.



² Availability varies by size. See a Pella professional for details.

³ Available on dual-pane products only. Not available on sliding patio doors with grilles-between-the-glass.

⁴ Only available on 60" x 80" and 72" x 80" doors.



Review our lines and discover your best fit.

			
Product Line	Pella® Reserve™		Pella® Lifestyle Series
	Traditional	Contemporary	
Material	Clad-Wood	Clad-Wood	Clad-Wood
Price	\$\$\$\$\$	\$\$\$\$\$	\$\$\$-\$\$\$\$
Description	Exquisitely designed windows and doors with unparalleled historical detailing. Featuring through-stile construction, deliberate proportions and intricate profiles to achieve authentic traditional style.	Simple and sophisticated designs with expansive glass, sleek, minimal profiles and through-stile construction embody the tenets of pure contemporary style.	Designed to deliver exceptional performance and create room-by-room solutions with time-tested innovations including the Hidden Screen and integrated blinds, shades and security sensors. Available performance solutions offer an unbeatable combination of energy efficiency, sound control and value. ²
Available Styles	<p>Window Styles</p> <p>A AT B C CO DH F</p> <p>SH PC</p> <p>Patio Door Styles</p> <p>SD HD BF MS</p>	<p>Window Styles</p> <p>A AT C CO F</p> <p>Patio Door Styles</p> <p>SD HD BF MS</p>	<p>Window Styles</p> <p>A B C DH¹ F</p> <p>Patio Door Styles</p> <p>SD HD</p>

Window & Patio Door Styles¹

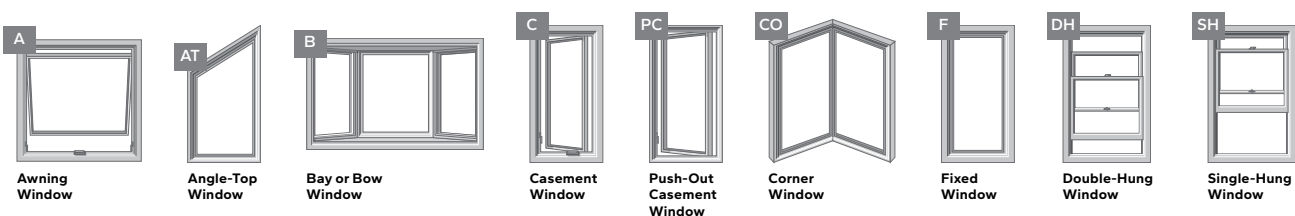



WINDOW & PATIO DOOR LINES

For more information on Pella's window and patio door offering, see your local Pella sales representative or visit pellaprodealer.com.

<p>Pella Impervia®</p>	<p>Pella 250 Series</p>	<p>Encompass by Pella</p>
<p>Fiberglass</p> <p>\$\$\$-\$\$\$\$</p> <p>Pella Impervia products are engineered to last. Our proprietary fiberglass material provides unmatched strength and lasting durability with sleek, timeless style.⁴ Tested in extremes and designed for every day, these windows and patio doors deliver proven performance.</p>	<p>Vinyl</p> <p>\$\$-\$\$\$\$</p> <p>Pella 250 Series products offer innovative and enhanced security and privacy features for more peace of mind. Made with beautiful easy-care vinyl, these windows and patio doors provide Pella craftsmanship in a great-looking product.</p>	<p>Vinyl</p> <p>\$</p> <p>Encompass by Pella is competitively priced, easy-care vinyl. Featuring low-maintenance, high-grade vinyl frames, these windows and patio doors will look great for years and are backed by a brand you can trust.</p>
<p>Window Styles</p> <p>A AT B C DH F SH SW</p> <p>Patio Door Styles</p> <p>SD</p>	<p>Window Styles</p> <p>A AT B C DH F SH SW</p> <p>Patio Door Styles</p> <p>SD</p>	<p>Window Styles</p> <p>AT DH² F SH SW</p> <p>Patio Door Styles</p> <p>SD</p>



Sliding Window

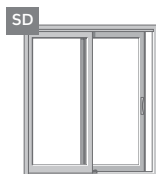

Sliding Patio Door



Hinged Patio Door

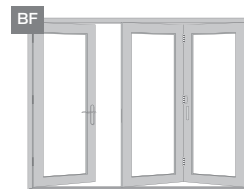

Bifold Patio Door

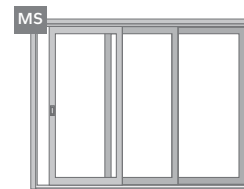

Multi-Slide Patio Door

¹ Additional special shapes also available.
² Performance solutions require upgrades to triple-pane, AdvancedComfort Low-E and mixed glass thickness. Based on comparing product quotes and published STC/OTC and U-Factor ratings of leading national wood window and patio door brands.
³ Double-hung window only available with dual-pane glass.
⁴ Pella's proprietary fiberglass material has displayed superior strength over wood, vinyl, aluminum, wood/plastic composites, and other fiberglass materials used by leading national brands in tensile and 3-point bend tests performed in accordance with ASTM D638 and D790 testing standards.
⁵ Double-hung window available in East Region only.

WINDOW & DOOR TRIM OPTIONS

Interior Wood Trim

Dramatically reduce installation time with factory-applied and factory-finished trim. Pella's beautiful trim options provide a vast range of choices that are true to your customer's home architectural style and décor.

The trim around Pella® wood, fiberglass or vinyl windows and doors can coordinate with other trim on your project, including baseboards, crown molding and chair rails. Optional accessories to coordinate with trim profiles are available.

Wood Types

Choose the wood species that best complements your project's interior.



Pine Oak

Prefinished Pine Interior Colors

Trim is available prefinished in your choice of a variety of paints and stains. Unfinished and ready-to-paint are also available.

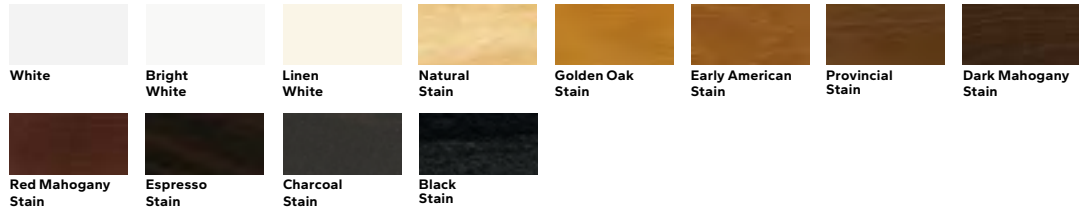

White Bright White Linen White Natural Stain Golden Oak Stain Early American Stain Provincial Stain Dark Mahogany Stain
 Red Mahogany Stain Espresso Stain Charcoal Stain Black Stain

Interior Trim Styles*

Choose from several styles of prefinished or unfinished wood interior trim to fit your project including these popular styles. Select trim styles available in Oak.



Craftsman Ranch Colonial Curved



WINDOW & DOOR TRIM OPTIONS

**EnduraClad®
Exterior Trim**

Add distinctive architectural detail to your project and set off the Pella wood windows and patio doors with style. Our low-maintenance, aluminum-clad exterior trim arrives factory-applied on windows and patio doors to save installation time and costs.

**Exterior Finish
Colors**

Our low-maintenance, aluminum EnduraClad® exterior finish resists chalking and fading. Custom colors are also available.



**Exterior Trim
Styles**

EnduraClad exterior aluminum trim is available in five standard profiles. Or choose a custom design.



**Installation
Methods**

Pella makes installing windows and doors easy. Multiple installation methods and exclusive features save time and help reduce costly callbacks.

For complete installation instructions and videos, visit installpella.com.



**MI[®] WINDOWS
and DOORS**



V2000 Series Single-hung window

MODELS 1255 & 3500

Boasting a stylish look, these single-hung windows are favorites among builders and contractors for new home construction and replacement projects. The removable meeting rail, sash, and top-glass allow for easy drywall pass-through while multiple color options, stylish beveled profile, full-length lift rail, and metal reinforcements at the meeting rail provide homeowners with aesthetic options and desirable performance.



What you can expect

ENERGY-EFFICIENCY

Our dual-pane insulated glass helps save on heating and cooling costs while enhancing home comfort.

- In cool weather, it provides outstanding thermal performance to eliminate cold spots near windows.
- In warm weather, insulated glass reduces solar heat gain and minimizes interior glare.

CONVENIENCE AND STYLE

- Beveled exterior profile creates a clean, timeless aesthetic
- Surface-mounted, forced-entry-resistant locks provide a stronger, safer seal
- Full-length lift rail for easy opening and closing
- Tilt-in bottom sash for easy cleaning
- Optional window operating control device for enhanced safety

Engineered to perform

- Welded, multi-chamber frame and sash
- Available frame styles: fin, finless
- Heavy-duty weatherstripping
- 2 7/8" frame depth
- Available with brickmould accessory and integral J-channel*
- Wood extension jambs available for 4 9/16" and 6 9/16" wall depths

Min and max sizing

WIDTH		HEIGHT	
MIN	MAX	MIN	MAX
13"	48"	24"	96"
CONTINUOUS HEAD & SILL (CHS) MAX			
Twin (Each Window)	47 1/2"	83 1/2"	
Twin (Overall Unit)	95 1/8"	83 1/2"	
Triple (Each Window)	35 3/4"	83 1/2"	
Triple (Overall Unit)	107 1/2"	83 1/2"	

Available in 1/4" increments. DP upgrade required for any unit greater than 84" tall. CHS available on XX, XO, OX, XXX, and XOX configurations.

Energy efficient glass

Optional tempered glass adds additional strength and obscure or rain glass allows light in while protecting privacy.

GLAZING TYPE	U-VALUE	SHGC	STC
Low-E glass	0.33	0.28	28
Low-E glass with grids	0.33	0.26	28
Argon and Low-E glass	0.29	0.28	28
Argon and Low-E glass with grids	0.29	0.26	28
HP Low-E glass	0.33	0.21	28
HP Low-E glass with grids	0.33	0.19	28
Argon and HP Low-E glass	0.29	0.21	28
Argon and HP Low-E glass with grids	0.29	0.19	28
Argon and Low-E Triple Pane glass	0.22	0.24	n/a
Argon, Low-E Triple Pane glass, and grids	0.22	0.21	n/a

Note: all values based on standard 3/4" dual-pane insulated glass unit unless noted otherwise



**V2000 SERIES
SINGLE HUNG WINDOW**
See additional product and warranty information online.



Create a customized look

Enhance your home's spaces with a variety finish options and grid configurations.

FINISH OPTIONS

EXTERIOR	INTERIOR
White EXTRUSION	White EXTRUSION
Almond PAINT / EXTRUSION	Almond EXTRUSION
Clay PAINT / EXTRUSION †	Clay EXTRUSION †
Cocoa PAINT †	Black LAMINATE ‡
Cream PAINT †	
Forest Green PAINT †	
Bronze LAMINATE † / PAINT †	
Black Matte LAMINATE † / PAINT †	

GRID TYPES



Grids-Between-the-Glass Flat

Grids-Between-the-Glass Sculptured

Simulated Divided Lite

*J-Channel available on 3500 model only.
† Clay interior available on products manufactured in Texas only; may only be combined with clay extruded exterior.
‡ Exterior laminate available with white interior only; has a satin finish (matte applies to black paint only).
◊ Exterior paint not available with brickmould.
§ Black laminate interior available on black laminate exterior only.

MI[®] Build boldly by choosing a range of MI window and door styles with expansive views, contemporary framing and hardware.

miwindows.com/windows/V2000/single-hung

V2000 VINYL MODEL 3540



V2000 Series Single-hung window

MODEL 3540

Boasting a stylish look, the 3540 single-hung window is specifically designed to meet high design pressure (DP) requirements for new home construction and remodeling and replacement projects. The removable meeting rail, sash, and top-glass allow for easy drywall pass-through while multiple color options, stylish beveled profile, full-length lift rail, and metal reinforcements at the meeting rail provide homeowners with aesthetic options and desirable performance.



What you can expect

ENERGY-EFFICIENCY

Our dual-pane insulated glass helps save on heating and cooling costs while enhancing home comfort.

- In cool weather, it provides outstanding thermal performance to eliminate cold spots near windows
- In warm weather, insulated glass reduces solar heat gain and minimizes interior glare

CONVENIENCE AND STYLE

- Beveled exterior profile creates a clean, timeless aesthetic
- Surface-mounted tilt latches and forced-entry-resistant locks provide a stronger, safer seal
- Full-length lift rail for easy opening and closing
- Tilt-in bottom sash for easy cleaning
- Optional window operating control device for enhanced safety

Engineered to perform

- Welded, multi-chamber frame and sash
- Heavy-duty weatherstripping
- Available frame styles: mounting fin, flange, finless
- 2 7/8" frame depth
- Available with brickmould accessory and integral J-channel
- Wood extension jambs available for 4 9/16" and 6 9/16" wall depths
- Optional configuration for fixed glass removal allowing for efficient drywall pass through during construction

Min and max sizing

WIDTH		HEIGHT	
MIN	MAX	MIN	MAX
13"	48"	24"	96"
48"	52"	24"	84"
CONTINUOUS HEAD & SILL (CHS) MAX			
Twin (Each Window)	47 3/4"	84"	
Twin (Overall Unit)	95 5/8"	84"	
Triple (Each Window)	36"	84"	
Triple (Overall Unit)	108 1/4"	84"	

Available in 1/4" increments. DP upgrade required for any unit greater than 84" tall. CHS available on XX, XO, OX, XXX, and XOX configurations.

Energy efficient glass

Optional tempered glass adds additional strength and obscure or rain glass allows light in while protecting privacy.

GLAZING TYPE	U-VALUE	SHGC	STC
Low-E glass	0.33	0.28	27
Low-E glass with grids	0.33	0.26	27
Argon and Low-E glass	0.30	0.28	27
Argon and Low-E glass with grids	0.30	0.26	27
HP Low-E glass	0.33	0.21	27
HP Low-E glass with grids	0.33	0.19	27
Argon and HP Low-E glass	0.30	0.21	27
Argon and HP Low-E glass with grids	0.30	0.19	27
Argon and LoE ³ -340 glass	0.30	0.15	27
Argon and LoE ³ -340 glass with grids	0.30	0.13	27
Argon and Low-E Triple Pane glass	0.22	0.24	n/a
Argon, Low-E Triple Pane glass, and grids	0.22	0.21	n/a

Note: All values based on standard 3/4" dual-pane insulated glass unit unless noted otherwise.



**V2000 SERIES
SINGLE-HUNG WINDOW**
See additional product and warranty information online.



Create a customized look

Enhance your home's spaces with a variety of finish options and grid configurations.

FINISH OPTIONS

EXTERIOR	INTERIOR
White EXTRUSION	White EXTRUSION
Almond PAINT / EXTRUSION	Almond EXTRUSION
Clay PAINT / EXTRUSION †	Clay EXTRUSION †
Cocoa PAINT †	Black LAMINATE ‡
Cream PAINT †	
Forest Green PAINT †	
Bronze LAMINATE † / PAINT †	
Black Matte LAMINATE † / PAINT †	

GRID TYPES



Grids-Between-the-Glass Flat Sculptured Simulated Divided Lite

- † Clay interior available on products manufactured in Texas only; may only be combined with clay extruded exterior.
- ‡ Exterior laminate available with white interior only; has a satin finish (matte applies to black paint only).
- †† Exterior paint not available with brickmould.
- § Black laminate interior available on black laminate exterior only.

MI[®] Build boldly by choosing a range of MI window and door styles with expansive views, contemporary framing and hardware.

miwindows.com/windows/V2000/single-hung



What you can expect

ENERGY EFFICIENCY

Our dual-pane insulated glass helps save on heating and cooling costs while enhancing home comfort.

- In cool weather, it provides outstanding thermal performance to eliminate cold spots near windows.
- In warm weather, insulated glass reduces solar heat gain and minimizes interior glare.

CONVENIENCE AND STYLE

- Beveled exterior profile creates a clean, timeless aesthetic
- Dual-opposing, mortised recessed locks create a stronger, safer seal
- Tilt-in top and bottom sash for easy cleaning
- Push-button vent stops enable ventilation without sacrificing safety and security
- Inverted-coil balances with detent clip provide smooth operation and prevent sash from drifting

By MITER Brands™

V2000 SERIES / MODEL 1555

Engineered to perform

- Welded, multi-chamber frame and sash
- Interlocking sash with heavy-duty weatherstripping
- Metal-reinforced meeting rail
- True-sloping sill
- 3 ¼" frame depth
- Available frame styles: finless, mounting fin
- Wood extension jambs available for 4 ⅞" and 6 ⅞" wall depths

Min and max sizing

WIDTH		HEIGHT	
MIN	MAX	MIN	MAX
15"	17"	28"	84"
17 ¼"	52"	23 ½"	60"

CONTINUOUS HEAD & SILL (CHS) MAX	
Twin (Each Window)	37 ¾"
Twin (Overall Unit)	75 ¾"
Triple (Each Window)	37 ¾"
Triple (Overall Unit)	113 ½"

Available in 1/8" increments. CHS available on XX and XXX configurations. 1555 Picture Window is not available with CHS.

Energy efficient glass

Optional tempered glass adds additional strength and obscure or rain glass allows light in while protecting privacy.

GLAZING TYPE	U-VALUE	SHGC
Argon and Low-E glass	0.28	0.26
Argon and Low-E glass with grids	0.28	0.23
Argon and Low-E DSB glass	0.28	0.26
Argon and Low-E DSB glass with grids	0.28	0.23
Argon and HP Low-E glass	0.29	0.21
Argon and HP Low-E glass with grids	0.29	0.19
Argon and HP Low-E DSB glass	0.28	0.21
Argon and HP Low-E DSB glass with grids	0.28	0.19

Note: all values based on standard 3/4" dual-pane insulated glass unit unless notes otherwise



V2000 SERIES DOUBLE-HUNG WINDOW
See additional product and warranty information online.



Create a customized look

Enhance your home's spaces with a variety of finish options and grid configurations.

FINISH OPTIONS

EXTERIOR	INTERIOR
White EXTRUSION	White EXTRUSION
Almond EXTRUSION	Almond EXTRUSION

GRID TYPES

	
Flat Grids-Between-the-Glass	Sculptured Grids-Between-the-Glass

MI[®] Build boldly by choosing a range of MI window and door styles with expansive views, contemporary framing and hardware.

miwindows.com/windows/V2000/double-hung

V3000 VINYL MODEL 1620

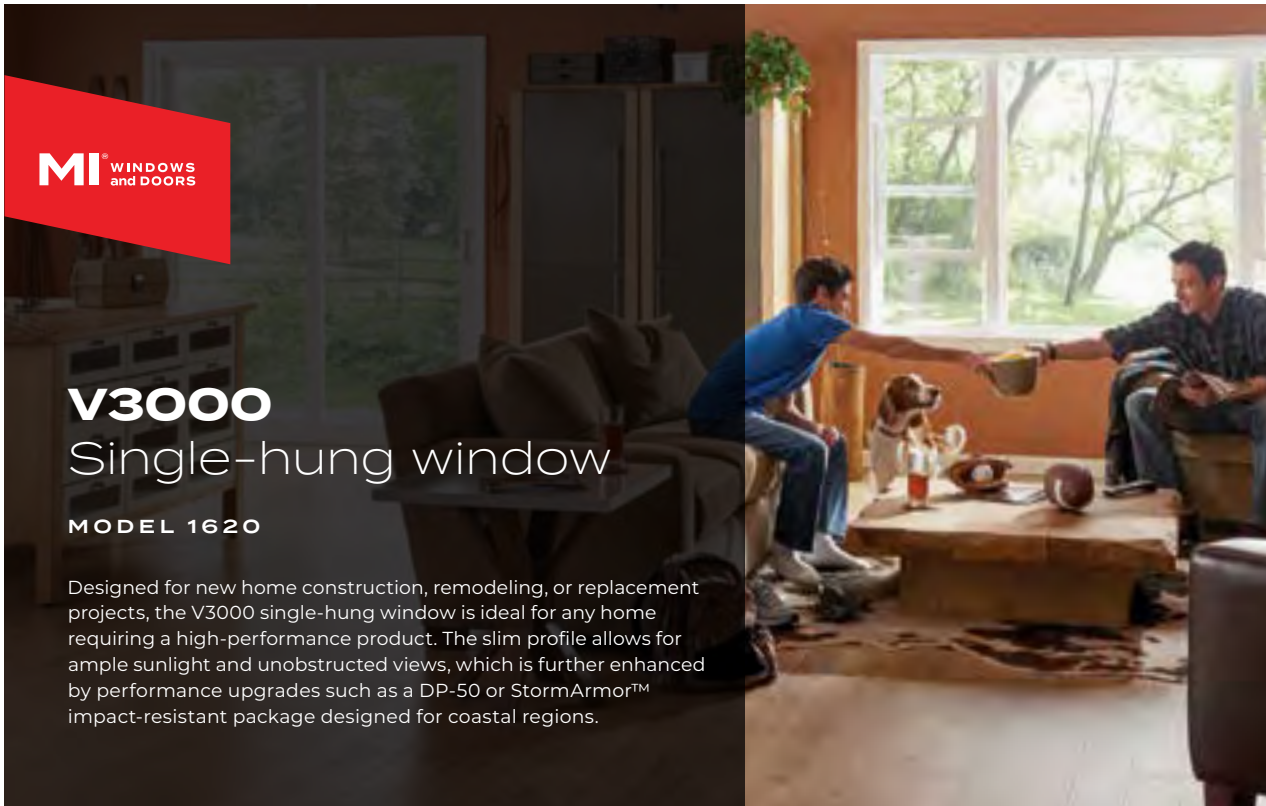

MI®
WINDOWS
and DOORS

V3000 Single-hung window

MODEL 1620

Designed for new home construction, remodeling, or replacement projects, the V3000 single-hung window is ideal for any home requiring a high-performance product. The slim profile allows for ample sunlight and unobstructed views, which is further enhanced by performance upgrades such as a DP-50 or StormArmor™ impact-resistant package designed for coastal regions.



What you can expect

ENERGY EFFICIENCY

Our dual-pane insulated glass helps save on heating and cooling costs while enhancing home comfort.

- In cool weather, it provides outstanding thermal performance to eliminate cold spots near windows.
- In warm weather, insulated glass reduces solar heat gain and minimizes interior glare.

CONVENIENCE AND STYLE

- Brickmould exterior profile offers a timeless appeal
- Dual-opposing, mortised recessed locks create a stronger, safer seal
- Integral lift rail for easy opening and closing
- Tilt-in bottom sash for easy cleaning
- Inverted-coil balances provide smooth operation
- Push-button vent stops enable ventilation without sacrificing safety and security
- Optional window operating control device for enhanced safety

Engineered to perform

- Welded, multi-chamber frame and sash
- 3 3/4" frame depth
- Heavy-duty weatherstripping
- Available frame styles: mounting fin, flange, finless
- Optional StormArmor™ package includes impact-resistant glass with argon, Cardinal LoE³-366, and preserve film to protect the glass until installation is complete
- Optional DP-50 package



Min and max sizing

WIDTH		HEIGHT	
MIN	MAX	MIN	MAX
15"	48"	24 1/2"	96"
48 1/8"	52 1/8"	24 1/2"	74"
WITH STORMARMOR			
23"	52 1/8"	24 1/2"	75"

Available in 1/8" increments.

Energy efficient glass

Optional tempered glass adds additional strength and obscure or rain glass allows light in while protecting privacy.

GLAZING TYPE	U-VALUE	SHGC	STC
Argon and Low-E glass	0.29	0.30	29
Argon and Low-E glass with grids	0.29	0.27	29
Argon and HP Low-E glass	0.29	0.22	29
Argon and HP Low-E glass with grids	0.29	0.20	29
Impact-resistant laminated glass with argon and LoE ³ -366	0.29	0.22	32
Impact-resistant laminated glass with argon and LoE ³ -366 with grids	0.29	0.20	32
Impact-resistant laminated glass with argon and LoE ³ -340	0.29	0.14	32
Impact-resistant laminated glass with argon and LoE ³ -340 with grids	0.29	0.13	32

Note: all values based on standard 3/4" dual-pane or 7/8" impact-resistant insulated glass unit unless noted otherwise

Create a customized look

Enhance your home's spaces with a variety of finish options and grid configurations.

FINISH OPTIONS

EXTERIOR	INTERIOR
White EXTRUSION	White EXTRUSION
Almond EXTRUSION	Almond EXTRUSION
Clay EXTRUSION	Clay EXTRUSION
Bronze LAMINATE ‡	
Black LAMINATE ‡	

‡ Exterior laminate available with white interior only

GRID TYPES



V3000 SINGLE-HUNG
See additional product and warranty information online.



MI[®] Build boldly by choosing a range of MI window and door styles with expansive views, contemporary framing and hardware.

miwindows.com/V3000



V3000 Series Double-hung window

MODEL 1556

Our top-selling double-hung window for new home construction, this V3000 Series double-hung window features superior styling, handcrafted quality, and exceptional long-term performance. Its stylish beveled exterior profile and eight exterior color options are complemented by energy-efficient options such as a warm-edge spacer system and insulated dual- or triple-pane glass.



What you can expect

ENERGY EFFICIENCY

Our dual- and triple-pane insulated glass package options help save on heating and cooling costs while enhancing home comfort.

- In cool weather, it provides outstanding thermal performance to eliminate cold spots near windows.
- In warm weather, insulated glass reduces solar heat gain and minimizes interior glare.

CONVENIENCE AND STYLE

- Beveled exterior profile creates a timeless aesthetic
- Dual-opposing, mortised recessed locks create a stronger, safer seal
- Full FlexScreen™ with Clarity Screen™ mesh allows for optimal ventilation without compromising visibility
- True-sloping sill optimizes water drainage and eliminates unsightly weep holes
- Tilt-in top and bottom sash for easy cleaning
- Push-button vent stops enable ventilation without sacrificing safety and security
- Inverted-coil balances with detent clip provide smooth operation and prevent sash from drifting

By MITER Brands™

V3000 SERIES / MODEL 1556

Engineered to perform

- Welded, multi-chamber frame and sash
- Interlocking sash
- Metal-reinforced meeting rail
- Available frame styles: mounting fin, finless
- 3 ¼" frame depth
- Wood extension jambs available for 4 ½" and 6 ½" wall depths
- Optional field-applied drywall returns, exterior brickmould, and factory-applied 3 ½" flat casing

Min and max sizing

WIDTH		HEIGHT	
MIN	MAX	MIN	MAX
15"	48"	28"	80"
48 ½"	52 ½"	24 ½"	60"

CONTINUOUS HEAD & SILL (CHS) MAX	
Twin (Each Window)	47 ¾"
Twin (Overall Unit)	95 ⅝"
Triple (Each Window)	37 ¾"
Triple (Overall Unit)	113 ½"

Available in 1/8" increments. CHS available on XX and XXX configurations.

Energy efficient glass

Optional tempered glass adds additional strength and obscure or rain glass allows light in while protecting privacy.

GLAZING TYPE	U-VALUE	SHGC	STC
Low-E glass	0.31	0.26	28
Low-E glass with grids	0.31	0.24	28
Argon and Low-E glass	0.28	0.26	28
Argon and Low-E glass with grids	0.28	0.23	28
Argon and Low-E DSB glass	0.28	0.26	30
Argon and Low-E DSB glass with grids	0.28	0.23	30
HP Low-E DSB glass	0.32	0.21	30
HP Low-E DSB glass with grids	0.32	0.19	30
Argon and HP Low-E DSB glass	0.28	0.21	30
Argon and HP Low-E DSB glass with grids	0.28	0.19	30
Argon and Low-E triple-pane glass	0.22	0.22	n/a
Argon and Low-E triple-pane glass with grids	0.23	0.20	n/a

Note: all values based on standard 3/4" dual-pane or 7/8" triple-pane insulated glass unit unless noted otherwise

V3000 SERIES DOUBLE-HUNG WINDOW
 See additional product and warranty information online.



Create a customized look

Enhance your home's spaces with a variety of finish options and grid configurations.

FINISH OPTIONS

EXTERIOR	INTERIOR
White EXTRUSION	White EXTRUSION
Almond PAINT / EXTRUSION	Almond EXTRUSION
Clay PAINT	
Cocoa PAINT	
Cream PAINT	
Forest Green PAINT	
Bronze PAINT	
Black Matte PAINT †	

GRID TYPES

Grids-Between-the-Glass Flat Grids-Between-the-Glass Sculptured Simulated Divided Lite Simulated Meeting Rail

BLINDS-BETWEEN-THE-GLASS[§]

Optional addition to let you control sunlight and privacy without the need for bulky window treatments.

SIX COLOR OPTIONS

- White
- Tan
- Sand
- Espresso
- Slate gray
- Silver moon

† Clay interior available on products manufactured in Texas only; may only be combined with clay extruded exterior; not available with foam or triple-pane glass
 ‡ Woodgrain interior not available with black or clay exterior
 § Blinds-between-the-glass available for dual-pane glass only

MI[®] Build boldly by choosing a range of MI window and door styles with expansive views, contemporary framing and hardware.

miwindows.com/windows/V3000/double-hung

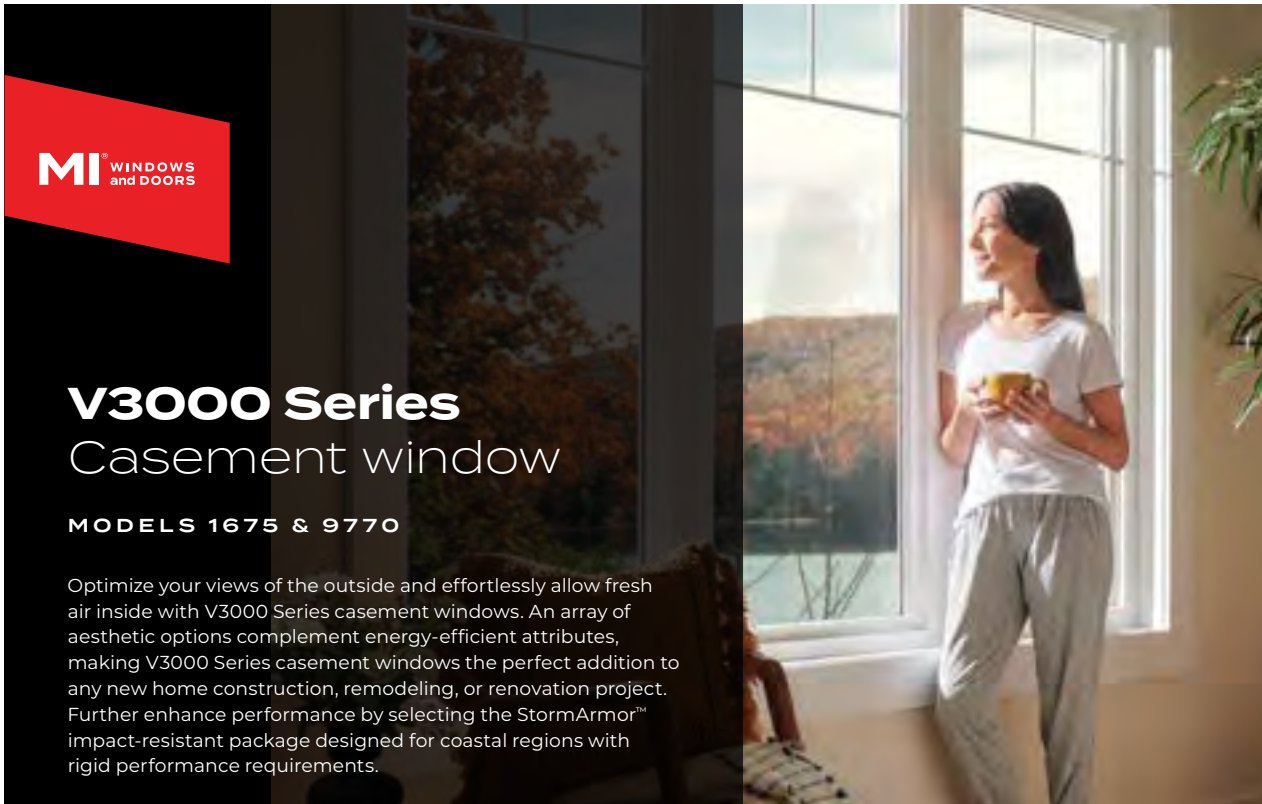

MI®
WINDOWS
and DOORS

V3000 Series Casement window

MODELS 1675 & 9770

Optimize your views of the outside and effortlessly allow fresh air inside with V3000 Series casement windows. An array of aesthetic options complement energy-efficient attributes, making V3000 Series casement windows the perfect addition to any new home construction, remodeling, or renovation project. Further enhance performance by selecting the StormArmor™ impact-resistant package designed for coastal regions with rigid performance requirements.

What you can expect

ENERGY EFFICIENCY

Our dual- and triple-pane insulated glass package options help save on heating and cooling costs while enhancing home comfort.

- In cool weather, it provides outstanding thermal performance to eliminate cold spots near windows.
- In warm weather, insulated glass reduces solar heat gain and minimizes interior glare.

CONVENIENCE AND STYLE

- Triple weatherstripping for enhanced thermal performance
- Folding operator handle with easy-to-use crank mechanics creates a clean, modern aesthetic and delivers smooth, effortless operation
- 90° hinge capability provides maximum ventilation and airflow
- Multi-point locking hardware creates a tighter, safer seal
- Low-profile screen tabs result in an unobstructed view and simple screen removal



Engineered to perform

- Welded, multi-chamber frame and sash
- 3 1/4" frame depth
- Available frame styles: finless, flange, mounting fin
- Exterior brickmould and 3 1/2" flat casing available on Model 9770
- Optional StormArmor™ package includes impact-resistant glass with argon, Cardinal LoE³-366, and preserve film to protect the glass until installation is complete
- Wood extension jambs available for 4 9/16" and 6 9/16" wall depths



Min and max sizing

WIDTH		HEIGHT	
MIN	MAX	MIN	MAX
16"	36"	24"	74"
16"	40"	24"	72"

Available in 1/8" increments.

Energy efficient glass

Optional tempered glass adds additional strength and obscure or rain glass allows light in while protecting privacy.

GLAZING TYPE	U-VALUE	SHGC	STC
Argon and Low-E glass	0.25	0.22	28
Argon and Low-E glass with grids	0.25	0.20	28
Argon and HP Low-E glass	0.26	0.18	28
Argon and HP Low-E glass with grids	0.26	0.16	28
Argon and Low-E triple-pane glass*	0.19	0.21	29
Argon and Low-E triple-pane glass with grids*	0.19	0.19	29
Impact-resistant laminated glass with Argon and LoE ³ -366	0.25	0.17	n/a
Impact-resistant laminated glass with Argon, LoE ³ -366, and grids	0.25	0.16	n/a
Impact-resistant laminated glass with Argon and LoE ³ -340	0.26	0.12	n/a
Impact-resistant laminated glass with Argon, LoE ³ -340, and grids	0.26	0.11	n/a

Note: all values based on standard 3/4" dual-pane or 1-1/8" triple-pane insulated glass unit unless noted otherwise

*Qualifies for ENERGY STAR® Most Efficient tax credit.

† Clay interior may only be combined with clay extruded exterior; not available with triple-pane glass.

‡ Woodgrain interior not available with black or clay exterior; available on 1675 model only.

§ Black interior available with black laminate exterior only.

¶ Exterior laminate available with white interior or black interior; available only on 1675 model.

** Blinds-between-the-glass available on 1675 model only; for dual-pane glass only; not available with StormArmor.

V3000 SERIES CASEMENT WINDOW
See additional product and warranty information online.



Create a customized look

Enhance your home's spaces with a variety of finish options and grid configurations.

FINISH OPTIONS

EXTERIOR	INTERIOR
White EXTRUSION	White EXTRUSION
Almond PAINT / EXTRUSION	Almond EXTRUSION
Clay PAINT / EXTRUSION	Clay EXTRUSION†
Cocoa PAINT	Hillside Oak LAMINATE‡
Cream PAINT	Natural Oak LAMINATE‡
Forest Green PAINT	Colonial Cherry LAMINATE‡
Bronze PAINT / LAMINATE¶	Black PAINT§
Black PAINT / LAMINATE¶	

GRID TYPES



BLINDS-BETWEEN-THE-GLASS**



Optional addition to let you control sunlight and privacy without the need for bulky window treatments.

SIX COLOR OPTIONS

- White
- Tan
- Sand
- Espresso
- Slate gray
- Silver moon

MI® Build boldly by choosing a range of MI window and door styles with expansive views, contemporary framing and hardware.

miwindows.com/windows/V3000/casement



What you can expect

ENERGY-EFFICIENCY

Our dual-pane insulated glass helps save on heating and cooling costs while enhancing home comfort.

- In cool weather, it provides outstanding thermal performance to eliminate cold spots near windows.
- In warm weather, insulated glass reduces solar heat gain and minimizes interior glare.

CONVENIENCE AND STYLE

- Fully welded PVC vinyl frame provides long-term durability
- Aluminum and steel reinforcements in the front mullion improve structural performance
- Vents and deadlites have a built-in weep system for optimal water drainage
- FlexScreen™ allows for maximum airflow while keeping pests out
- Inside front-mounted multi-point locks and operators ensure safety and security
- Engineered for new construction and remodeling applications

Engineered to perform

- Shipped completely assembled and ready to install
- 1" insulated glass unit with dual-pane clear glass
- Top-sloped insulated tempered glass (constant 35° pitch)
- 1 ¼" exterior grade plywood head board, seat board, and jamb
- Available with adjustable glass shelves and finely-crafted edge banding and knee brace trim
- Optional Low-E and argon for increased thermal performance

Min and max sizing

WIDTH		HEIGHT	
PROJECTION: 17" CONSTANT			
MIN	MAX	MIN	MAX
24"	60"	30"	65"
60"	72"	30"	60"
IMPACT-RESISTANT			
24"	63"	30"	63"

Create a customized look

Enhance your home's spaces with a variety of finish options and grid configurations.

FINISH OPTIONS

VINYL/EXTRUDED FRAME



White Tan

SPECIALTY FRAME COLORS



Champagne* Cocoa* Light Oak*

HEAD BOARD, SEAT BOARD, AND JAMB



Birch Veneer Oak Veneer White Laminate Tan Laminate



Light Oak Laminate Dark Oak Laminate Cherry Laminate

CORIAN SOLD-SURFACE SEAT BOARD



Arctic White Tan Vanilla Sugar Black Pearl



White Quartz Gray Granite

† Champagne and Cocoa available on exterior with white interior only
‡ Light Oak available on interior with white exterior only



V3000 GARDEN
See additional product and warranty information online.



MI[®] Build boldly by choosing a range of MI window and door styles with expansive views, contemporary framing and hardware.
miwindows.com/V3000

V3000 VINYL MODEL 1650



What you can expect

ENERGY EFFICIENCY

Our dual- and triple-pane insulated glass package options help save on heating and cooling costs while enhancing home comfort.

- In cool weather, it provides outstanding thermal performance to eliminate cold spots near windows.
- In warm weather, insulated glass reduces solar heat gain and minimizes interior glare.

CONVENIENCE AND STYLE

- Beveled exterior profile and balance channel covers create a clean, timeless aesthetic
- Dual-opposing, mortised recessed locks create a stronger, safer seal
- Latching extruded half screen with Clarity Screen™ mesh allows for optimal ventilation without compromising visibility
- Tilt-in top and bottom sash for easy cleaning
- Push-button vent stops enable ventilation without sacrificing safety and security
- Inverted-coil balances with detent clip provide smooth operation and prevent sash from drifting

Engineered to perform

- Welded, multi-chamber frame and sash
- Interlocking sash with heavy-duty weatherstripping
- Metal-reinforced meeting rail
- Combination sloping sill with upstanding leg
- 3 ¼" frame depth
- Available frame styles: finless, mounting fin
- Wood extension jambs available for 4 9/16" and 6 9/16" wall depths

Min and max sizing

WIDTH		HEIGHT	
MIN	MAX	MIN	MAX
14"	14 7/8"	36"	96"
15"	16"	28"	96"
16 1/8"	17"	26"	96"
17 1/8"	48"	23 1/2"	96"
48 1/8"	52"	23 1/2"	72"

Available in 1/8" increments. DP upgrade required for any unit greater than 84" tall

Energy efficient glass

Optional tempered glass adds additional strength and obscure or rain glass allows light in while protecting privacy.

GLAZING TYPE	U-VALUE	SHGC	STC
Argon and Low-E glass	0.28	0.26	27
Argon and Low-E glass with grids	0.28	0.23	27
Argon and HP Low-E glass	0.28	0.21	27
Argon and HP Low-E glass with grids	0.28	0.19	27
Argon and Low-E triple-pane glass	0.22	0.22	30
Argon and Low-E triple-pane glass with grids	0.23	0.20	30
Argon, Foam-enhanced frame, and Low-E triple-pane glass	0.22	0.22	30
Argon, Foam-enhanced frame, Low-E glass	0.27	0.26	30
Argon, Foam-enhanced frame, Low-E glass with grids	0.27	0.23	30
Argon, Foam-enhanced frame, and Low-E triple-pane glass with grids	0.22	0.20	30
Foam-enhanced frame, Low-E, and blinds-between-the-glass	0.35	0.23	N/A
Argon, Foam-enhanced frame, Low-E triple pane-glass with I-89*	0.20	0.22	27

Note: all values based on standard 3/4" dual-pane or 7/8" triple-pane insulated glass unit unless noted otherwise.
*Qualifies for ENERGY STAR[®] Most Efficient tax credit.



**V3000 SERIES
DOUBLE-HUNG WINDOW**

See additional product and warranty information online.





Create a customized look

Enhance your home's spaces with a variety of finish options and grid configurations.

FINISH OPTIONS

EXTERIOR	INTERIOR
White EXTRUSION	White EXTRUSION
Almond PAINT / EXTRUSION	Almond EXTRUSION
Clay PAINT / EXTRUSION	Clay EXTRUSION [†]
Cocoa PAINT	Hillside Oak LAMINATE [‡]
Cream PAINT	Natural Oak LAMINATE [‡]
Forest Green PAINT	Colonial Cherry LAMINATE [‡]
Bronze PAINT	Black PAINT [§]
Black Matte PAINT / LAMINATE [¶]	

GRID TYPES



BLINDS-BETWEEN-THE-GLASS[‡]



Optional addition to let you control sunlight and privacy without the need for bulky window treatments.

SIX COLOR OPTIONS

- White
- Espresso
- Tan
- Slate gray
- Sand
- Silver moon

[†] Clay interior available on products manufactured in Texas only; may only be combined with clay extruded exterior; not available with foam or triple-pane glass
[‡] Woodgrain interior not available with black or clay exterior.
[¶] Exterior laminate available with white interior only; has a satin finish (matte applies to black paint only).
[§] Black interior available with black laminate exterior only.
[‡] Blinds-between-the-glass available for dual-pane glass only.

MI[®] Build boldly by choosing a range of MI window and door styles with expansive views, contemporary framing and hardware.

miwindows.com/windows/V3000/double-hung



MI[™]

Blinds-Between-the-Glass



Select 1600 Series products are available with optional mini blinds-between-the-glass

The unique blinds-between-the-glass option offers a quality solution for window and sliding glass door treatments. The blinds are sealed between two panes of glass, resulting in a longer service life compared to standard blinds while also eliminating the need for dusting. Engineered for ease of use, the internal design makes raising and lowering the blinds simple and intuitive and eliminates the possibility of blinds obstructing the window or door operation.



PRODUCT FEATURES AND BENEFITS:

- Single, streamlined operator makes it easy to raise, lower and tilt the blinds for optimal sunlight and privacy
- Self-leveling bottom rail re-levels if blinds become unbalanced
- Blinds remain virtually dust-free in a sealed insulated glass unit
- Integral blinds eliminate the risk of children or pets getting entangled in cords
- Standard with Low-E coated glass for energy-efficiency and home comfort

TECHNOLOGY:

- No-slip gear belt for smooth lift and tilt operation of the blind
- Single cord-winding shaft provides improved “stack,” which prevents the blinds from coming in contact with the glass surface

TESTED FOR DURABILITY:

- Rigorously tested at 10,000+ cycles, far exceeding industry standard of 3,500 cycles
- Durable components withstand long-term operation of window or door
- Integrated mini blinds are backed by an industry-leading 10-year limited warranty for added peace of mind

NOTES:

- Blinds must be ordered in the top and bottom sash of the double-hung
- Grids are not available for products ordered with blinds
- Simulated meeting rails are not available on products with blinds
- Refer to separate chart for size availability

THERMAL PERFORMANCE:

PRODUCT <i>with blinds</i>	GLAZING TYPE	U-VALUE	SHGC
1650 Double-Hung	Low-E glass	0.36	0.23
1650 Double-Hung <i>with Foam</i>	Low-E glass	0.35	0.23
1650 Picture Window	Low-E glass	0.34	0.26
1675 Casement	Low-E glass	0.32	0.20
1675 Picture Window	Low-E glass	0.32	0.25
1615 Sliding Glass Door	Low-E glass	0.35	0.24



PGT[®]

Custom Windows and Doors

Beauty and efficiency beyond compare

Add beauty, unmatched strength, and increased energy efficiency to any home design with PGT® WinGuard® Vinyl impact windows. During a storm, these windows will not separate from your home, which can cause pressurization during extreme weather. Each one delivers our signature premium quality and performance, engineered to be durable and worry-free.



Low Maintenance
Premium vinyl delivers performance for years to come



Durable
Sturdy vinyl frame with patented corner weld provides superior strength and allows for larger window sizes



Energy Efficient
Impact windows lower your home's energy bills*. Can qualify for ENERGY STAR® rating.



Single Hung Window
SH5500



Double Hung Window
DH5560



Casement Window
CA5540
Fixed Lite Casement Picture Window
PW/AR5540



Horizontal Roller Window
HR5510



Awning Window
AW5540



Fixed Lite Picture Window
PW5520



Fixed Lite Architectural Window
AR5520

*Compared to a single pane window. Energy cost savings based on 14.4 yrs Florida average home ownership. Source: energy.gov, valuepenguin.com

SH7700A

Single Hung Window



Flexible Design
Custom design configurations with exceptional strength



Easy Opening
Heavy-duty, pre-tensioned balance system



Configurations



Equal



Proview



Cottage

Easy Opening & Closing

- ComfortLift handles
- Various balancing systems for large, small, and heavy sashes ensures effort less operation
- Constant Force or spiral balance system

Exceptional Strength

- Welded sash corners create a strong seal
- SecureConnect corner keys ensure optimal performance on any sized window
- Aluminum interlock enhances strength on larger sizes/design pressures

Hardware Options

- Vent latch allows fresh air in without opening window completely
- Window Opening Control Device that delivers a deeper level of safety and security (Certified to ASTM F2090*)

Sash Options

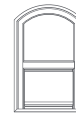

Single hung radius top with equal sash

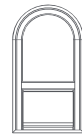

Single hung arch top with proview/oriel sash

*Window opening control devices are designed to meet the ASTM International (formerly known as ASTM - American Society of Testing and Materials) Standard Specification for Window Fall Prevention Devices with Emergency Escape (Egress) Release Mechanisms.

PGT CUSTOM WINDOWS

IMPACT DOUBLE HUNG WINDOW



DH5560

Double Hung Window



Enhanced Security

Impact glass resists intruders and features a low-profile sweep lock



Easy Opening

Heavy-duty, pre-tensioned balance system



Configurations



Equal



Proview



Cottage

Easy Opening & Closing

- ComfortLift handles
- Various balancing systems for large, small, and heavy sashes ensures effort less operation
- Constant Force or spiral balance system

Removable Sash Design

- Clean the exterior part of the window more easily

Exceptional Strength

- Welded sash corners create a strong seal
- SecureConnect corner keys ensure optimal performance on any sized window
- Aluminum interlock enhances strength on larger sizes/design pressures

Hardware Options

- Vent latch allows fresh air in without opening window completely
- Window Opening Control Device that delivers a deeper level of safety and security (Certified to ASTM F2090*)

*Window opening control devices are designed to meet the ASTM International (formally known as ASTM - American Society of Testing and Materials) Standard Specification for Window Fall Prevention Devices with Emergency Escape (Egress) Release Mechanisms.

CA5540

Casement Window



Easy Ventilation

Opens on either left- or right-hand side



Added Security

Best performing option for extreme weather and built with innovative multi-point locking system



CA5540 Casement Window

Modular Design

- Available in single, double, or triple unit for versatile left or right opening
- Pair with a matching Awning and Fixed Lite Casement Picture Window for design flexibility

Multi-Point Locking System

- Provides added strength and security

Exceptional Strength

- TrueHold hinge ensures durable sash operation on larger windows

Hardware

- Foldaway handle won't interfere with window treatments
- Washable hinge for easy cleaning from inside the home
- Window Opening Control Device that delivers a deeper level of safety and security (Certified to ASTM F2090*)

PW/AR5540

Fixed Lite Casement Picture Window/ Architectural

Fixed (Non-Operable) Window:

- Allows flexibility in design for multiple window configurations
- Suitable for most bedrooms and living spaces
- Works well as a standalone or companion window
- Matching Casement and Awning Windows available
- Available in a variety of architectural shapes and sizes

*Window opening control devices are designed to meet the ASTM International (formerly known as ASTM - American Society of Testing and Materials) Standard Specification for Window Fall Prevention Devices with Emergency Escape (Egress) Release Mechanisms.

PGT CUSTOM WINDOWS

IMPACT HORIZONTAL ROLLER WINDOW



HR5510

Horizontal Roller Window



Design Versatility
Available in 2- and 3-lite configurations



Easy Opening and Closing
Made with tandem stainless-steel bearings



Configurations

- Equal Lite
- Unequal Lite

Exceptional Strength

- Welded sash corners create a strong seal
- SecureConnect corner keys ensure optimal performance on any sized window
- Aluminum interlock enhances strength on larger sizes/design pressures

Low-Profile Sweep Lock

- Adds an extra level of security
- Maximizes the view

Removable Sash Design

- Clean the exterior part of the window more easily

Hardware Options

- Vent latch allows fresh air in without opening window completely
- Window Opening Control Device that delivers a deeper level of safety and security (Certified to ASTM F2090*)

*Window opening control devices are designed to meet the ASTM International (formally known as ASTM - American Society of Testing and Materials) Standard Specification for Window Fall Prevention Devices with Emergency Escape (Egress) Release Mechanisms.

AW5540

Awning Window



Hinged at the Top

To keep out rain but allow light and ventilation



Custom Configurations

Can be mullered vertically or horizontally

Modular Design

- Individual vent units can be mullered vertically or horizontally
- Matching Casement and Fixed Lite Casement Picture Windows

Hardware

- Foldaway handle won't interfere with window treatments
- Multi-point locking system adds an extra layer of strength and security



PW5520

Fixed Lite Picture Window



Design Flexibility

Pairs with other window shapes for a custom look. Great for creating a wall of windows.



Abundant Sunlight

Allows for the perfect view and natural light to fill the space

Fixed (Non-Operable) Window

- Works well as a standalone or companion window
- Allows flexibility in design for multiple window configurations

Modular Design

- Many matching window options available
- Enhances the look of living rooms, kitchens, and master bedrooms
- Individual units can be milled for a variety of shapes and sizes to create a unique vignette that's custom to your home
- Many popular grid options available. Check with your local dealer.



AR5520

Fixed Lite Architectural Window



Visual Appeal

Available in an array of interesting shapes and can be customized to order



Abundant Sunlight

Allows natural light to fill the space

Fixed (Non-Operable) Window

- Works well as a standalone or companion window
- Allows flexibility in design for multiple window configurations

Modular Design

- Many matching window options available
- Enhances the look of living rooms, kitchens, and master bedrooms
- Individual units can be milled for a variety of shapes and sizes to create a unique vignette that's custom to your home
- Many popular grid options available. Check with your local dealer.



Half Circle



Octagon



Circle



Trapezoid



Arch



Eyebrow

Popular Architectural shapes shown.



FRAME COLORS

Powder-coated frames resist chipping, corrosion, and fading. Custom frame colors are also available. Multi-chambered frame provides outstanding energy savings.

- Black
- Bronze
- Beige
- White

SCREENS

Fiberglass Screen Mesh

-  18x16
-  Charcoal or Gray

BetterVue® (Optional)
Insect screening with
Water Shed Technology™



GLASS OPTIONS

With over 7,200 glazing options possible, you can create the right look for any window shape, size, or style. WinGuard® Vinyl products offer superior energy efficiency and many options to achieve ENERGY STAR® ratings with customized glass options like gas fills, tints, and coatings.

Argon Gas

(Laminated insulating glass only)

Windows can be filled with colorless and odorless argon gas to help insulate a room and minimize the transfer of heat through the window

Low-E (Emissivity) Glass

High performance coated glass that reflects and filters heat to keep your home comfortable

Impact Laminated Glass

Laminated glass for effortless impact resistance

Impact Laminated Insulating Glass

Highly customizable option that delivers increased energy efficiency and sound dampening

Privacy Glass

White Interlayer, Obscure glass, Obscure with White Interlayer, or Textured glass options

GRID TYPES

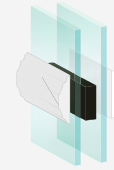

Traditional Simulated Divided Lite Grid

7/8" wide raised ogee applied to exterior and interior with 9/16" wide bronze shadow bar



Flat Grid

9/16" wide or 13/16" wide grid between the glass



Contour Grid

1" wide grid between the glass

GLASS TINTS



Clear



Bronze



Gray



Green



Azure Blue



Solarcool® Bronze



Graylite® II



Turtle Glass

Tinted to reduce light and protect the natural habitat of marine turtles. Ask your dealer to learn more.

GRID STYLES

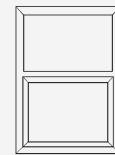

None

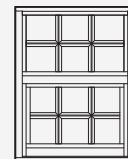

Colonial
(Many options available)

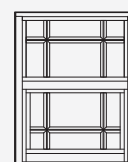

Brittany / Prairie



1258



SERIES 500

SINGLE HUNG, SINGLE SLIDER AND FIXED UNITS



Window Features:

- AAMA-certified profiles, multi-chambered for enhanced rigidity and thermal performance
- Fusion-welded corners for superior strength, weather resistance, and longevity
- Insulated 3/4" glass for energy efficiency
- Available in white, almond, and clay base colors
- Optional exterior capstock available in black
- Exterior-glazed 2-9/16" beveled frame complements any architectural style
- Matching horizontal slider available
- Integral nailing fin with 1-1/8" set-back
- Integral interlocks and lift handle at the meeting rail
- Take-out bottom sash with block & tackle balances for easy operation
- AAMA DP-50 rated for air, water, and structural performance
- Meets emergency egress requirements (35-1/2" x 59-1/2" unit)
- Energy Star compliance possible (dependent on glazing options)
- Optional vent stop available
- Common jamb for twin units with continuous frame
- Special shapes available for design flexibility



PERFORMANCE DATA

Window Type	Grids	U-Factor	SHGC	VT
Single Hung - Air	No	0.32	0.21	0.47
Single Hung - Air	Yes	0.32	0.19	0.42
Single Hung - ARGON	No	0.29	0.21	0.47
Single Hung - ARGON	Yes	0.29	0.19	0.42
Slider - Air	No	0.32	0.22	0.47
Slider - Air	Yes	0.32	0.19	0.42
Slider - ARGON	No	0.29	0.21	0.47
Slider - ARGON	Yes	0.29	0.19	0.42
Picture Window - Air	No	0.3	0.23	0.51
Picture Window - Air	Yes	0.3	0.21	0.46
Picture Window - ARGON	No	0.26	0.21	0.51
Picture Window - ARGON	Yes	0.26	0.2	0.46



CARDINAL IG



abiwindows.com

SERIES 700 RESIDENTIAL

SINGLE HUNG, SINGLE SLIDER AND FIXED UNITS

Window Features:

- Foam filled AAMA-certified profiles, multi-chambered for enhanced rigidity, noise control and overall thermal performance
- Fusion-welded corners for superior strength, weather resistance, and longevity
- Insulated 3/4" glass for energy efficiency
- Available in white, almond, and clay base colors
- Optional exterior capstock available in black
- Exterior-glazed 2-9/16" beveled frame complements any architectural style
- Matching horizontal slider available
- Integral nailing fin with 1-1/8" set-back
- Integral interlocks and lift handle at the meeting rail
- Removable bottom sash with block & tackle balances for easy operation
- AAMA DP-50 rated for air, water, and structural performance
- Meets emergency egress requirements (35-1/2" x 59-1/2" unit)
- Energy Star compliance right out of the package
- Optional vent stop available
- Common jamb for twin units with continuous frame
- Special shapes available for design flexibility



UNLOCK OUR WINDOW TO YOUR FUTURE



PERFORMANCE DATA

Window Type	Grids	U-Factor	SHGC	VT
Single Hung - ARGON	No	0.28	0.20	0.47
Single Hung - ARGON	Yes	0.28	0.19	0.42
Slider - ARGON	No	0.28	0.21	0.47
Slider - ARGON	Yes	0.28	0.19	0.42
Picture Window - ARGON	No	0.26	0.22	0.51
Picture Window - ARGON	Yes	0.26	0.20	0.51







ATRIUM[®]

WINDOWS & DOORS

SERIES 5700

VINYL SIDE-LOAD SINGLE HUNG WINDOW

- + Removable bottom sash
- + Industry leading air infiltration performance
- + 1 ¼" Nail-fin setback for brick veneer construction and select stucco applications
- + Sweep lock helps provide a weather-tight seal and added security
- + Dual weather-stripping helps block air and water infiltration, keeping harsh elements outside and energy-saving comfort inside
- + Versatile half screen* installs easily from inside
- + Double insulated glass provides energy saving efficiency. A host of glass options are available, including Low-E coatings and Argon Gas fill for additional efficiency and ENERGY STAR® compliance
- + Sloped sill reduces air infiltration and accommodates easy water run-off
- + Multi-chambered vinyl lineals improve thermal performance and enhance sound absorbency
- + Built-in accessory channels accommodate multiple installation options
- + Block and Tackle Balance System for ease of operation
- + Fusion-welded frame and sash minimizes water and air infiltration and enhances overall durability
- + Removable operable sash makes cleaning a breeze. Also includes full length interlock and bottom weather stripping
- + Limited lifetime warranty provides reassuring peace of mind
- + Pre-punched integral nail-fin targets proper nail location for quick, easy installation
- + Modular sized so that rough opening widths for multiple units are easy to calculate:
 - 5700 Single = 35.5"
 - 5700 Twin = 71.5"
 - 5700 Triple = 107.5"
- + DP Rating R50 (window size tested 36" x 96")
- + Jamb depth: 2.625"



CUSTOM Options

- + Low-E Glass
- + Low-E Glass + Argon Gas
- + Ultra Low-E Glass + Argon Gas
- + ⅝" or ¾" flat, ⅝" or 1" contoured, ⅝" contoured valance grids available
- + Factory mulling of twins, triples and architectural shapes
- + Custom sizes available
- + Safety latch for sash restriction (field applied)
- + Paintable or stainable wood jamb extensions (4 ⅞" and 6 ⅞")

+ COLOR OPTIONS**

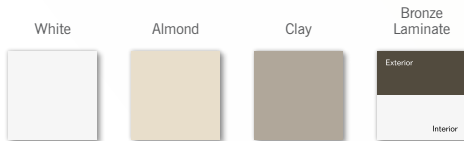

www.atrium.com



ENERGY STAR compliance available in all series. Verify product specifics before ordering.



Note: Manufacturer reserves the right to substitute components as necessary for continued product improvement.
 *Screens are not meant to restrain a child from falling through an open window.
 ** Printing process may affect color shown. Please refer to actual window sample when selecting colors. REV 2/20 TX

A DIVISION OF CORNERSTONE BUILDING BRANDS

SERIES 5700

VINYL HORIZONTAL SLIDING WINDOW

- + **1 ¼" Nail-fin setback** for brick veneer construction and select stucco applications
- + **Sweep lock** helps provide a weather-tight seal and added security
- + **Dual weather-stripping** helps block air and water infiltration, keeping harsh elements outside and energy-saving comfort inside
- + **Versatile half screen*** installs easily from inside
- + **Double insulated glass** provides energy saving efficiency. A host of glass options are available, including Low-E coatings and Argon gas fill for additional efficiency and ENERGY STAR® compliance
- + **Multi-chambered vinyl lineals** improve thermal performance and enhance sound absorbency
- + **Fusion-welded frame and sash** minimizes water and air infiltration and enhances overall durability
- + **Metal reinforced meeting rail and sash rail** provide added durability and enhanced security
- + **Limited lifetime warranty** provides reassuring peace of mind
- + **Pre-punched integral nail-fin** targets proper nail location for quick, easy installation
- + **Tandem wheel and axle roller assemblies** ensure smooth, easy operation on even the largest sizes
- + **Multi-cavity vinyl lineals** improve thermal performance and enhance sound absorbency
- + **DP Rating R25**
(window size tested 72" x 48")
- + **Jamb depth: 2.625"**



www.atrium.com

CUSTOM Options

- + **Low-E Glass**
- + **Low-E Glass + Argon Gas**
- + **Ultra Low-E Glass + Argon Gas**
- + **5/8" or 3/4" flat, 5/8" or 1" contoured, 5/8" contoured valance grids available**
- + **Custom sizes available**
- + **Paintable or stainable wood jamb extensions (4 9/16" and 6 9/16")**

+ COLOR OPTIONS**

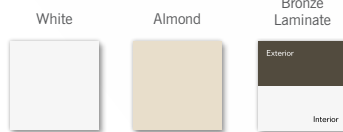

ENERGY STAR compliance available in all series. Verify product specifics before ordering.



Note: Manufacturer reserves the right to substitute components as necessary for continued product improvement.

*Screens are not meant to restrain a child from falling through an open window.

**Printing process may affect color shown. Please refer to actual window sample when selecting colors. REV 2/20 TX

A DIVISION OF CORNERSTONE BUILDING BRANDS

SERIES 150 SINGLE HUNG WINDOW

Single hung, slider, picture windows and architectural shapes

- + Beautiful, true brick mould exterior frame perimeter
- + Bottom sash tilts in for easy cleaning
- + Fully welded frame and sash corners
- + Sloped sill for easy water run-off
- + DP-50 Rating (window size tested 36" x 74")
- + Integrated J-channel (Series 160 available without J-channel)
- + Pre-punched nail fin makes installation simple
- + Insulated glass panels with optimum thermal air space featuring warm-edge spacer system
- + Block and tackle balance system
- + Continuous head and sill on twins and triples
- + Half screen comes standard*
- + Jamb depth: 3.277"
- + Matching slider series 151 available in 2- and 3-lite styles
- + Limited lifetime warranty



CUSTOM Options

- + Low-E Glass
- + Low-E Glass + Argon Gas
- + Ultra Low-E Glass + Argon Gas
- + 5/8" or 3/4" flat, 5/8" or 1" contoured, 1 1/8" simulated divided lite (SDL), 5/8" contoured valance grids available
- + Nine painted exterior colors (white interior only)
- + Factory mulling of twins, triples and architectural shapes
- + Paintable or stainable wood jamb extensions (4 1/16" and 6 1/16")
- + Exterior 3 1/4" flat casing with Sill Nose DP-35 Rating (window size tested 36" x 74")
- + Charcoal aluminum mesh screen*
- + Window Opening Control Device (W OCD)
- + Custom sizes available



Brick Mould Exterior



Pre-punched nailing fins and integrated J-channel



3 1/4" flat casing with sill nose

+ VINYL COLOR** OPTIONS



+ EXTERIOR LAMINATE COLOR** OPTION

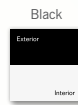

Not available with: Series 160, SDL grid, or flat casing.

+ PAINTED EXTERIOR COLOR** OPTIONS

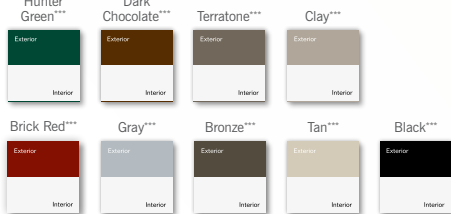

www.atrium.com



Select styles and glass packages can be ordered to meet ENERGY STAR® 7 guidelines. See your Atrium Territory Sales Manager for details.



Note: Manufacturer reserves the right to substitute components as necessary for continued product improvement.

* Screens are not meant to restrain a child from falling through an open window.

** Printing process may affect color shown. Please refer to actual window sample when selecting colors.

*** Grid offering limited to 5/8" contoured or SDL on exterior painted windows. Only use mild, water based household cleaner on painted product and rinse immediately with water. See full cleaning instructions for details. REV 11/23

A DIVISION OF CORNERSTONE BUILDING BRANDS

SERIES 450 DOUBLE HUNG WINDOW

Double hung, picture windows and architectural shapes

- + Beautiful, true brick mould exterior frame perimeter
- + Both sashes tilt in for easy cleaning
- + Fully welded frame and sash corners
- + Sloped sill for easy water run-off
- + Insulated glass panels with optimum thermal air space featuring warm-edge spacer system
- + DP-35 Rating (available with DP-50 option, window size tested 36" x 74")
- + Series 455/465 available with DP-50 Rating
- + Integrated J-channel (Series 460 available without J-channel)
- + Pre-punched nail fin makes installation simple
- + Block and tackle balance system
- + Continuous head and sill on twins and triples
- + Half screen comes standard*
- + Jamb depth: 3.868"
- + Matching slider #451 available in 2- and 3-lite styles
- + Limited lifetime warranty



CUSTOM Options

- + Low-E Glass
- + Low-E Glass + Argon Gas
- + Ultra Low-E Glass + Argon Gas
- + Dual push-button night vents for secure ventilation
- + 5/8" or 3/4" flat, 5/8" or 1" contoured, 1 1/8" simulated divided lite (SDL), 5/8" contoured valance grids available
- + Nine painted exterior colors (white interior only)
- + Exterior 3 1/4" flat casing with Sill Nose
- + Factory mulling of twins, triples and architectural shapes
- + Paintable or stainable wood jamb extensions (4 5/16" and 6 5/16")
- + Brass or brushed nickel locks
- + Charcoal aluminum mesh screen*
- + Window Opening Control Device (WOCD)
- + Custom sizes available



Featuring Our New Low Profile Lock



www.atrium.com



Select styles and glass packages can be ordered to meet ENERGY STAR® 7 guidelines. See your Atrium Territory Sales Manager for details.



Note: Manufacturer reserves the right to substitute components as necessary for continued product improvement.
 * Screens are not meant to restrain a child from falling through an open window.
 ** Printing process may affect color shown. Please refer to actual window sample when selecting colors.
 *** Grid offering limited to 5/8" contoured or SDL on exterior painted windows. Only use mild, water based household cleaner on painted product and rinse immediately with water. See full cleaning instructions for details. REV 11/23



Pre-punched nailing fins and integrated J-channel



3 1/4" flat casing with sill nose

+ COLOR OPTIONS**

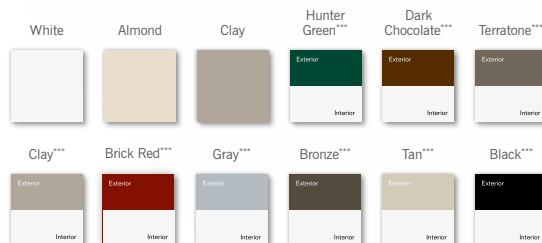

A DIVISION OF CORNERSTONE BUILDING BRANDS

SERIES 750 CASEMENT WINDOW

Series 755 awning window also available

- + Beautiful, true brick mould exterior frame perimeter
- + Low profile handle folds in and provides a popular aesthetic appeal
- + Narrow profile permits expanded viewing area
- + Fusion-welded frame and sash ensure weather-tight performance
- + Full-perimeter double weather stripping
- + Pre-punched nail fin makes installation simple
- + Insulated glass panels with optimum thermal air space featuring warm-edge spacer system
- + Concealed hinges and hardware let you open casement windows 90 degrees for better ventilation and easier cleaning
- + Full screens mount on the interior and are removable for easy cleaning*
- + Tandem locks come standard on all casements over 34" in height
- + Jamb depth: 3.25"
- + Multi-point locking system provides superior pull-in mechanism with single lever
- + Limited Lifetime Warranty



Single vent casement

CUSTOM Options

- + Low-E Glass
- + Low-E Glass + Argon Gas
- + Ultra Low-E Glass + Argon Gas
- + 5/8" or 3/4" flat, 5/8" or 1" contoured, 1 1/8" simulated divided lite (SDL), 5/8" contoured valance grids available
- + 2" simulated meeting rail
- + Charcoal aluminum, Clear View and heavy duty screens**
- + Nine painted exterior colors (white interior only)



Brick mould exterior



Low profile handle



Pre-punched nail fin



Single vent awning



www.atrium.com

+ COLOR OPTIONS**

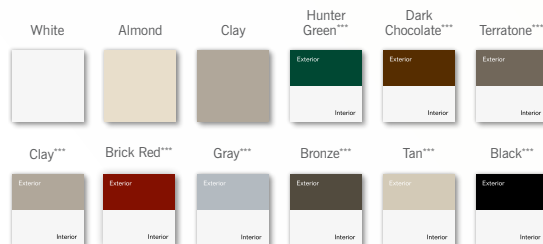

Select styles and glass packages can be ordered to meet ENERGY STAR® 7 guidelines. See your Atrium Territory Sales Manager for details.



Note: Manufacturer reserves the right to substitute components as necessary for continued product improvement.
 * Screens are not meant to restrain a child from falling through an open window.
 ** Printing process may affect color shown. Please refer to actual window sample when selecting colors.
 *** Grid offering limited to 5/8" contoured or SDL on exterior painted windows. Only use mild, water based household cleaner on painted product and rinse immediately with water. See full cleaning instructions for details. REV 11/23

A DIVISION OF CORNERSTONE BUILDING BRANDS



Quarter Round

ENGINEERED FOR THAT PERFECT ARCHITECTURAL TOUCH

Create a window system that truly stands out—from octagons and trapezoids to full circles, half rounds, eyebrows and more, we can custom craft any specialty window to fulfill your visions.



Colonial Arch Flanker



Colonial Flanker

- + Standard sizes are available plus a full range of architectural options to accommodate any building style, from colonial to contemporary, from Cape Cod to Southwest
- + Factory mulling is at your calling for quick, hassle-free installation
- + Insulated glass panels with optimum thermal air space featuring a warm-edge spacer system
- + Operable eyebrows and half eyebrows available in Series 150/160 operate sash
- + Optional wood jamb extensions (paintable or stainable pine 4 1/2" and 6 1/2" available)
- + Limited lifetime warranty



Colonial Arch



Operable Eyebrow



Half Round



Half Eyebrow



Full Round



Eyebrow Transom



Oval



Elliptical



Triangle



Octagon



Pentagon



Trapezoid



Eyebrow

ARCHITECTURAL SHAPES

Quarter Round

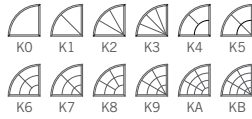

Half Round

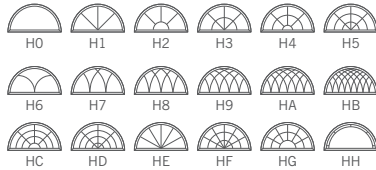

Elliptical



Eyebrow Transom

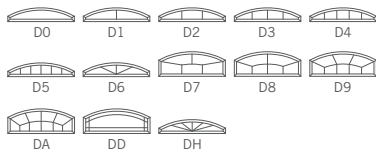

Eyebrow

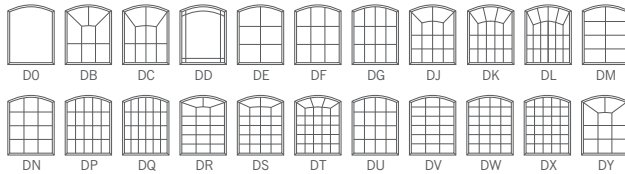

Colonial Arch

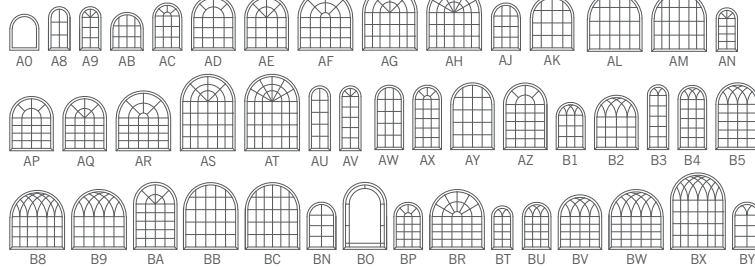

Colonial Arch Flanker

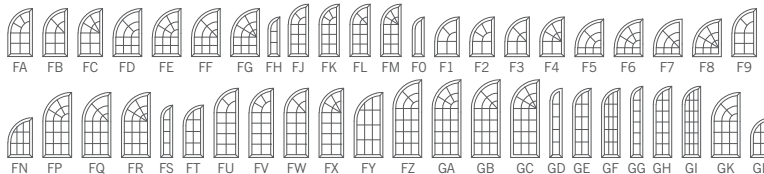

Full Round



Oval

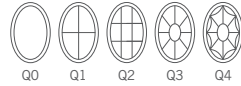

Octagon

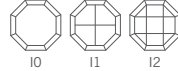

Triangle



Trapezoid



Pentagon



Half Eyebrow



Colonial Flanker



AVAILABLE OPTIONS FOR NEW CONSTRUCTION

- + Low-E Glass
- + Low-E Glass + Argon Gas
- + Ultra Low-E Glass + Argon Gas
- + Obscure glass
- + Double strength glass
- + 5/8" or 3/4" flat grid
- + 5/8" or 1" contoured grid
- + 1 1/8" Simulated Divided Lite grid (vertical or horizontal only)
- + White, Almond, Clay Vinyl Colors

AVAILABLE OPTIONS FOR REPLACEMENT

- + Low-E Glass
- + Low-E Glass + Argon Gas (standard on Series 8900 & 8700 only)
- + Ultra Low-E Glass + Argon Gas
- + Obscure glass
- + Double strength glass
- + 5/8" or 3/4" flat grid
- + 5/8" or 1" contoured grid
- + 1 1/8" Simulated Divided Lite grid (Series 8900 and 8700 only; vertical or horizontal only)
- + White, Almond Vinyl Colors
- + Interior Wood Laminates (Series 8900 only; no grid)
- + Exterior Bronze Laminate (Series 8700 only; no grid)
- + Nine Exterior Painted Colors (Series 8900 & 8300 only; no grid)
- + InsulKor Foam Filled Frame (Series 8900 only)
- + Super Spacer nXt Glass (Series 8900 only)
- + Triple Pane Low-E with Argon (Series 8900 only)
- + Triple Pane Ultra Low-E with Argon (Series 8900 only)
- + Decorative Glass (Series 8900 only)
- + Lifetime Glass Breakage Warranty (standard on 8900)

* Printing process may affect color shown. Please refer to actual window sample when selecting colors.

Manufacturer reserves the right to substitute components as necessary. Screens are not meant to restrain a child from falling through an open window.

A Wide Range of Grid Styles

Our between-the-panes and simulated divided lite (SDL) grid options enhance the cosmetic appeal of any home and make cleaning simple.

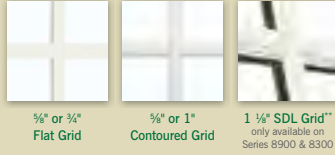

3/8" or 3/4" Flat Grid

3/8" or 1" Contoured Grid

1 1/2" SDL Grid™ only available on Series 8900 & 8300

ENERGY SMART OPTIONS FROM ATRIUM

Atrium windows and doors are engineered with state-of-the-art glass technology to give you outstanding thermal efficiency. With a full range of glass options and special insulated spacers, we have a glass package to fit any climate need or budget.

ENERGY STAR Climate Zone Map

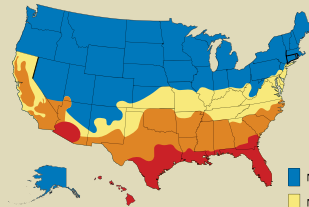

Criteria for Windows

Climate Zone	U-Factor	SHGC	Prescriptive Equivalent Energy Performance
Northern	≤ 0.27	Any	Equivalent Energy Performance
	≥ 0.28	≥ 0.32	
	≥ 0.29	≥ 0.37	
North/Central	≤ 0.30	≤ 0.40	Equivalent Energy Performance
	≥ 0.30	≥ 0.42	
South/Central	≤ 0.30	≤ 0.25	Equivalent Energy Performance
	≥ 0.30	≤ 0.25	
Southern	≤ 0.40	≤ 0.25	Equivalent Energy Performance
Air Leakage Rating:	≤ 0.3 cfm/ft²		

■ Northern Climate Zone ■ South/Central Climate Zone
■ North/Central Climate Zone ■ Southern Climate Zone



ENERGY STAR compliance available in all series. Verify product specifics before ordering.

AVAILABLE COLOR OPTIONS FOR NEW CONSTRUCTION

+ VINYL COLOR OPTIONS*

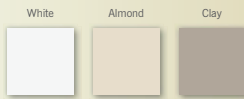

+ PAINTED COLOR OPTIONS*



AVAILABLE COLOR OPTIONS FOR REPLACEMENT

+ VINYL COLOR OPTIONS*



+ PAINTED COLOR OPTIONS*

Note: Paint available only on Series 8900 & 8300; no grid



+ LAMINATED COLOR OPTIONS*

Note: Interior Wood Laminate available only on 8900; Exterior Bronze Laminate available only on 8700; no grid

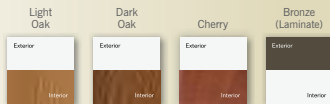

Low-E Glass

Low-E glass is coated with a microscopic layer of silver that reflects radiant solar energy while permitting visible light to pass through the glass, providing more comfort and lower energy costs.



Low-E Glass + Argon Gas

Argon gas works like an insulating blanket between two panes of glass to further improve thermal efficiency and decrease outside sound levels. (Standard on Series 8900 & 8700 only)



Ultra Low-E Glass + Argon Gas

Choose our ultimate glass package for optimal energy efficiency and maximum cost savings. Ultra Low-E glass offers three invisible layers of silver coating in addition to the superior thermal performance of argon gas.

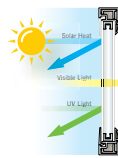

+ Low-E glass reduces heat gain from the sun in the summer, keeping your home cooler.



+ In the winter, Low-E glass lets the warm solar rays in while blocking the heat in your home from getting out.

energy efficient



SIMULATED DIVIDED LITE (SDL) GRID

We are proud to offer a traditional simulated divided lite raised-style grid on interior and exterior window and door surfaces.

Simulated Divided Lite is available on the following products:

Replacement

- + Series 8700 Double Hung
- + Series 8900 Double Hung
- + Series 700 Casement
- + Series 705 Awning

New Construction

- + Series 130 Single Hung
- + Series 150 and Series 160 Single Hung
- + Series 450 and Series 460 Double Hung
- + Series 750 Casement
- + Series 755 Awning

Patio Doors

- + Series 312 and 332

Also includes picture windows, architectural shapes and sliders of these series.



Series 8900 with SDL

Features

- + A handcrafted look for any home, especially great for use in historical districts
- + Grids are color-matched and affixed permanently to the frame, providing the look of authentic divided lites
- + Grid size: 1 1/8"
- + One-week delivery

+ COLOR OPTIONS*

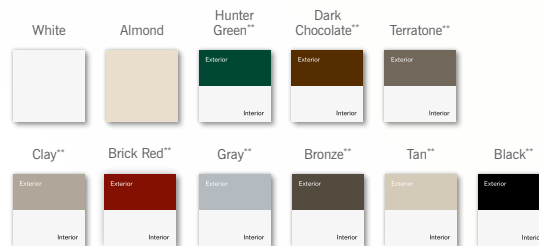

www.atrium.com



Select styles and glass packages can be ordered to meet ENERGY STAR[®] 7 guidelines. See your Atrium Territory Sales Manager for details.



Note: Manufacturer reserves the right to substitute components as necessary for continued product improvement.

*Printing process may affect color shown. Please refer to actual window sample when selecting colors.

**Grid offering limited to 5/8" contoured or SDL on exterior painted windows. Only use mild, water based household cleaner on painted product and rinse immediately with water. See full cleaning instructions for details. REV 11/23

A DIVISION OF CORNERSTONE BUILDING BRANDS



Series 5700 shown here
bronze laminate exterior
with white interior

The beauty of bronze windows for your home. Our bronze exterior laminate is available on:

AVAILABLE ON

- + Series 5700 New Construction
- + Series 130 New Construction (available on fin only and box frames)
- + Series 8050 Replacement
- + Series 8700 Replacement (also available with contoured grid)

AVAILABLE WITH

- + Single Hung and Picture Window Styles
- + 5/8" flat grid



1/2" Flat Grid
(interior view only)



1/2" or 1" Contoured Grid
(interior view only - available on 5700 only)

Contact your window representative for more details. The timeless style of bronze.





**BLACK EXTERIOR PAINT
AVAILABLE NOW**

Black windows are increasingly popular with homeowners. We are pleased to offer it on these quality Atrium products:

NEW CONSTRUCTION products:

SERIES 450 DOUBLE HUNG
(Including 455, 460, 465, 451 & 461)

SERIES 150 SINGLE HUNG
(Including 160, 151, 161 & Operable Shapes)

SERIES 130 SINGLE HUNG
(Including all Four Frame Types & Operable Shapes)

SERIES 750 CASEMENTS
SERIES 755 AWNINGS

REPLACEMENT products:

SERIES 8900 DOUBLE HUNG
(Including Picture Windows and 2 & 3-Life Sliders)

SERIES 8300 DOUBLE HUNG
(Including Picture Windows and 2 & 3-Life Sliders)

SERIES 700 CASEMENTS
SERIES 705 AWNINGS

SERIES 312 & 332 SLIDING PATIO DOORS
*Not available with 4-pane (2 patio doors)



*** PAINTED COLORS AVAILABLE ****



Color options can be purchased via WindowWizard. Available with white interior only.
5/8" contrast and SDL grid option available depending on particular Series. Contact Atrium representative or visit atrium.com for more details.

File: Manufacturer reserves the right to change product specifications or discontinue products without notice.
**Always use proper color matching techniques. Please refer to color swatch books when selecting color.
Do not use color-matching services to provide product and color information.



atrium.com





Krestmark®

Westlake
Royal Window Solutions™Krestmark® Collection
200-275 Series – New Construction

Series 200 is cleanly designed with a smooth beveled exterior profile giving it a nice bold appearance. Series 275 has a profiled exterior simulating wood brick moulding. Available in Single Hung, Picture Window, Horizontal Slider and Architectural Shapes in White, Sandstone and Clay. Series 200 available in Black/White laminate.

- Multi-chambered, fusion-welded, extruded-vinyl frame and sash provides stability and strength, thermal-resistant properties, and is extremely low maintenance.
- Tilt-in removable bottom sash for ease of cleaning has dual sash locks on units 18" and wider, reducing air infiltration; recessed tilt latches, integral lift rail adds strength.
- Metal reinforced meeting rail for added strength, positive locking and reduced air infiltration.
- Sill features a combined sloped and weep system, ensuring quick and easy water run off.
- Integral pre-punched nail fin adds strength, a weather tight barrier and ease of installation.
- Dual-weatherstrip system reduces infiltration to meet or exceed national testing standards.
- Dual pane 3/4" clear insulated glass with Warm Edge Spacer.
- Block and tackle balances provide smooth operation; locking shoes prevent sash from falling out when tilting for cleaning or removal.

Krestmark® Collection

200 Series – New Construction

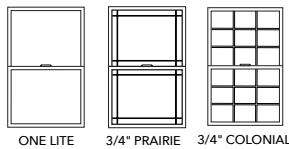
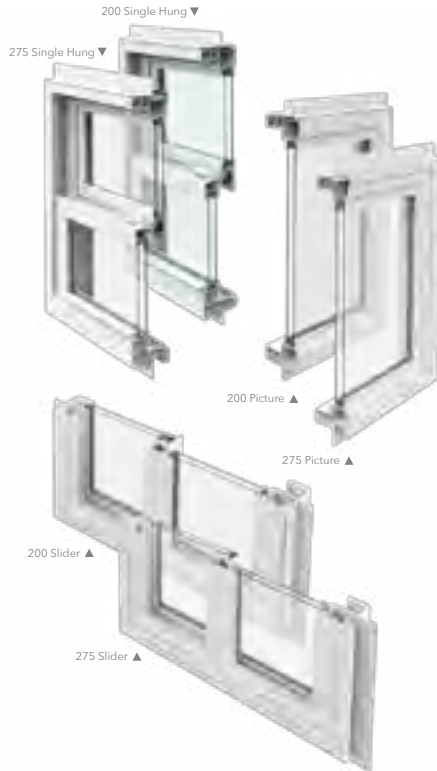

CARDINAL IG

NFRC PERFORMANCE RATINGS (3/4\"/>

SINGLE HUNG	Glass Type Exterior + Interior	Gap Fill	Grid Option	NFRC Performance Ratings			EnergyStar® v7 Climate Zone Compliance		
				U-F	SHGC	VT	Southern	S. Central	N. Central
Standard	LoE-366 + Clear	Air	no Grid	0.33	0.22	0.51	No	No	No
			with Grid	0.33	0.20	0.46	No	No	No
			Argon	0.30	0.22	0.51	Yes	No	No
STC rated (STC = 29) requires DSB + 3/16\"/>									

HORIZONTAL SLIDER	Glass Type Exterior + Interior	Gap Fill	Grid Option	NFRC Performance Ratings			EnergyStar® v7 Climate Zone Compliance		
				U-F	SHGC	VT	Southern	S. Central	N. Central
Standard	LoE-366 + Clear	Air	no Grid	0.33	0.22	0.51	No	No	No
			with Grid	0.33	0.20	0.46	No	No	No
			Argon	0.29	0.22	0.51	Yes	No	No
STC rated (STC = 29) requires DSB + 3/16\"/>									

PICTURE WINDOW	Glass Type Exterior + Interior	Gap Fill	Grid Option	NFRC Performance Ratings			EnergyStar® v7 Climate Zone Compliance		
				U-F	SHGC	VT	Southern	S. Central	N. Central
Standard	LoE-366 + Clear	Air	no Grid	0.32	0.23	0.54	Yes	No	No
			with Grid	0.32	0.21	0.49	Yes	No	No
			Argon	0.28	0.23	0.54	Yes	Yes	No
STC rated (STC = 31) requires DSB + 3/16\"/>									

Unless specified, the NFRC values & Energy Star compliance are for double glazed, SSB (3/32\"/>

Please visit WestlakeRoyalWindows.com for more information.

You may qualify for a tax credit when you replace your existing windows. For more information, go to energystar.gov



Westlake
Royal Window Solutions™

Krestmark® Collection
250 Series – New Construction



The Series 250 casement, awning and picture windows are primarily used for new construction. The actual unit size, however, is 1/2" under call out and is manufactured in some of the most common sizes used for replacement window installations. For some of these replacement applications the integral nail fin could be removed.

- Multi-chambered, extruded vinyl frame and sash provide stability with excellent strength, thermal-resistant properties and is extremely low maintenance.
- Fusion-welded corners in frame and sash provides strength and virtually eliminates air and water infiltration.
- Single, twin and triple casements, awnings, picture combinations, 1/4 and 1/2 rounds, arches and eyebrows are available as mulled transoms.
- 3/4" insulated glass, warm-edge spacer, energy-efficient LoE coating option. Type and look of warm edge spacer may vary.
- Multi-point locking hardware with hinged-side snubber, folding handle to minimize window treatment interference, and sash alignment wheel.
- Dual-durometer, double weather strip, energy-efficient system with welded corners for excellent performance and resistance to weather penetration.
- Certifications of all products tested are done to meet or exceed national testing standards by NFRC and AAMA; Energy Star® partner; TDI approval.
- Argon-enhanced glass improves energy efficiency.
- Tempered obscure, bronze or grey glass; 3/4" dual-insulated clear glass.
- Grille patterns: 3/4" Colonial, Prairie, 1" Contoured and 1-1/8" Simulated Divided Lite.
- Factory mulled or stacked units and field mull accessories.

Note: All picture windows, shapes and one-frame glass larger than 30 square feet will come with Tempered Glass as standard for safety reasons. All additional charges for Tempered Glass will automatically be applied.

Krestmark® Collection 250 Series – New Construction



NFRC PERFORMANCE RATINGS (3/4" overall IG with Quanex Duralite spacer)

CASEMENT	Glass Type Exterior + Interior	Gap Fill	Grid Option	NFRC Performance Ratings			EnergyStar® v7 Climate Zone Compliance		
				U-F	SHGC	VT	Southern	S.Central	N.Central
				Standard	LoE-366 + Clear	Air	no Grid	0.30	0.19
	Air	with Grid	0.30	0.17		0.38	Yes	No	No
	Argon	no Grid	0.27	0.18		0.43	Yes	Yes	No
	Argon	with Grid	0.27	0.17		0.38	Yes	Yes	No

AWNING	Glass Type Exterior + Interior	Gap Fill	Grid Option	NFRC Performance Ratings			EnergyStar® v7 Climate Zone Compliance		
				U-F	SHGC	VT	Southern	S.Central	N.Central
				Standard	LoE-366 + Clear	Air	no Grid	0.30	0.19
	Air	with Grid	0.30	0.17		0.38	Yes	No	No
	Argon	no Grid	0.27	0.18		0.43	Yes	Yes	No
	Argon	with Grid	0.27	0.17		0.38	Yes	Yes	No

PICTURE WINDOW	Glass Type Exterior + Interior	Gap Fill	Grid Option	NFRC Performance Ratings			EnergyStar® v7 Climate Zone Compliance		
				U-F	SHGC	VT	Southern	S.Central	N.Central
				Standard	LoE-366 + Clear	Air	no Grid	0.29	0.22
	Air	with Grid	0.29	0.20		0.45	Yes	No	No
	Argon	no Grid	0.26	0.21		0.51	Yes	Yes	No
	Argon	with Grid	0.26	0.19		0.45	Yes	Yes	No

Unless specified, the NFRC values & Energy Star compliance are for double glazed, SSB (3/32") glass thickness. For glass thicknesses above this, contact your sales representative for ratings information.

Please visit WestlakeRoyalWindows.com for more Energy Star options.

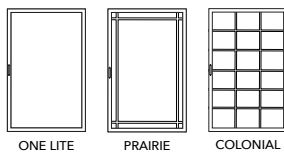

CARDINAL IG

You may qualify for a tax credit when you replace your existing windows. For more information, go to energystar.gov



Westlake
Royal Window Solutions™

Legacy Collection
250 Series Black/Black – New Construction



- All welded frame and sash
- Integral nail fin
- Aesthetically pleasing exterior frame design
- Intermediate jamb for continuous head and sill products
- Vinyl is coextruded acrylic cap for superior color hold, weathering, and durability
- Exterior glazed equal and unequal sash
- Optimum designed aluminum sash reinforcement
- Multi-chambered vinyl profiles for thermal efficiency
- Dual weatherstripping
- DP 35 performance levels
- Full family of products: hung, slider, and picture windows

Legacy Collection **250 Series Black/Black – New Construction**



NFRC PERFORMANCE RATINGS
(3/4" overall IG with Quanex Duralite spacer)

SINGLE HUNG	Glass Type Exterior + Interior	Gap Fill	Grid Option	NFRC Performance Ratings			EnergyStar® v7 Climate Zone Compliance		
				U-F	SHGC	VT	Southern	S.Central	N.Central
				Standard	LoE-366 + Clear	Air	no Grid	0.33	0.23
	Air	with Grid	0.33	0.21		0.47	No	No	No
	Argon	no Grid	0.29	0.23		0.53	Yes	No	No
	Argon	with Grid	0.29	0.20		0.47	Yes	No	No

PICTURE WINDOW	Glass Type Exterior + Interior	Gap Fill	Grid Option	NFRC Performance Ratings			EnergyStar® v7 Climate Zone Compliance		
				U-F	SHGC	VT	Southern	S.Central	N.Central
				Standard	LoE-366 + Clear	Air	no Grid	0.30	0.25
	Air	with Grid	0.30	0.23		0.52	Yes	No	No
	Argon	no Grid	0.26	0.24		0.58	No	No	No
	Argon	with Grid	0.26	0.22		0.52	Yes	Yes	No

HORIZONTAL SLIDER	Glass Type Exterior + Interior	Gap Fill	Grid Option	NFRC Performance Ratings			EnergyStar® v7 Climate Zone Compliance		
				U-F	SHGC	VT	Southern	S.Central	N.Central
				Standard	LoE-366 + Clear	Air	no Grid	0.33	0.23
	Air	with Grid	0.33	0.21		0.47	No	No	No
	Argon	no Grid	0.29	0.23		0.53	Yes	No	No
	Argon	with Grid	0.29	0.20		0.47	Yes	No	No

Unless specified, the NFRC values & Energy Star® compliance are for double glazed, SSB (3/32") glass thickness. For glass thicknesses above this, contact your sales representative for ratings information.

Please visit WestlakeRoyalWindows.com for more Energy Star options.

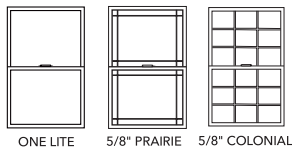

You may qualify for a tax credit when you replace your existing windows. For more information, go to energystar.gov



Westlake
Royal Window Solutions™

Krestmark® Collection
400 Series – New Construction



The 400 Series Window is primarily a new construction window but should not be ruled out for remodeling or replacement applications. Available in Single Hung, Horizontal Slider, Picture Window, architectural shapes and mulled units.

- Multi-chambered extruded vinyl frame and sash provide stability with excellent strength, thermal-resistant properties and is extremely low maintenance.
- Integral pre-punched nail fin adds strength, is a weathertight barrier and provides ease of installation.
- Fusion-welded corners in frame and sash provide strength and virtually eliminates air and water infiltration.
- Dual pane 3/4" insulated glass with environmentally friendly Warm Edge Spacer reduces thermal loss (type may vary).
- All picture windows, shapes and one-frame glass larger than 30 square feet will come with Tempered Glass as standard for safety reasons. All additional charges for Tempered Glass will automatically be applied.

Krestmark® Collection

400 Series – New Construction



Argon-enhanced glass improves energy efficiency.

E66 is a light green tint and provides the most efficient U-Factor & SHGC.

Tempered, obscure, bronze or grey glass.

Factory muller or stacked units and field mull accessories.

Impact available for coastal areas, added security or sound dampening (See Series 4000).

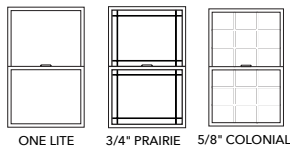

ONE LITE 3/4" PRAIRIE 5/8" COLONIAL



SIMULATED DIVIDED LITE



GRILLE BETWEEN GLASS



WHITE



SANDSTONE



CLAY

CARDINAL IG

NFRC PERFORMANCE RATINGS

(3/4" overall IG with Quanex Duralite spacer)

SINGLE HUNG	Glass Type Exterior + Interior	Gap Fill	Grid Option	NFRC Performance Ratings			EnergyStar® v7 Climate Zone Compliance			
				U-F	SHGC	VT	Southern	S.Central	N.Central	
Standard	LoE-366 + Clear	Air	no Grid	0.32	0.23	0.54	Yes	No	No	
			with Grid	0.32	0.21	0.48	Yes	No	No	
			Argon	no Grid	0.28	0.23	0.54	Yes	Yes	No
IMPACT rated (Missile-D) Requires DSB + 6.9L glass	LoE-366 + Clear	Air	no Grid	0.34	0.23	0.53	No	No	No	
			with Grid	0.35	0.21	0.48	No	No	No	
			Argon	no Grid	0.29	0.23	0.53	Yes	No	No
STC rated (STC = 32) requires DSB + 3/16" glass thickness & 11/16" IG	LoE-366 + Clear	Air	no Grid	0.34	0.24	0.53	No	No	No	
			with Grid	0.35	0.21	0.48	No	No	No	
			Argon	no Grid	0.29	0.23	0.53	Yes	No	No
			Argon	with Grid	0.30	0.21	0.48	Yes	No	No

HORIZONTAL SLIDER	Glass Type Exterior + Interior	Gap Fill	Grid Option	NFRC Performance Ratings			EnergyStar® v7 Climate Zone Compliance			
				U-F	SHGC	VT	Southern	S.Central	N.Central	
Standard	LoE-366 + Clear	Air	no Grid	0.32	0.23	0.54	Yes	No	No	
			with Grid	0.32	0.21	0.48	Yes	No	No	
			Argon	no Grid	0.29	0.23	0.54	Yes	No	No
IMPACT rated (Missile-D) Requires DSB + 6.9L glass	LoE-366 + Clear	Air	no Grid	0.34	0.23	0.53	No	No	No	
			with Grid	0.35	0.21	0.48	No	No	No	
			Argon	no Grid	0.29	0.23	0.53	Yes	No	No
			Argon	with Grid	0.30	0.21	0.48	Yes	No	No

PICTURE WINDOW	Glass Type Exterior + Interior	Gap Fill	Grid Option	NFRC Performance Ratings			EnergyStar® v7 Climate Zone Compliance			
				U-F	SHGC	VT	Southern	S.Central	N.Central	
Standard	LoE-366 + Clear	Air	no Grid	0.30	0.25	0.59	No	No	No	
			with Grid	0.30	0.23	0.53	Yes	No	No	
			Argon	no Grid	0.26	0.25	0.59	No	No	No
IMPACT rated (Missile-D) Requires 3/16" + 8.6L glass	LoE-366 + Clear	Air	no Grid	0.39	0.26	0.56	No	No	No	
			with Grid	0.43	0.24	0.51	No	No	No	
			Argon	no Grid	0.33	0.26	0.56	No	No	No
STC rated (STC = 30) requires DSB + 3/16" glass thickness	LoE-366 + Clear	Air	no Grid	0.30	0.25	0.58	No	No	No	
			with Grid	0.30	0.23	0.52	Yes	No	No	
			Argon	no Grid	0.26	0.25	0.58	No	No	No
			Argon	with Grid	0.26	0.23	0.52	Yes	Yes	No

Unless specified, the NFRC values & Energy Star compliance are for double glazed, SSB (3/32") glass thickness. For glass thicknesses above this, contact your sales representative for ratings information.

It is recommended not to mix LoE-360 with LoE-366 products within the same building structure since the inward and outward color/shade appearances are noticeably different.

Please visit WestlakeRoyalWindows.com for more Energy Star options.

You may qualify for a tax credit when you replace your existing windows. For more information, go to energystar.gov



Westlake
Royal Window Solutions™

Krestmark® Collection
220 Series – Replacement



The Vinyl Replacement Window 220 is offered with a LoE glass option. LoE high performance glass with argon gas allows light to filter in while keeping the sun's harmful rays out. In addition, this special glazing saves energy and reduces utility costs by keeping the cool air inside in the summer and the warm air inside in the winter.

Note: All picture windows, shapes and one-frame glass larger than 30 square feet will come with Tempered Glass as standard for safety reasons. All additional charges for Tempered Glass will automatically be applied.

- 3" main frame beveled exterior profile gives an outstanding, bold appearance.
- Tilt-in sash for easy cleaning.
- Block and tackle balance system for long-lasting, smooth, quiet operation.
- 3/4" LoE E66 Environsealed Windows™, environmentally friendly with warm-edge spacer reduces thermal loss. Type and look of warm-edge spacer may vary.
- Ventilation control for opening windows only 4".
- Metal-reinforced center bar for better structural performance and weather tightness.
- Multi-chambered design for structural integrity, superior thermal performance, maintenance-free, vinyl frame and sash extrusions.
- Argon-enhanced glass improves energy efficiency.
- The Replacement 220 is available with an integral nail fin.
- Tempered glass, rain glass, obscure glass.
- Factory mulls (combined units) with continuous head and sill.

Krestmark® Collection

220 Series – Replacement

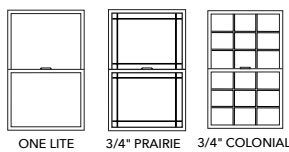

CARDINAL IG

NFRC PERFORMANCE RATINGS (3/4" overall IG with Qualex Duralite spacer)

	Glass Type Exterior + Interior	Gap Fill	Grid Option	NFRC Performance Ratings			EnergyStar® v7 Climate Zone Compliance		
				U-F	SHGC	VT	Southern	S.Central	N.Central
Standard	LoE-366 + Clear	Air	no Grid	0.33	0.22	0.51	No	No	No
			with Grid	0.33	0.20	0.46	No	No	No
		Argon	no Grid	0.30	0.22	0.51	Yes	No	No
			with Grid	0.30	0.20	0.46	Yes	No	No
STC rated (STC = 29) requires DSB + 3/16" glass thickness	LoE-366 + Clear	Air	no Grid	0.33	0.22	0.50	No	No	No
			with Grid	0.33	0.20	0.45	No	No	No
		Argon	no Grid	0.29	0.22	0.50	Yes	No	No
			with Grid	0.29	0.20	0.45	Yes	No	No

	Glass Type Exterior + Interior	Gap Fill	Grid Option	NFRC Performance Ratings			EnergyStar® v7 Climate Zone Compliance		
				U-F	SHGC	VT	Southern	S.Central	N.Central
Standard	LoE-366 + Clear	Air	no Grid	0.32	0.23	0.54	Yes	No	No
			with Grid	0.32	0.21	0.49	Yes	No	No
		Argon	no Grid	0.28	0.23	0.54	Yes	Yes	No
			with Grid	0.28	0.21	0.49	Yes	Yes	No
STC rated (STC = 31) requires DSB + 3/16" glass thickness & 11/16" IG	LoE-366 + Clear	Air	no Grid	0.34	0.24	0.53	No	No	No
			with Grid	0.36	0.22	0.48	No	No	No
		Argon	no Grid	0.29	0.23	0.53	Yes	No	No
			with Grid	0.30	0.21	0.48	Yes	No	No

	Glass Type Exterior + Interior	Gap Fill	Grid Option	NFRC Performance Ratings			EnergyStar® v7 Climate Zone Compliance		
				U-F	SHGC	VT	Southern	S.Central	N.Central
Standard	LoE-366 + Clear	Air	no Grid	0.33	0.22	0.51	No	No	No
			with Grid	0.33	0.20	0.46	No	No	No
		Argon	no Grid	0.29	0.22	0.51	Yes	No	No
			with Grid	0.29	0.20	0.46	Yes	No	No
STC rated (STC = 29) requires DSB + 3/16" glass thickness & 11/16" IG	LoE-366 + Clear	Air	no Grid	0.34	0.22	0.51	No	No	No
			with Grid	0.35	0.20	0.45	No	No	No
		Argon	no Grid	0.29	0.22	0.51	Yes	No	No
			with Grid	0.30	0.20	0.45	Yes	No	No

Unless specified, the NFRC values & Energy Star compliance are for double glazed, SSB (3/32") glass thickness. For glass thicknesses above this, contact your sales representative for ratings information.

Please visit WestlakeRoyalWindows.com for more Energy Star options.

You may qualify for a tax credit when you replace your existing windows. For more information, go to energystar.gov







BUILDER SERIES

W I N D O W S



4810 SINGLE HUNG



MORE VALUE. MORE PERFORMANCE. MORE SOLUTIONS.

If you're looking for a window that delivers the best possible performance at the best possible value, look no further than Ply Gem Windows Builder Series. It's energy-efficient and offers a variety of material choices, most of which are virtually maintenance free and can withstand the toughest tests, including the test of time. Plus, with our service and support you'll be able to get the job done the right way on time and on budget.

windows.plygem.com

4800 THERMAL BREAK ALUMINUM



4810 SERIES SINGLE HUNG



STANDARD FEATURES

- Thermally broken aluminum frame with polyurethane poured in place and debridged to reduce thermal conductivity of aluminum frame
- Virtually maintenance-free extruded aluminum construction with electrostatically applied finish
- Sloped sill allows for proper water drainage to the exterior
- Sleek profile provides larger viewing area
- Interior glazing allows for easier glass replacement
- Side load removable bottom sash
- Block and tackle balance system
- Energy-efficient Warm Edge insulating glass
- Structural meeting rail provides rigid stability and allows for a tighter, weather-resistant unit
- Dual lift rails on bottom sash for easy operation
- Frame depth available in 2 7/16"
- Integral nailing fin with a 1 3/8" setback for simple installation



4810 SERIES THERMAL PERFORMANCE

	R Value	NFRC CERTIFIED		
		U Factor	SHGC	VT
WARM EDGE				
3/4" IGU Clear	1.61	0.62	0.65	0.67
3/4" IGU Low E	2.08	0.48	0.31	0.57
3/4" IGU Low E ^{SC}	2.13	0.47	0.24	0.44
3/4" IGU Low E 2+	2.33	0.43	0.30	0.55
3/4" IGU Low E ^{SC} 2+	2.33	0.43	0.23	0.43
3/4" IGU HP	2.27	0.44	0.31	0.57
3/4" IGU HP ^{SC}	2.27	0.44	0.24	0.44
3/4" IGU HP 2+	2.50	0.40	0.30	0.55
3/4" IGU HP ^{SC} 2+	2.50	0.40	0.23	0.43
WARM EDGE				
3/4" IGU Low E	2.13	0.47	0.31	0.57
3/4" IGU Low E ^{SC}	2.13	0.47	0.24	0.44
3/4" IGU Low E 2+	2.38	0.42	0.30	0.55
3/4" IGU Low E ^{SC} 2+	2.38	0.42	0.23	0.43
3/4" IGU HP	2.27	0.44	0.31	0.57
3/4" IGU HP ^{SC}	2.33	0.43	0.24	0.44
3/4" IGU HP 2+	2.50	0.40	0.30	0.55
3/4" IGU HP ^{SC} 2+	2.50	0.40	0.23	0.43

All units are NAMI certified and rated in accordance with NFRC 100/200 standards by an AAMA accredited lab. Performance values reflect the performance of units tested with the following configuration: 3/4" IGU, 3mm glass and no grilles.

R VALUE: Restrictive ambient air flow; U FACTOR: Rate of heat loss; SHGC: Solar Heat Gain Coefficient; VT: Visible Transmittance

OPTIONS

GLASS OPTIONS:

Low-E, Low-E^{SC}, Low-E2+, Low-E^{SC}2+, HP, HP^{SC}, HP2+, HP^{SC}2+, obscure and tempered

GRILLE OPTIONS:

Color-coordinated grilles-between-the-glass (GBG) in 5/8", 3/4" flat and 1-3/16" SDL with shadow bar

PRODUCT CONFIGURATION:

Matching side lites, fixed panels, transoms, segmented transoms and a wide selection of architectural shapes

HARDWARE OPTION:

Safety vent latch to meet ASTM F2090-2008 requirements

COLOR OPTIONS:

WHITE

BRONZE

BLACK

NOTE: Colors shown are close approximations and may not be accurate representations for color matching. Please request color swatches from your Ply Gem sales representative to do so.



1. Low E glass options available including solar cooling glass for warm climates.
2. Optional HP glass combines Low-E with argon gas fill for high performance. HP options include solar cooling and inside surface Low-E options.
3. Impact Rated units are available in select sizes and configurations.





TectView™ Ex



TectView Ex

Max Sizes:

- Single Hung (Shown)
54" x 120"
- Double Hung
48" x 84"
- Single Slider
96" x 66"
- End Vent Slider
120" x 66"
- Picture Window
60" x 120"

STANDARD FEATURES

- 3 ¼" jamb depth
- Light Commercial rating and DP 50 available in Single Hung, Single Slider and Picture Window (Specify when ordering)
- Equal site lines on all operating windows
- Superior styling for the look of wood without the maintenance
- Integral J-channel for siding applications and superior frame strength
- Exterior glazing on all EX windows
- ¾" Caldwell adjustable stainless steel balance system

OPTIONS

- Sash Limiting Devices
- Can upgrade to 1" insulated glass units
- Full or half screens available on all windows
- Full screen track on picture windows for optional solar screens
- Laminated and triple pane glass available



TectView™ Ac

TectView Ac

Max Sizes:

Single Hung (Shown)

48" x 96"

Single Slider

72" x 60"

End Vent Slider

120" x 60"

Picture Window

60" x 84"



STANDARD FEATURES

- 2 7/8" jamb depth
- Operating or fixed extended round windows as narrow as 23 1/2"
- Fiberglass half screen on all operating windows standard
- 1/2" Caldwell adjustable stainless steel balance system
- Slimmer profile for more visible glass
- Equal site lines on all operating windows
- 2 locks on all windows wider than 23 1/4" wide
- Reinforced center bars

OPTIONS

- Sash Limiting Devices



TectView™ Ca



TectView Ca

Max Sizes:

Casement (Shown)

36" x 80"

Fixed Casement

72" x 72"

Awning

60" x 36"

TectView Pd

Max Sizes:

2 panel sliding door

(Shown) 96" x 96"

3 panel sliding door

120" x 96"

Fixed sidelite

48" x 96"

STANDARD FEATURES

- 3 ¼" jamb depth
- Casement, Fixed Casement and Awning utilize the same frame for equal glass in combination units and uniform appearance
- Truth Hardware and folding handles on all operable units
- Stainless steel hardware available for coastal applications



TectView™ Pd

STANDARD FEATURES

- Stainless steel mortice lock keepers
- 4 7/8" jamb depth
- Industry leading Amesbury Hardware
- Exterior Key lock standard
- Precision sealed bearings on rollers for a lifetime of smooth operation
- Aluminum roller track
- Color matched threshold
- Steel reinforcement in meeting rail, sash stile, and mortice lock frame side.
- DP50 in new construction and replacement up to 96" x 82" two panel doors.
- 3 panel door and sidelites available

OPTIONS

- Impact resistant 2 panel door to 96" x 82" in new construction or replacement installation.
- 3 panel door available in XOO, OXO, AND OOX
- Transoms and sidelites available in matching frame



PRODUCT DETAILS



We can custom manufacture any kind of window you need, whether you want windows for a new construction project or to replace the windows in your existing home. Our offerings include single-hung, double-hung, slider, casement, picture and geometric shapes.

Replacements

Our Replacement windows are made in 1/8" increments to ensure a more custom fit for the homeowner. In the end, we'll make sure your windows fit precisely and securely, so you can be absolutely confident in your Burris windows.

Window Styles Options

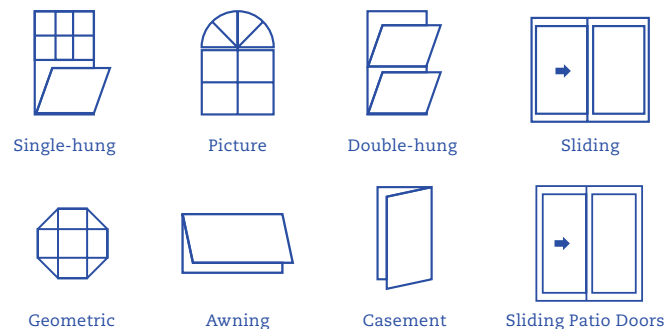

Obscure Glass Options

Burris Windows offers many different styles of obscure glass, which can be used to decoratively separate spaces, yet allow light to pass through. Whether you are trying to decorate an office or conference room door, front door of your home, or an exterior bathroom window we have the right obscure glass for you.

Divided lite options between the glass – standard 5/8" wide flat grid, 1" wide contour grids. 1 1/8" wide simulated divided lites are available on the exterior of the glass.

Quality is Standard

ALL OUR WINDOWS COME STANDARD WITH:

- Double strength glass, Cardinal Lowe 270 and Argon. We also offer Cardinal Lowe 366, for more information on our glass see our website or go to: www.cardinalcorp.com.
- Factory or Field mullions available on all windows and doors.
- Industry Leading Caldwell Stainless Steel Adjustable Constant force balance system on all single and double hungs.
- Extruded interlock in sash and meeting rail of all single hung, double hung and sliding windows.
- Aluminum reinforced meeting rail and lock rail in all single hung, double hung and sliders.

Colors

All Burris windows and doors available in the three colors white, tan and clay with color-matched hardware.



Efficiency

All Burris Windows can be ordered to meet ENERGY STAR® requirements in all 50 states.



WINDOR SYSTEMS

2750 FOLDING WINDOW



WINDOR® SYSTEMS

For the Name and the Products You Should Trust!



2750 Bi-Folding Window System



Features and Benefits

- Vinyl Frame with aluminum reinforcement
- Foam backed seal on main frame
- Contemporary style vinyl sash
- Welded sash corners
- Dual interlocking weather seal on sash for superior air and thermal performance
- Centor™ E3 hardware system in stainless and dark powder coat finishes
- Stainless multipoint locking hardware
- Internal Multipoint shoot bolt system

Glass Options

- Cardinal™ 366® LoE Dual Glaze tempered with warm edge spacer system
- Clear, obscure, and custom glass is available

Hardware

- Hardware Colors; White, Black powder coat, and Brushed Chrome

Grids

- SDL (Simulated Divided Lite)
- Flat (Colonial)
- Sculptured (Continental)

Sizes

- New Construction / Replacement Custom applications



Drawings show out-swing operation

AVAILABLE THROUGH



Win-Dor is a proud member of the following

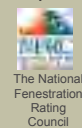

www.windorsystems.com





SIMONTON[®]
WINDOWS & DOORS

StormBreaker Plus®

PREMIUM VINYL COASTAL WINDOWS



IMPACT ZONE CERTIFIED
MISSILE D & HVHZ



IMPRESSIVE INSIDE & OUT



Tested and Certified for Coastal Living.



HVHZ Certified

HVHZ CERTIFIED

Select window and patio door sizes are certified for High-Velocity Hurricane Zones (HVHZ), meeting the highest impact standards set by the Florida Building Commission for Miami-Dade and Broward County.



Missile D Certified

MISSILE D CERTIFIED

Meets Missile D impact specifications for the Florida Building Commission and the Texas Department of Insurance evaluation for the Texas Coast.



SCAN TO SEE SIMONTON IMPACT TESTING THAT SUBJECTS OUR WINDOWS AND PATIO DOORS TO SEVERE HURRICANE CONDITIONS.

* StormBreaker Plus windows and patio doors have SafePoint Max or Max+ impact-resistant glass required for your certification level, style and product size.



The Strength is in the Design.

Simonton StormBreaker Plus® windows deliver the coastal performance your home requires, along with essential features that enhance your home's comfort, aesthetics and convenience.

SIMONTON STORMBREAKER PLUS DOUBLE HUNG

1. BUILT-IN STRENGTH

Fusion-welded frame and sash increase weather resistance and durability, while the reinforced profiles add to the window's structural integrity.

2. BEAUTIFUL DESIGN

Timeless beveled frame design complements any home.

3. STORM PROTECTION

SafePoint® Max impact-resistant laminated glass protects against high winds and windborne debris.*

4. ENERGY EFFICIENT

1" insulating glass unit with ProSolar® Low-E glass and Argon gas increases efficiency and comfort.

5. LONG-LASTING BEAUTY

The vinyl color is molded throughout the profile for long-lasting beauty that withstands coastal conditions that won't rot, deteriorate, pit or peel like wood or aluminum windows.

6. WATER BARRIER

Triple-stepped, sloped Simonton Sill® and Lap Lok® meeting rail on Double Hung windows protect against wind and rain.

7. TROUBLE-FREE OPERATION

The stainless-steel constant force coil spring balance system easily raises and lowers the sash.



* StormBreaker Plus windows have SafePoint Max or Max+ impact-resistant glass required for certification level and product size.

Select Your Design Options.

Bring your vision to life with a variety of colors and hardware options to complete the aesthetic of your home. StormBreaker Plus® windows and doors are built with virtually maintenance-free vinyl that provides long-lasting beauty and withstands harsh coastal conditions.

INTERIOR/EXTERIOR VINYL COLORS



White



Tan

CUSTOM EXTERIOR FINISHES



Bronze

HARDWARE FINISHES



White



White



Tan



Tan



Brass



Brass



Dark Bronze
(Patio Door only)

Due to limitations in the printing process, actual colors may vary from printed materials. Please see a sample of the product before making your final color selection.



Sunroom

WELCOME TO YOUR NEW FAVORITE ROOM.



WHY SIMONTON WINDOWS FOR YOUR SUNROOM?

- A sunroom built with Simonton windows offers a quiet, comfortable, energy-efficient haven you can use year-round.
- Simonton windows are remarkably durable and they're more affordable than acrylic.
- Simonton windows are easy to install in 2", 3" or 4" aluminum frames.
- Ordinary glass cleaner is all it takes to keep Simonton windows crystal clear.



Sunroom



A ROOM IS BORN.

Transform your porch, patio or other outdoor living space into an inviting, sun-filled room that you'll enjoy all year long. Simonton windows are the perfect choice for a sunroom that provides maximum enjoyment season after season. A generous selection of styles and sizes allows you to choose the windows that will complement your home beautifully.

Contact your Simonton representative to learn more.



Simonton ProFinish[®] Contractor Series

- **Premium vinyl construction** is virtually maintenance-free.
- A sleek, 2 7/8" **narrow frame** provides an attractive, streamlined appearance.
- An exclusive **Lap-Lok[®] meeting rail** overlaps and interlocks the sash to virtually eliminate air and water infiltration.
- The **extruded lift rail** is easy to grasp and remarkably durable.
- The **sloped sill design** forces water away from the window quickly.
- A **20-year Limited Warranty** covers screens, hardware and glass. Vinyl is covered by a **Lifetime Limited Warranty**.
- **Easy to install** in 2" or 3" aluminum frames.



ProSolar[®] Low E glass with an Argon gas fill provides great energy efficiency while helping to retain cooled air in warmer months.

Styles

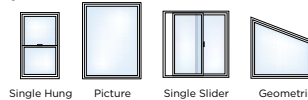

Simonton Reflections[®] 5500 Series

- **Premium vinyl construction** requires virtually no maintenance.
- A classic 3 1/4" frame is as **durable** as it is beautiful.
- An exclusive **Lap-Lok[®] meeting rail** overlaps and interlocks the sash to virtually eliminate air and water infiltration.
- The **extruded pull stile** is easy to grasp and won't loosen or break off over time.
- A **Double Lifetime Limited Warranty** includes vinyl, hardware, screens and glass.
- **Easy to install** in 3" or 4" aluminum frames.



Our most advanced Low E glass, optional **ProSolar[®] Shade** is a spectrally selective glass that blocks damaging UV rays while allowing desirable light into the home. The unique formula with three layers of silver helps provide solar heat control, fade protection, visibility and energy savings.



Styles

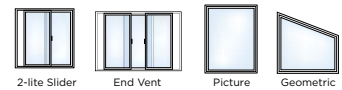

SIMONTON HAS TAKEN THE GUESSWORK OUT OF GLASS.



Order Simonton's regionally specific ENERGY STAR[®] glass packages to meet the guidelines for the Southern and South-Central regions.



ENERGY STAR Regions

- South-Central
- Southern



VELUX®



The VELUX Skylight System

The Ultimate Skylight Experience



Skylight System

Our Best Skylight Is Now Even Better

- ① **Glass Skylight**
The base of the VELUX Skylight System is our world-famous skylight! With multiple installation options, the skylight can be fixed or venting to provide fresh air. Venting models are available in solar-powered (pictured below), electric, and manual operations.
- ② **Solar-Powered Shade**
The included room-darkening skylight shade is solar-powered and offers total light control, increasing the Skylight System's energy performance up to 45%*.
*Actual percentage varies by skylight model and size
- ③ **Remote Controls**
Each shade included in a Skylight System comes with a factory-paired remote control for easy set-up and operation. Electric and solar venting Skylight Systems also include a pre-paired remote to open and close the skylight.
Manual venting Skylight Systems can be operated with a handle or control rod, sold separately. See all remote options on page 17.
- ④ **Standard Safety Glass**
Our Standard Safety Glass is a laminated glass for added protection in out-of-reach areas and includes a 10-year hail warranty for peace of mind. Its double-pane, argon-filled design reduces outside noise while providing a clear view of the sky.
- ⑤ **Rain Sensors**
Each solar and electric venting Skylight System features an integrated rain sensor to close the skylight automatically at the first signs of inclement weather.
- ⑥ **Insect Screens**
Every venting Skylight System includes an insect screen to prevent bugs and debris from entering the home through an open skylight.
- ⑦ **Weathertight Guarantee**
VELUX flashing is required to create a weathertight seal around deck- and curb-mount Skylight Systems, as well as to qualify for our 10-year installation warranty.

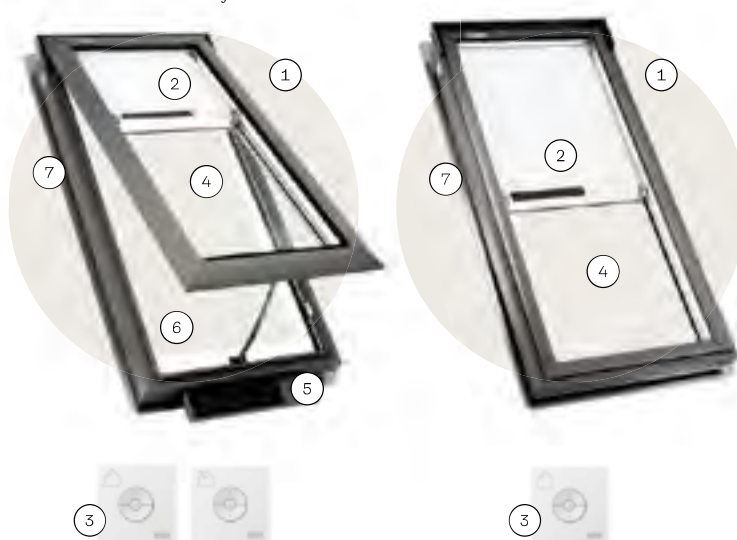

VELUX SKYLIGHT SYSTEM

Skylight + Shade + Remote

Why Skylight Shades?

Your skylight wants shades.

It's simple: a skylight isn't complete without a shade! VELUX skylights have always provided abundant natural light, and now it's our standard that they also provide light control. Not only does this create a better overall experience, adding shades to skylights also improves their energy efficiency and helps create an overall more sustainable home.

Skylight Shade Benefits

How shades improve the System.

- **Light Control:** Easily open and close shades with a remote control to let in light or prevent glare on your terms.
- **Climate Control:** Shades help better insulate the skylight, blocking heat gain in the summer and keeping heat in during the winter.
- **Energy Efficiency:** VELUX solar-powered shades can increase a skylight's energy efficiency up to 45%¹ while natural light allows you to rely less on electricity.

More Skylight System Benefits

Other ways the System works for you.

- **Easy Installation:** Everything your installer needs to install your skylight system is ready to go when they arrive at your home, helping cut down on project time and the need for follow-up fixes.
- **Quality You Trust:** VELUX has been the world-leader in skylights and roof windows for over 80 years, and we're using that expertise to make your daylighting experience even better than before.



**VELUX
SKYLIGHT
SYSTEM**

Skylight + Shade + Remote

Deck-Mounted Skylight Systems

Explore our range of classic deck-mounted skylights with shades, including solar, electric, and manual versions. Deck-mounted skylights attach directly to your roof with no need for a curb, resulting in a quick, seamless, and watertight installation.

VIEW FULL BROCHURE



DECK-MOUNTED SKYLIGHT SYSTEM

Deck-Mounted Skylight Systems



VSS

A B C D E

Solar-Powered Fresh Air Skylight System

- Powered by a discreet solar panel allowing you to open and close your skylight with the touch of a button without using your home's electricity
- Equipped with a built-in rain sensor to close the unit in the event of inclement weather



VSE

A B C D E

Electric Fresh Air Skylight System

- Concealed motor and control system easily opens and closes skylight with a remote
- Equipped with a built-in rain sensor to close the unit in the event of inclement weather



VS

A C D E

Manual Fresh Air Skylight System

- Opens and closes by hand with a smooth turning handle for in-reach applications and a rod for out-of-reach ones
- Choose from a variety of different glass types, such as impact or snowload



FS

A C E

Fixed Skylight System

- Designed to visually expand a space by bringing in an abundance of natural light
- Choose between a variety of different glass types, such as impact or snowload
- Low-profile creates a clean, streamlined appearance on the roof

Optional Upgrades: Impact Glass¹ | Snowload Glass² | Copper Cladding³ | Stain Grade Wood Interior⁴

¹ FS C04, C06, M06, M08, and S06 sizes stocked. Other standard sizes, excluding C12, available as special order. ² Special Order for all standard sizes. ³ Excluding VSS. ⁴ VSS, VS, FS sizes C04, C06, M06, M08, S06 stocked. VSE available as Special Order.

A Add the VELUX App Control system, Gateway + App:
Automate operation of your VELUX venting skylights and shades to match your schedule anytime, anywhere with your smartphone or smart home device. See page 17



B Add VELUX ACTIVE:
Improve indoor air quality and climate based on temperature, humidity, and CO₂ levels with smart sensor automation of your VELUX skylights and shades. See page 17



C Wireless remote included. **D** Equipped with insect screen. **E** 10-year installation warranty when installed with VELUX Flashing, see page 25.

Standard Sizes	A06	C01	C04	C06	C08	C12	D26	D06	M02	M04	M06	M08	S01	S06
Rough Opening (W ⁱⁿ .xH ⁱⁿ)	14 1/2 x 45 3/4	21 x 26 7/8	21 x 37 7/8	21 x 45 3/4	21 x 54 7/16	21 x 70 1/4	22 1/2 x 22 15/16	22 1/2 x 45 3/4	30 1/16 x 30	30 1/16 x 37 7/8	30 1/16 x 45 3/4	30 1/16 x 54 7/16	44 1/4 x 26 7/8	44 1/4 x 45 3/4
VSS Solar / VSE Electric		•	•	•	•				• ¹	•	•	•	•	•
VS Manual		•	•	•	•				•	•	•	•	•	•
FS Fixed	•	•	•	•	•	•	♦	♦	•	•	•	•	•	•

Unless noted, all base models include pre-installed room-darkening, double pleated white shade. ♦ Model FS sizes D26 and D06 fit perfectly between roof trusses.

**VELUX
SKYLIGHT
SYSTEM**

Skylight + Shade + Remote

Curb-Mounted Skylight Systems

Our curb-mounted skylights with integrated shades make it easy to enjoy fresh air and daylight—even with flat or low-pitched roofs. Designed to fit over a site-built curb using standard lumber, they're compatible with a variety of roofing materials from shingles to tile.

VIEW FULL BROCHURE



CURB-MOUNTED SKYLIGHT SYSTEM

Curb-Mounted Skylight Systems



VCS

A B C D E

Solar-Powered Fresh Air Skylight System

- Solar-powered battery control system easily opens and closes skylight with remote or smartphone app
- Equipped with a built-in rain sensor to close the unit at the first sign of rain

VCE

A B C D E

Electric Fresh Air Skylight System

- Concealed motor and control system easily opens and closes skylight with a remote
- Rain sensor automatically closes skylight at the first sign of rain

VCM

A C D E

Manual Fresh Air Skylight System

- Manually open and close the skylight with smooth-turning handles or control rods
- White frames and sashes create a sleek, high quality finish

FCM

A C E

Fixed Skylight System

- Low profile creates a clean, streamlined appearance on the roof
- Positioning allows for twice the natural light as vertical windows
- Custom sizes available

Optional Upgrades: Impact Glass¹ | White Laminated Glass² | Triple Pane Glass³

¹ Excluding VCE. VCS 2222, 2246 stocked. FCM sizes 2222, 2234, 2246, 3030, 3046, 3434, 4646 stocked. Excluding FCM sizes 2270, 3055, 4672. ² Excluding VCE.

³ Available only for FCM as Special Order in standard sizes, excluding 2270, 3055, 3171, 4672. FCM with Triple Pane Glass cannot accommodate a solar shade.

A Add the VELUX App Control system, see page 17. **B** Add VELUX ACTIVE, see page 17. **C** Wireless remote included.

D Equipped with insect screen. **E** 10-year installation warranty when installed with VELUX Flashing, see page 25.

Standard Sizes	1430*	1446*	1943	2222	2230	2234	2246	2270	2347	3030	3046
Outside Curb (W-in. x H-in.)	17 1/2 x 33 1/2	17 1/2 x 49 1/2	22 1/2 x 46 1/2	25 1/2 x 25 1/2	25 1/2 x 33 1/2	25 1/2 x 37 1/2	25 1/2 x 49 1/2	25 1/2 x 73 1/2	26 1/2 x 50 1/2	33 1/2 x 33 1/2	33 1/2 x 49 1/2
Max Skylight Clearance (W-in. x H-in.)	18 5/8 x 34 5/8	18 5/8 x 50 5/8	23 1/8 x 47 5/8	26 5/8 x 26 5/8	26 5/8 x 34 5/8	26 5/8 x 38 5/8	26 5/8 x 50 5/8	26 5/8 x 74 5/8	27 5/8 x 51 5/8	34 5/8 x 34 5/8	34 5/8 x 50 5/8
VCS Solar				•		•	•			•	•
VCE Electric				•		•	•			•	•
VCM Manual				•		•	•			•	•
FCM Fixed	•	•	•	•	•	•	•	•	•	•	•

Standard Sizes (cont.)	3055	3171	3422	3434	3446	3737	4622	4630	4646	4672
Outside Curb (W-in. x H-in.)	33 1/2 x 58 1/2	35 x 75	37 1/2 x 22 1/2	37 1/2 x 37 1/2	37 1/2 x 49 1/2	40 1/2 x 40 1/2	49 1/2 x 25 1/2	49 1/2 x 33 1/2	49 1/2 x 49 1/2	49 1/2 x 75 1/2
Max Skylight Clearance (W-in. x H-in.)	34 5/8 x 59 5/8	36 1/8 x 76 1/8	38 5/8 x 26 5/8	38 5/8 x 38 5/8	38 5/8 x 50 5/8	41 5/8 x 41 5/8	50 5/8 x 26 5/8	50 5/8 x 34 5/8	50 5/8 x 50 5/8	50 5/8 x 76 5/8
VCS Solar				•		•	•	•	•	
VCE Electric				•					•	
VCM Manual				•					•	
FCM Fixed	•	•	•	•	•		•	•	•	•

*Shades are not available for FCM sizes 1430 or 1446.



See More
Flat Roof Models:
[Curb-Mounted
Skylights](#)
Page 9
[Sun Tunnel®
Skylights](#)
Page 21

Flat Roof Skylights

Designed for homes with flat or low-slope roofs, VELUX Flat Roof Skylights transform any space with natural light. The innovative design of these skylights lets in more daylight, easily sheds rainwater, and stands out as a modern addition to roof surfaces.

Flat Roof Skylights



Standard & Custom Sizes Available

GSM

Fixed SkyMax Skylight

- Covers areas up to 35 square feet – 10 feet at the longest dimension
- Laminated LowE³ Glass, custom glass options available including Hurricane Resistant¹
- Standard 2604 powdered coat finish in VELUX Grey with additional designer colors or copper cladding available
- Custom sizes available; minimum 17 1/2", maximum 120"

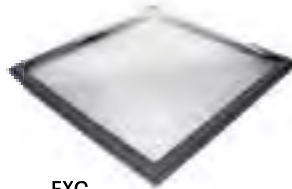

FXG

Fixed Double Dome Acrylic

- Curb-mounted model with VELUX Neutral Grey exterior color
- Encapsulated inner frame is 100% thermally broken
- Standard glazing with clear over clear or clear over white acrylic
- Also available with bronze over clear acrylic and custom sizes¹



CFU/ISU

Fixed CurveTech Glass

- ISU CurveTech top cover with CurveTech glass lets rainwater easily roll off for a clean look while preventing leaks
- Tempered glass top cover is virtually scratch-proof, providing a durable layer of protection
- CFU fixed base unit with laminated glass for added safety, sound control, and thermal protection
- Insulated PVC frame

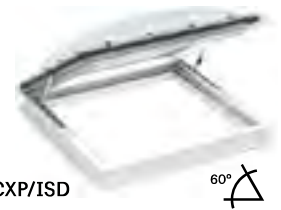

CXP/ISD



Hatch Polycarbonate Dome

- Opens manually up to 60° for roof access
- Highly impact resistant domed polycarbonate outer cover lets rainwater easily roll off for a clean look while preventing leaks
- Inner laminated glass for added safety, sound control, and thermal protection
- Insulated PVC frame

GSM Custom Finish Colors:



VELUX Neutral Grey finish standard. Other custom finish colors available.² Shades and flashing kits are not available with GSM and FXG models.

Standard Sizes	225225	225465	305305	345345	465465	4896	5199
GSM							
FXG							
Outside Curb (W-in. x H-in.)	27 1/2 x 25 1/2	25 1/2 x 49 1/2	33 1/2 x 33 1/2	37 1/2 x 37 1/2	49 1/2 x 49 1/2	48 x 96	51 x 99
Max Skylight Clearance (W-in. x H-in.)	27 1/16 x 27 1/16	27 1/16 x 51 1/16	35 1/16 x 35 1/16	39 1/16 x 39 1/16	51 1/16 x 51 1/16	49 1/4 x 97 1/4	52 1/4 x 100 1/4
GSM SkyMax Fixed						•	•
FXG Domed Fixed	•	•	•	•	•		

Standard Sizes	060060	080080	090060	120090	120120	090090	100100	150100	150150	200100	090120	100100	120120
Rough Opening (W-in. x H-in.)	23 11/16 x 23 11/16	31 9/16 x 31 9/16	35 1/2 x 23 11/16	47 5/16 x 35 1/2	47 5/16 x 47 5/16	35 1/2 x 35 1/2	39 7/16 x 39 7/16	59 1/8 x 39 7/16	59 1/8 x 59 1/8	78 3/4 x 39 7/16	35 7/16 x 47 1/4	39 3/8 x 39 3/8	47 1/4 x 47 1/4
Exterior Frame (W-in. x H-in.)	32 1/16 x 32 1/16	39 15/16 x 39 15/16	43 7/8 x 32 1/16	55 11/16 x 43 7/8	55 11/16 x 55 11/16	43 7/8 x 43 7/8	47 13/16 x 47 13/16	67 1/2 x 47 13/16	67 1/2 x 67 1/2	87 3/16 x 47 13/16	42 1/2 x 54 5/16	46 7/16 x 46 7/16	54 5/16 x 54 5/16
CFU/ISU CurveTech	•	•	•	•	•	•	•	•	•	•			•
CXP/ISD Domed Hatch											•	•	•

¹ Call 1-800-888-3589 for information about custom options. ² Visit commercial.veluxusa.com/products/finishes for full list of GSM finish color options.



Self-Flashed Skylights

The VELUX product line of self-flashed skylights differ from both deck- and curb-mounted skylights because their curb and flashing are built into the skylight and come with a watertight seal. These skylights are ideal for thin roofing materials like asphalt shingles and are ready to install straight out of the box.

SELF-FLASHED SKYLIGHTS

Metal Flashed



QPF

A B

Fixed Skylight System

- Standard white room-darkening solar-powered shade, factory-installed with pre-paired remote¹
- Pre-finished white interior wood frame
- Pre-installed metal flashing designed for sealant based installation

A Add the VELUX App Control system, Gateway + App: Control your VELUX shades anytime, anywhere with your smartphone or smart home device. See page 17

E-Class PVC Flashed

E-Class has been Discontinued - Available While Supplies Last



EVMS

B C D E

Solar-Powered Fresh Air Skylight

- Available in custom sizes only
- Solar-powered battery control system easily opens and closes skylight with remote or smartphone app
- Rain sensor automatically closes skylight at the first sign of rain
- Easy installation, no sealants or mastic required



EV

C D E

Manual Fresh Air Skylight

- Available in custom sizes only
- Manually open and close the skylight with smooth-turning handles or control rods
- Integrated PVC flashing
- Easy installation, no sealants or mastic required



EF

D E

Fixed Skylight

- Available in custom sizes only
- With no mastic, step-flashing, or sealants, skylight is ready to be installed right out of the box in as little as 30 minutes
- Larger glass area delivers up to 22% more daylight compared to similar models



B Wireless remote included. **C** Equipped with insect screen. **D** Available in custom sizes and finish colors. **E** No sealants or flashing required.

Optional Upgrades: Impact Glass* | White Laminated Glass

* Model QPF only.

QPF Standard Sizes	2222	2230	2246	3030	3046	4646
Outside Flashing	29 11/16 x 29 11/16	29 11/16 x 37 3/4	29 11/16 x 53 3/4	37 3/4 x 37 3/4	37 3/4 x 53 3/4	53 3/4 x 53 3/4
Rough Opening/ Finished Frame	22 1/2 x 22 1/2	22 1/2 x 30 1/2	22 1/2 x 46 1/2	30 1/2 x 30 1/2	30 1/2 x 46 1/2	46 1/2 x 46 1/2

E-Class Custom Sizes



EVMS/EV sizing:

- Up to 15 sq ft
- Min RO: 22 1/4" W or H
- Max RO: 48" W or 54" H

EF sizing:

- Up to 23 sq ft
- Min RO: 14 1/2" W or H
- Max RO: 72" W or H

E-Class Custom Finish Colors:

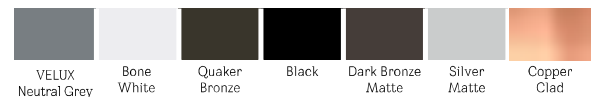

VELUX Neutral Grey is standard. Other custom finish colors are available.²

¹ Other special order shade colors available with extra lead time. ² Visit commercial.veluxusa.com/products/finishes for full list of E-Class finish color options.



Solar Skylight Shades & Manual Roof Window Shades

Solar shades add the ultimate functionality to skylights. Sustainably powered by the sun, solar skylight shades give you control over the amount of light in your home. Use the included remote to easily open and close your shades, or upgrade to our new VELUX Touch Remote for even smarter operation.

Complete the look of your roof window with stylish, manually-operated roof window shades! Available in a variety of styles and colors to match your decor, roof window shades easily glide up and down to let in just the right amount of light for your space.

MORE INFORMATION



SOLAR SKYLIGHT & MANUAL ROOF SHADES

Solar-Powered Skylight Shades

In-Stock Skylight Shade ¹

Room-Darkening, Double-Pleated
Standard with VELUX Skylight System models



1045
White

Special Order Skylight Shade Options ²

Room-Darkening, Double-Pleated



Light Filtering, Single-Pleated



Manual Roof Window Shades

Ships separately from Roof Window

In-Stock Roof Window Shade Options ¹

Room-Darkening, Double-Pleated Light-Filtering, Single-Pleated Venetian



1045
White



1016
White



7001
White

Special Order Roof Window Shade Options ²

Room-Darkening, Double-Pleated

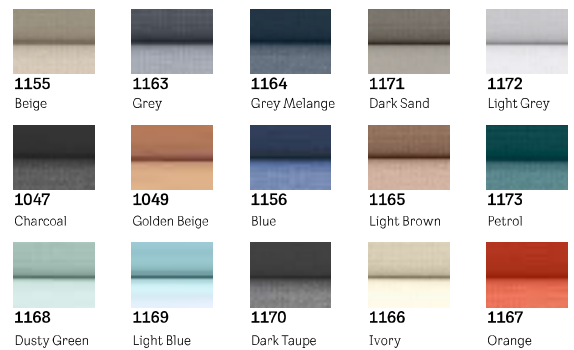

Light Filtering, Single-Pleated



¹In-Stock: Solar skylight shades are sold separately (2-4 business days) and/or factory installed as a part of VELUX Skylight Systems (see skylight product pages 6-9). Custom sizes are sold separately as special order. Manual roof window shades not eligible for factory installation.
²Special Order: No factory installation for special order skylight or roof window shades. Shades ship separately; skylights 14 business days and roof windows up to 8 weeks. GDL requires two shades, one each for top and bottom windows. ³Includes pattern design.



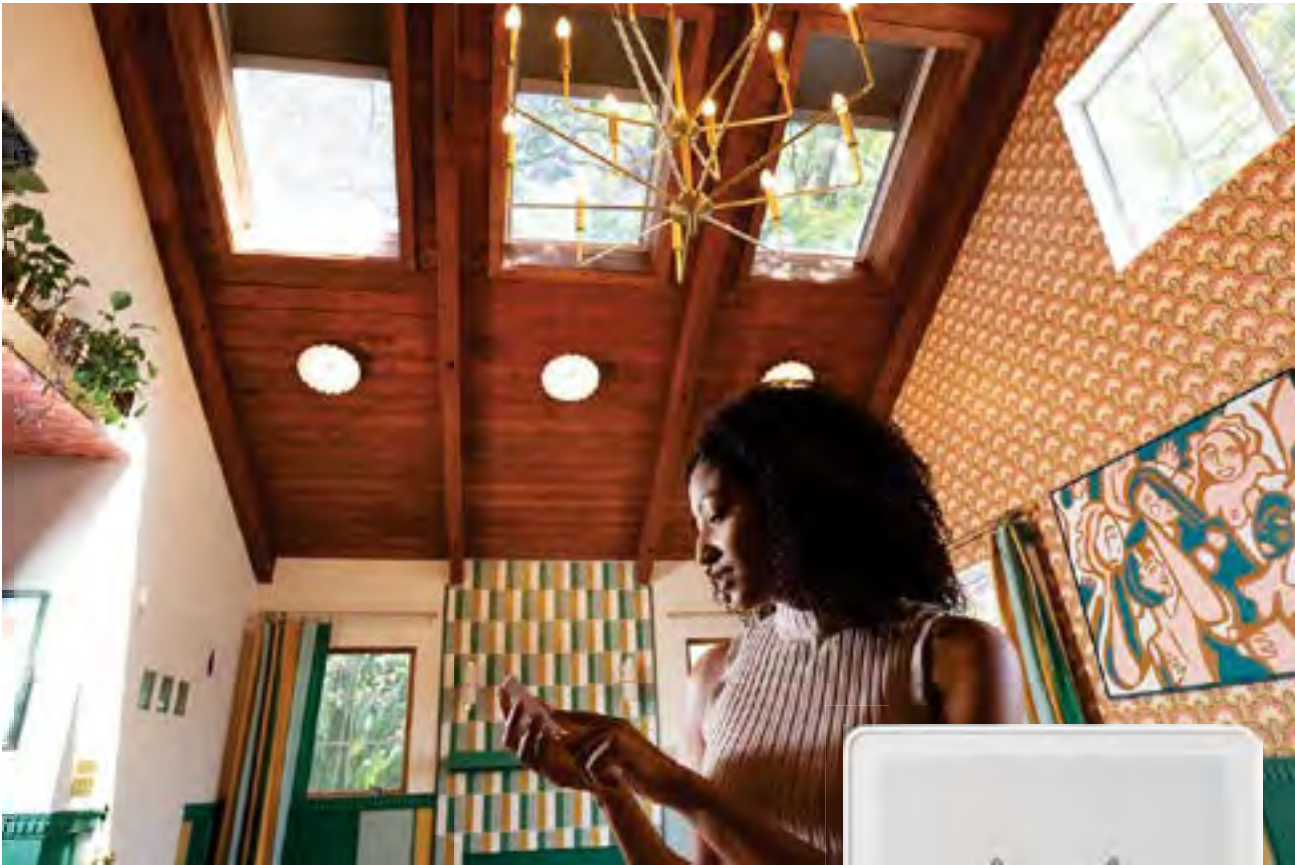

Simple control of all VELUX skylights and shades with one remote.



The Touch remote controls both skylights and shades, featuring ventilation timing and programmable presets.

We believe it should be easier to create your perfect home environment with VELUX skylights and shades. Now, with VELUX Touch, you only need to reach for one remote to take control of every skylight and shade you install. Talk about indoor comfort right at your fingertips!

- Remote operation in room where your skylights are installed
- Operate multiple products at once
- Group skylights and shades to operate together
- Set the ventilation timer for regular automated home airing
- Lock home option to securely close all your skylights automatically
- Preset shade and skylight positions for even easier operation

MORE INFORMATION



SKYLIGHTS & SHADES REMOTE

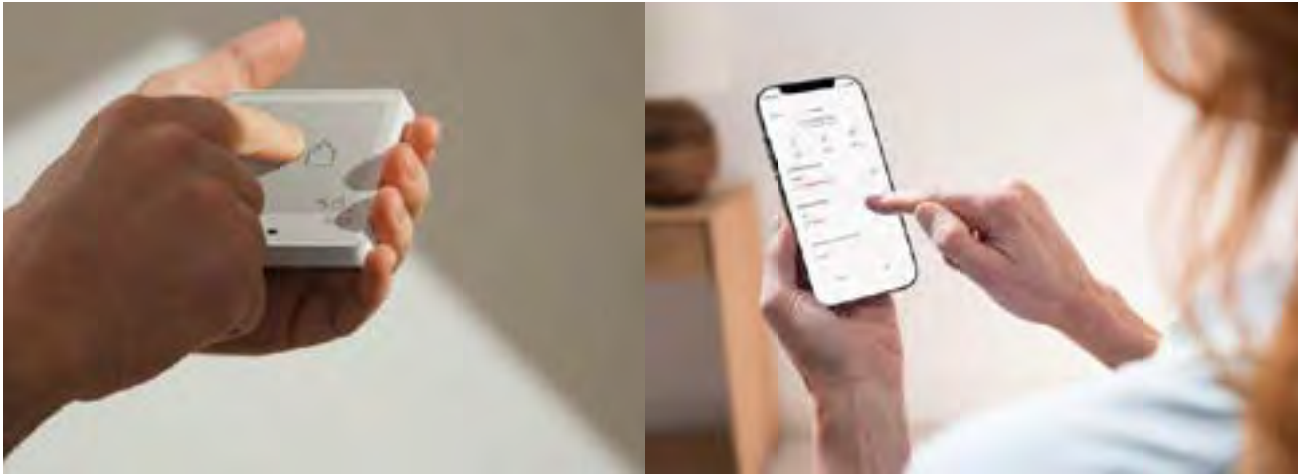

Remote Comparison



	VELUX Wall Switch	VELUX Touch	VELUX App Control	VELUX ACTIVE
	For customers who want simple control over a single or group of skylights or shades in one room.	For customers who want simple control over multiple skylights and shades with one remote.	For customers who wish for more benefits and smartphone control without full automation.	For customers who wish to improve indoor air quality while gathering insights with smart automated ventilation and climate control.
Price	Included with Product	\$	\$	\$\$
Remote Operation Inside the Room	✓	✓	✓	✓
Remote Operation from Anywhere			✓	✓
Operate Multiple Ungrouped Products		✓	✓	✓
Requires Wi-Fi Connection			✓	✓
Compatible with Apple HomeKit® and Google Assistant™			✓	✓
Group Products		✓	✓	✓
Ventilation Timer		✓	✓	✓
Lock Home Option (close all skylights)		✓	✓	✓
Accessible to All Household Members	✓	✓	✓	✓
Scheduling to Personal Preferences			✓	✓
Voice Control			✓	✓
Sensor-based Automation				✓
Use of Weather Data				✓
Live Indoor Sensor Data				✓







Roof Windows

VELUX Roof Windows are installed within reach and manually open to let fresh air flow in while maximizing the amount of natural light in a space. Perfect for loft conversions and attic spaces, roof windows offer panoramic views, natural ventilation, and increased energy efficiency.

VIEW FULL BROCHURE



Roof Windows

 <p>GPU</p>	 <p>GGU</p>	 <p>GXU</p>	 <p>GDL</p>
<h3>Top-Hinged</h3> <ul style="list-style-type: none"> · Innovative top control bar allows for lower installation, providing excellent views while standing or seated · Convenient bottom handle for simple operation within reach · Unique ventilation flap with built-in reusable air filter allows fresh, filtered air through with the window closed · Interior wood frame with white polyurethane finish 	<h3>Center-Pivot</h3> <ul style="list-style-type: none"> · Convenient and simple to operate, even with furniture placed beneath · Easy to open and quick to close with the innovative top control bar · Lower installation allows for more flexibility and better views while standing or seated · Unique ventilation flap allows fresh, filtered air through with the window closed · Interior wood frame with white polyurethane finish 	<h3>Roof Access</h3> <ul style="list-style-type: none"> · Opens wide for easy access to the roof for repairs, maintenance, emergency, and egress · Greatly increase the amount of natural light and fresh air in your rooms · Sleek outer appearance blends in with your roofline · Innovative locking device keeps window open so it won't fall shut · Interior wood frame with white polyurethane finish 	<h3>Balcony</h3> <ul style="list-style-type: none"> · Easily transforms from roof window to balcony in seconds · Provides abundant daylight and great floor-to-ceiling views · Unique ventilation flap allows fresh, filtered air through with the window closed · Balcony fits flush with the roof when closed for a sleek exterior look · Lacquered wood interior

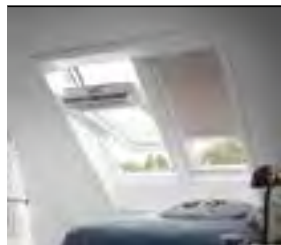

Add Shades!

Roof windows are compatible with VELUX manual shades for ultimate light control.



White Venetian shades stocked. Shades ship separately from Roof Window. Special order colors available, see page 15.

Standard Sizes	CK02	CK04	CK06	FK04	FK06	FK08	MK04	MK06	MK08	MK10	PK06	PK08	PK10	SK06	SK08	UK04	UK08	MK19	PK19
Rough Opening (W-in. x H-in.)	22 ¹ / ₈ x 31 ¹ / ₈	22 ¹ / ₈ x 39	22 ¹ / ₈ x 46 ⁷ / ₈	26 ¹ / ₂ x 39	26 ¹ / ₂ x 46 ⁷ / ₈	26 ¹ / ₂ x 55 ¹ / ₂	30 ¹¹ / ₁₆ x 38 ¹ / ₂	30 ¹¹ / ₁₆ x 46 ³ / ₈	30 ¹¹ / ₁₆ x 55 ¹ / ₁₆	30 ¹¹ / ₁₆ x 63	37 ¹ / ₁₆ x 46 ³ / ₈	37 ¹ / ₁₆ x 55 ¹ / ₁₆	37 ¹ / ₁₆ x 63	44 ⁷ / ₈ x 46 ³ / ₈	44 ⁷ / ₈ x 55 ¹ / ₁₆	53 ¹ / ₄ x 39	53 ¹ / ₄ x 55 ¹ / ₂	33 ¹ / ₁₆ x 101	39 ³ / ₈ x 101
GPU Top-Hinged		•	•				•	♦	♦				♦	♦				♦	
GGU Center-Pivot	•	•	•	•	•	•	•	•	•	•	•	•	•	•	•	•	•	•	•
GXU Roof-Access			•		♦														
GDL Balcony																		♦	♦

♦ Satisfies most egress requirements. Consult local code officials regarding egress requirements as they may vary by jurisdiction.

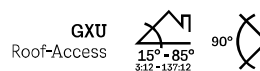
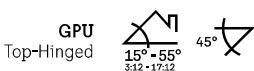



Sun Tunnel® Skylights

Adding Sun Tunnel skylights is a cost-effective way to add natural light to areas that need a brighter, more vibrant appearance. With a variety of dome and flat glass options to collect daylight on the roof and their pre-fabricated light tube, Sun Tunnel skylights are quick and easy to install. Not to mention, rigid tube models come with a 20-year tube warranty.

VIEW FULL BROCHURE



Domed

Flat Glass



TGF (flex) / TGR (rigid)

Low-Profile

- Angled dome is ideal for south-, west-, and east-facing roofs
- Parallel design to blend with roofline

TMF (flex) / TMR (rigid)

Pitched

- Raised dome allows for consistent light distribution throughout the day
- Provides straighter tube run through most roof pitches

TCR

Curb-Mount

- One-piece metal, curb-mounted counterflashing
- Ideal for low roof slopes, and tile or metal roofs

TLR

Low-Profile

- Low profile glass design for a sleek appearance
- Perfect where local ordinances prohibit domes on roofs

TZRQ

Pan-Flushed

- For shingle roofs
- Glass options include tempered **fire resistant** diamond wire or laminated **hurricane**

TZR / TZRL

Curb-Mount

- TZR for tile or flat roofs; TZRL includes flashing kit for shingle roofs
- Glass options include tempered **fire resistant** diamond wire or laminated **hurricane**

Accessories:

Free light.
Day or night.



Designed to fit inside the rigid tube of a VELUX Sun Tunnel® skylight, the **VELUX Solar Night Light** gives off a soft, soothing glow from above when natural light isn't available. The night light's solar panel collects available sunlight, even on cloudy days, to power its rechargeable batteries.

Ceiling Rings and Frosted Diffusers

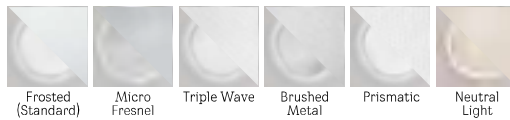

Electric Light Kit



Energy Kit



Daylight Controller



Other Accessories: Additional rigid tube sections and elbows, suspension wire kit, exterior fire band, vapor barrier, tile roof flashing kits.

Standard Sizes	TGF 014	TGF 022	TGR / TMR 010	TGR / TMR 014	TGR 022	TMF 014	TCR 014	TLR 014	TZRQ 014	TZR 014	TZRL 014
Roof Pitch	14° - 60° 3:12 - 20:12	14° - 60° 3:12 - 20:12	14° - 60° 3:12 - 20:12	14° - 60° 3:12 - 20:12	14° - 60° 3:12 - 20:12	14° - 60° 3:12 - 20:12	0° - 60° 0:12 - 20:12	14° - 60° 3:12 - 20:12	10° - 60° 2:12 - 20:12	0° - 60° 0:12 - 20:12	10° - 60° 2:12 - 20:12
Rough Opening – Ceiling (Inches)	15 1/4	22 3/4	11 1/4	15 1/4	22 3/4	15 1/4	15 1/4	15 1/4	15 1/4	15 1/4	15 1/4
Rough Opening – Roof Deck* (W-in. x H-in.)	14 1/2 x 18	22 1/2 x 26	12 1/2 x 16	14 1/2 x 18	22 1/2 x 26	14 1/2 x 20	–	14 1/2 x 17 3/4	14 1/2 x 14 1/2	14 1/2 x 14 1/2	14 1/2 x 14 1/2
Outside Curb Dimensions** (W-in. x H-in.)	–	–	–	–	–	–	20 3/8 x 20 3/8	–	–	17 1/2 x 17 1/2	17 1/2 x 17 1/2
Tube Length Included with Kit (Feet)	8	8	4	4	4	8	4	4	4'4"	5'4"	5'4"
Maximum Recommended Install Length (Feet)	8	12	20	30	40	8	30	30	30	30	30

* Roof deck rough opening height dependent on roof pitch, refer to installation instructions for proper measurement. ** Including roofing materials.

Fire resistant tempered diamond wire glass meets Class A Burn Brand Test ASTM E108. Laminated hurricane glass meets Florida Product Approval #6393.



Architectural Skylights

The VELUX line of architectural skylights is made up of lightweight, metal-framed structural skylights available in fully customizable configurations, finish colors, and glazing options.

As part of the architectural line, our modular skylight system can be configured to a range of different daylight solutions while offering several features for climate control, ventilation, and shading.

Custom Structural Skylights



Square Pyramid



Polygonal Pyramid



Extended Pyramid



Single Pitch



Double-Pitch



Low Profile

- Create spectacular daylighting applications with unlimited design capabilities
- Lightweight, metal-framed skylights capable of spanning up to 40 feet wide
- Insulated glass panels help control heat gain and loss in all types of weather
- Available in a wide variety of high-performance glass and finish colors

MORE INFORMATION



VELUX Modular Skylights – VMS



Longlight



Wall-Mounted Longlight



Step Longlight



Ridgelight



Step Ridgelight



Northlight

- Prefabricated components ensure a quality build, 100% water tightness, and fast, easy installation
- Available in a variety of configurations with both venting and fixed modules
- Includes electronic control system with wind and rain sensor
- Optional roller blinds are available to control daylight and solar heat gain

MORE INFORMATION



Venting Module



Fixed Module



3 TYPES OF INSTALLATION

3 Types of Installation

VELUX offers three skylight installation methods. To know which is right for your home, your installer or roofer will evaluate your roof pitch, roof material, ceiling type, and whether you're installing new skylights or replacing old ones.

Deck-Mounted Skylights

Skylight is nailed directly to the roof deck for a sleek, low-profile design

Ideal for new home constructions or new skylight cut-ins



14°-85°
3:11-17:12

Curb-Mounted Skylights

Skylight is installed on top of a site-built curb or frame attached to the roof

Most common installation method for low-pitch or flat roofs

Ideal for replacing existing skylights



0°-50°
0:11-20:12

Self-Flashed Skylights

Flashing is integrated into the skylight, so no additional kit is needed

Skylight sits directly over rough opening in the roof and is sealed into place



10°-60°
2:11-10:12

Flashing Systems

VELUX Skylight Flashing Kits are a crucial part of our complete system designed to shed water without relying on sealants that can break down over time.

Deck-Mounted Flashing Systems

Deck-mounted flashing systems are comprised of a pre-attached deck seal, adhesive underlayment, and engineered flashing, ensuring a weathertight fit.

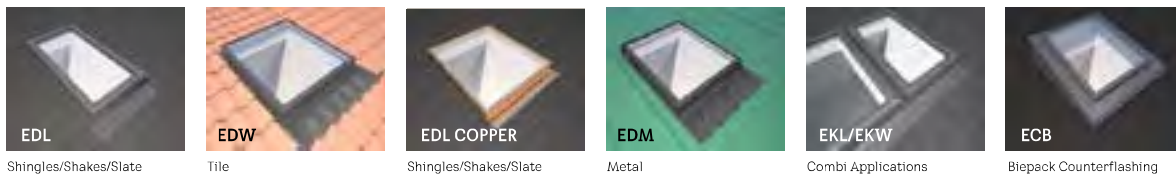

EDL
Shingles/Shakes/Slate

EDW
Tile

EDL COPPER
Shingles/Shakes/Slate

EDM
Metal

EKL/EKW
Combi Applications

ECB
Bi-pack Counterflashing

Curb-Mounted Flashing Systems

Curb-mounted flashing systems consist of a pre-attached skylight gasket, adhesive underlayment, and engineered flashing, ensuring a weathertight fit.



ECL
Shingles/Shakes/Slate

ECW
Tile

LEARN MORE





The VELUX Skylight Guarantee

VELUX skylights and flashing kits work together to ensure water protection that holds up in all weather conditions.

Our skylight warranty is our commitment that VELUX skylights installed with our flashing will stand strong in all types of weather. We're able to make this commitment with a 10-year installation warranty backed by our patented three layers of water protection on deck- and curb-mounted skylights.



- 1 Pre-Attached Seal**
Pre-attached deck seal (deck-mounted) or gasket (curb-mounted) provides a tight seal for leak-proof installation.
- 2 Adhesive Underlayment**
Adhesive underlayment for secondary water protection against the harshest weather conditions.
- 3 Engineered Flashing**
Engineered flashing for easy installation and primary water protection. See page 24 for flashing systems.



A Skylight for Every Ceiling

Flat, Attic, Cathedral, Vaulted

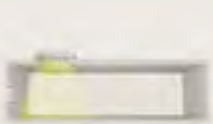

Flat Ceiling

If you have flat ceilings, once your skylight is set outside, your installer will construct a drywall light shaft inside. This shaft directs daylight to the room below while hiding the attic space between your ceiling and roof.

Cathedral Ceiling

The advantage to cathedral ceilings during skylight installation is that without attic space between the roof and your home's interior, there's no need for a light shaft. So, once your skylight is installed, the work's all done.

Vaulted Ceiling

Although similar to a cathedral ceiling, vaulted ceilings feature a single sloping side or arched slope. This style may require a light shaft to be created between your ceiling and roof for the skylight.

Attic

Even if your attic has obstacles like HVAC units, you can still add natural light to your home. Sun Tunnel® Skylights fit between ceiling supports, allowing light to fill the space below uninhibited.

Flat Roof & Ceiling

Like a cathedral ceiling, flat ceilings under flat roofs can easily accommodate both skylights and Sun Tunnel® skylights. Depending on your attic space, a small light shaft may be needed to complete the installation.



A SKYLIGHT FOR EVERY CEILING

ENERGY STAR®

One of the most straightforward ways to help meet energy codes as a builder or architect, while still designing bright, airy buildings, is to specify ENERGY STAR® certified products.



Many VELUX residential products are ENERGY STAR® certified, which means they meet energy efficiency standards set by the US Environmental Protection Agency (EPA). In order to be ENERGY STAR® certified, fenestration products must have their U-factor, Visible Transmittance, and Solar Heat Gain Coefficient ratings independently tested and approved under the FenStarSM Certification Program of the National Fenestration Rating Council (NFRC) to qualify.

By using ENERGY STAR® certified products, architects and builders can use skylights to bring much needed daylight and fresh air inside, allowing them to create more attractive buildings and more livable spaces while still meeting local energy codes.

In warmer climates, there is great potential for lighting energy savings by using emerging control technologies like VELUX ACTIVE or more effective daylighting products like VELUX skylights with shades and Sun Tunnel® skylights.

Code Compliance

VELUX offers a broad array of skylights, roof windows, and Sun Tunnel skylights that meet the applicable performance requirements and testing and labeling standards written into US Model Codes:

- 2021 IBC (International Building Code)
- 2021 IRC (International Residential Code), and
- 2021 IECC (International Energy Conservation Code),
- As well as local and regional codes based on the above codes.

Additionally, electrical components built into VELUX products are UL listed.

Standard VELUX residential skylights and Sun Tunnel products are tested to meet North American Fenestration Standards (NAFS), also known as AAMA/WDMA/CSA 101/IS.2/A440. Copper-clad versions may not exceed these requirements but do meet other standards required of them.

To verify these attainments on-site, the products are shipped with all required labels to expedite the inspection and final acceptance process. VELUX confidently certifies through these labels that only products consistent with the tested specimens are sent to the job.

Warranty

For over 80 years, VELUX has been dedicated to producing skylights and roof windows that are synonymous with quality and reliability. Our commitment to you does not end once your skylight is installed.

The VELUX deck- and curb-mounted product family carries a 10-year installation warranty when installed with VELUX flashing, plus 20 years on glass seal failure, 10 years on product, and 5 years on shades and controls.

The 10-year installation warranty does not apply to VELUX products purchased prior to January 1, 2010. Other exclusions apply, see full warranty for details.

MORE INFORMATION



Testing Data

VELUX rigorously tests the materials of our skylights so you can rest assured that the products installed in your home are safe.

For our most up-to-date data, visit: veluxusa.com/testing-data

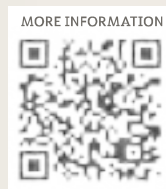

NOTICE: ALL GLASS MAY BE SUBJECT TO UNEXPECTED AND SPONTANEOUS BREAKAGE in rare circumstances due to imperfections in the glass that are undetectable during the manufacturing and inspection process by the manufacturer of the glass and VELUX.

VELUX offers the choice of laminated or tempered glass skylights. Impact glass and comfortplus glass are all types of laminated glass. Comfort glass is a type of tempered glass. Laminated glass is a combination of two or more glass sheets with one or more interlayers of plastic (PVB) or resin. In case of breakage, the interlayer is designed to hold the fragments together. Tempered glass does not contain an interlayer to hold the fragments together. Instead, tempered glass is designed to break into small, pebble-like pieces. When tempered glass breaks, pieces of glass come loose and may strike an individual.

CONSULT LOCAL REGULATIONS AND/OR BUILDING MATERIAL CONSULTANTS TO DETERMINE WHICH TYPE OF GLASS IS RIGHT FOR YOU OR IF LAMINATED GLASS IS REQUIRED IN YOUR APPLICATION.

All VELUX skylights, roof windows, Sun Tunnel® skylights, flashing kits and shades must be purchased through a qualified VELUX dealer. Please see the "Where To Buy" section of veluxusa.com website for a list of VELUX dealers near you.

Transforming spaces since 1941. For over 80 years, VELUX has helped people envision and achieve the transformation of spaces using daylight and fresh air through the roof. Our product program includes skylights, Sun Tunnel® skylights, decorative shades and roof windows, as well as installation and smart homes solutions. By creating brighter, healthier, more sustainable places to live, work, learn, and play we enable a better everyday life for people around the world. We work globally with sales and manufacturing operations in more than 40 countries and around 11,500 employees worldwide. The VELUX Group is owned by VKR Holding A/S, a limited company wholly owned by non-profit, charitable foundations (THE VELUX FOUNDATIONS) and family. For more information, visit veluxusa.com.



MM040126WC